

LENS

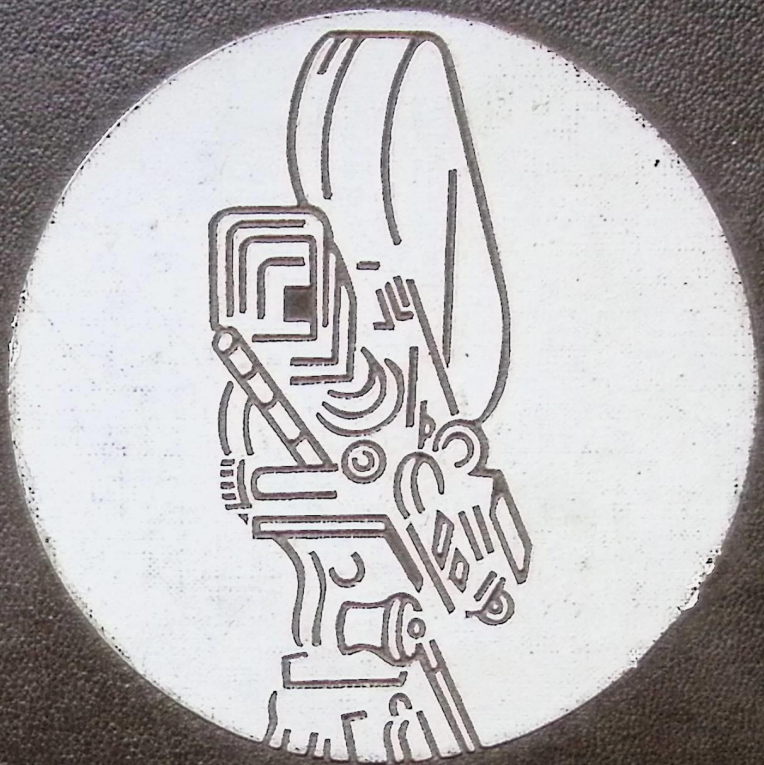

1957





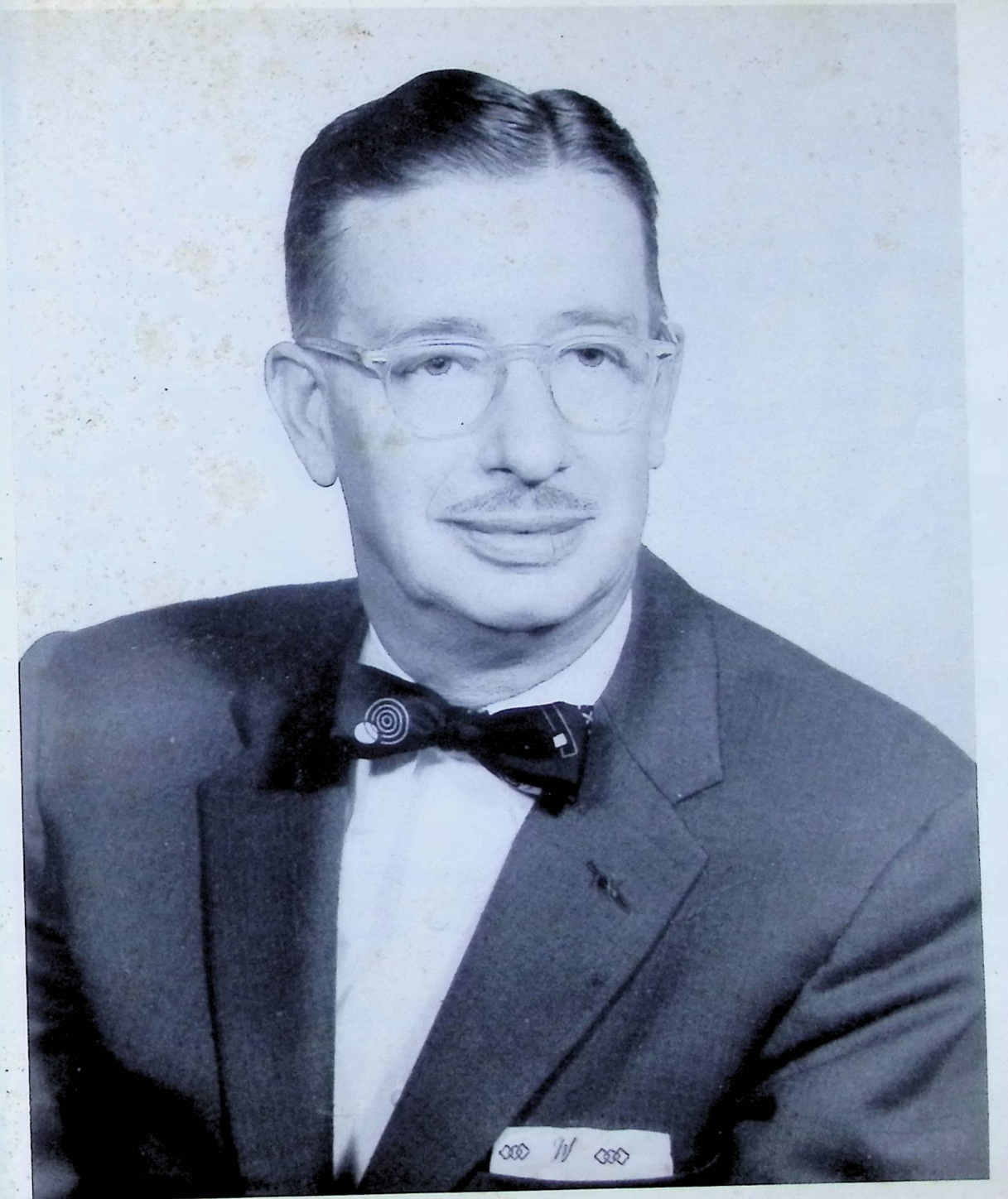

a m  
fine  
frie  
hun  
ger  
hav  
Wi  
qu  
Ch

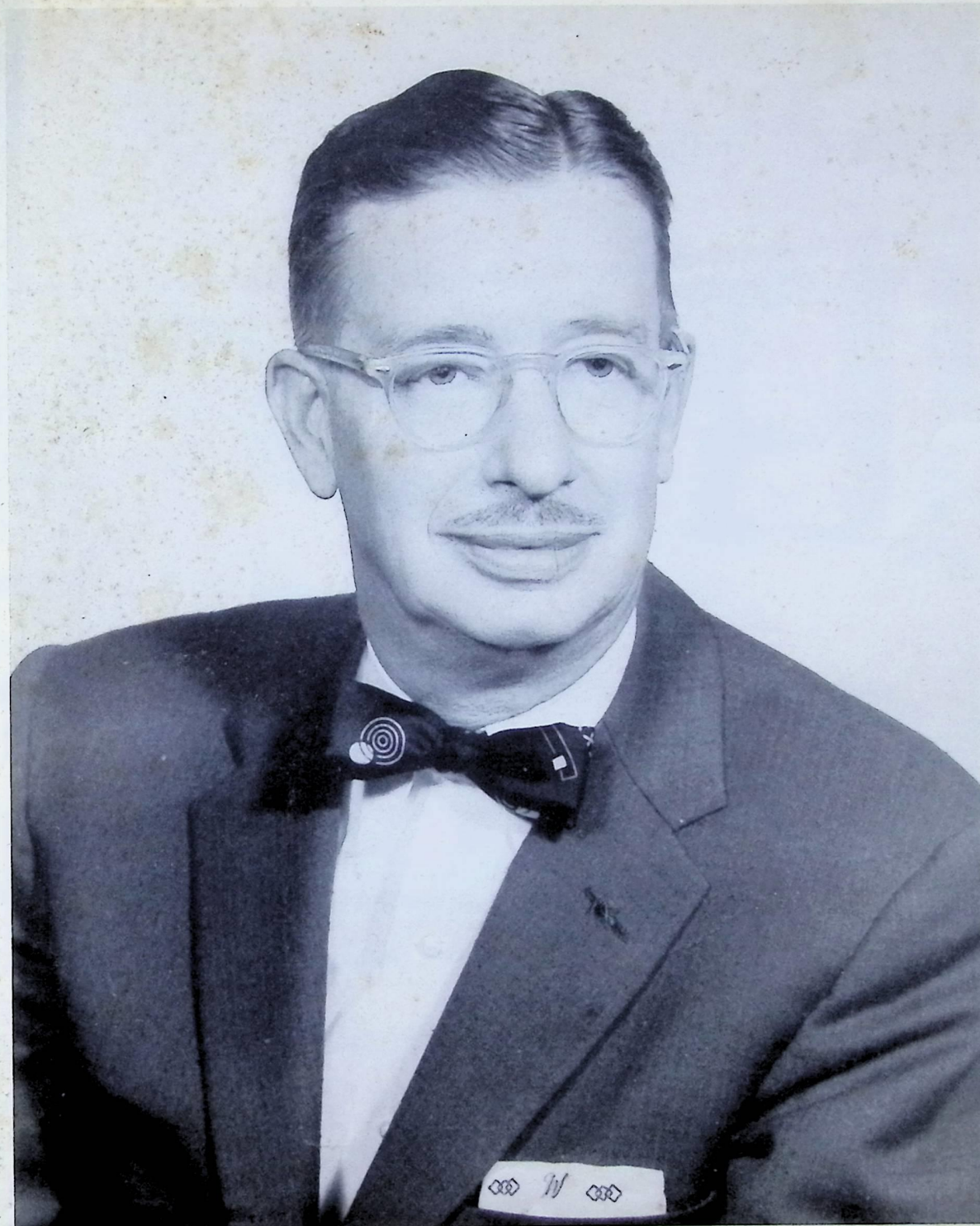

## DEDICATION

This book is respectfully dedicated to a man who is recognized not only as a fine teacher but a warm, understanding friend. His prankish smile and ready humor, his stimulating vitality, and his genuine interest in school activities, have endeared him to the hearts of every Willoughby High School student.

In appreciation of these outstanding qualities we dedicate the Lens to Mr. Chester B. Wike.



# CINEMASCOPE

edition of the

1957

# LENS

Phyllis Patterson, Editor

# CINEMASCOPE

edition of the

1957

# LENS

Cynthia Bouton . . . Club Editor  
Bobbi Widgren . . . Assistant  
Ann Alpeter . . . Assistant  
Bob McLean . . . Layout Editor  
Sue Hengst . . . Artist  
Nancy Williams . . . Photo Editor  
Judy Rogers . . . Senior Editor  
Carolyn Blazy . . . Assistant  
Vicky Tyler . . . Underclass  
Nicky Lippens . . . Editor  
Jim Heltman . . . Sports Editor  
Bob Doyle . . . Assistant  
Gail York . . . Features Editor  
Dick Mullen . . . Advertising  
Donna Hogg . . . Assistant  
Anita Shaw . . . Secretary  
Judy Stendel . . . Typist  
Joan Nelson . . . Business  
Manager

Phyllis Patterson, Editor

# TABLE OF CONTENTS

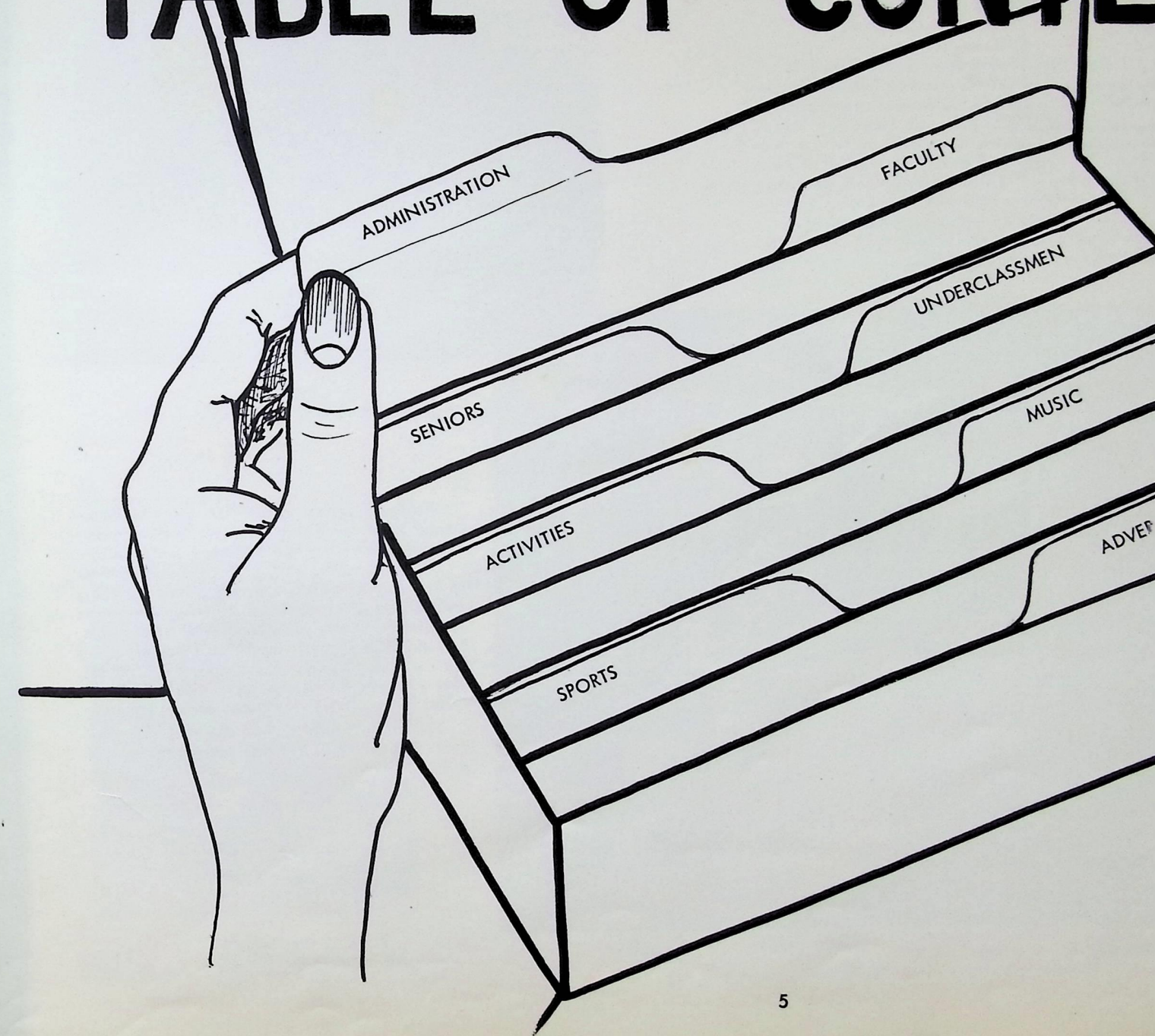



# TABLE OF CONTENTS

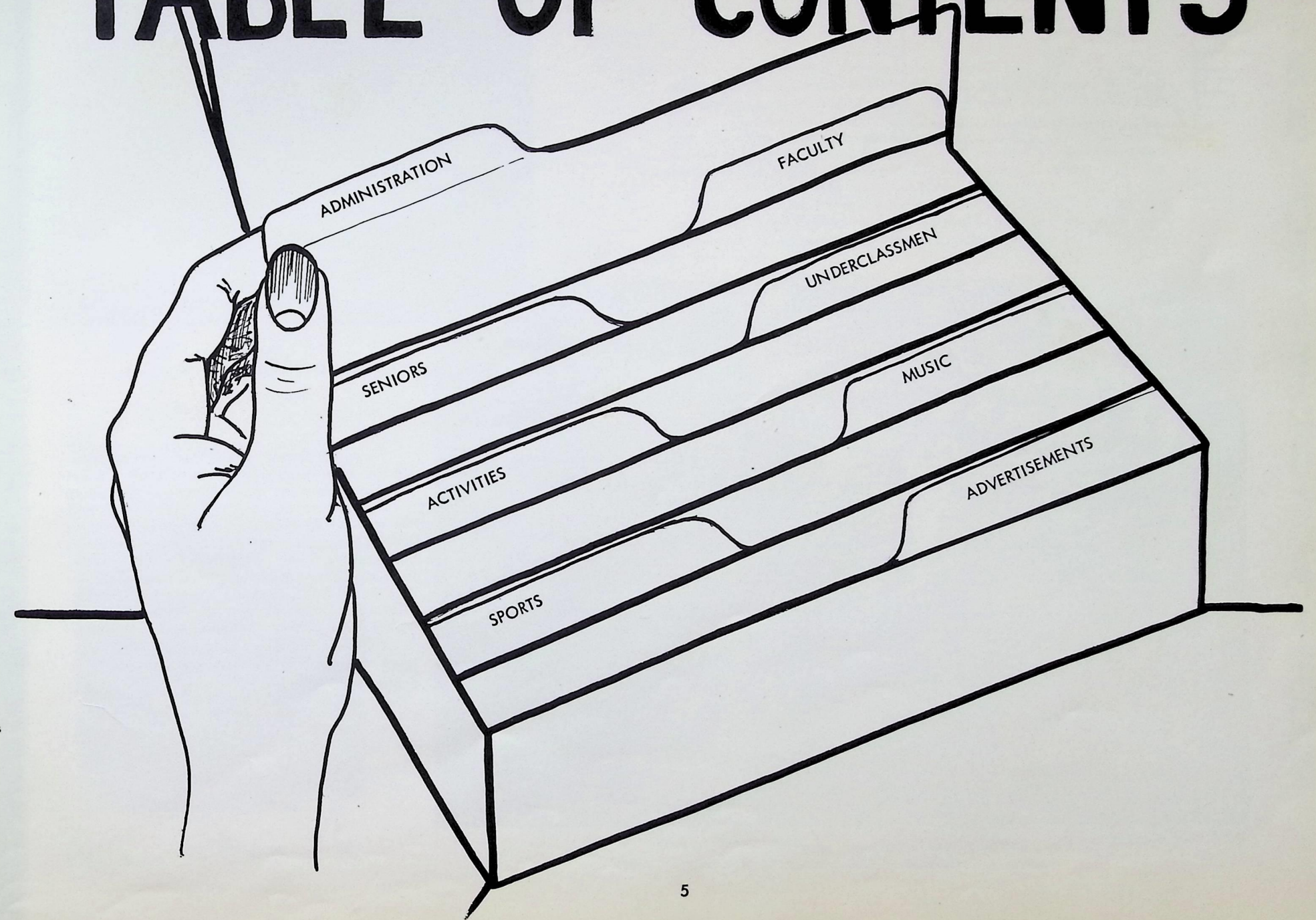

BOARD OF EDUCATION

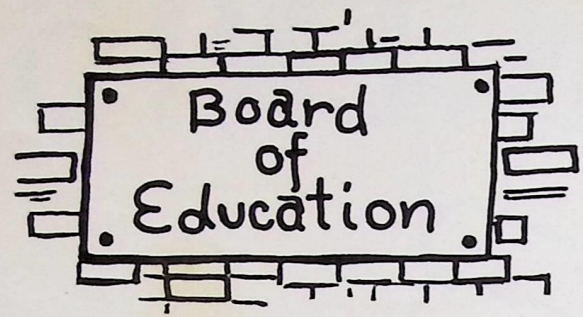

*O. H. Farrar*

The administration of Willoughby mented for the splendid way in which and sometimes confusing problems that year. This year, the year of the split and the long afternoons posed many needed prompt and accurate solutions. were met and solved with the result t enjoyed a fine year free from disruptio  
Principal O. H. Farrar, Assistant deans Miss Janet Hallock and Mr. Ar gratulated for foresight and effort on body.

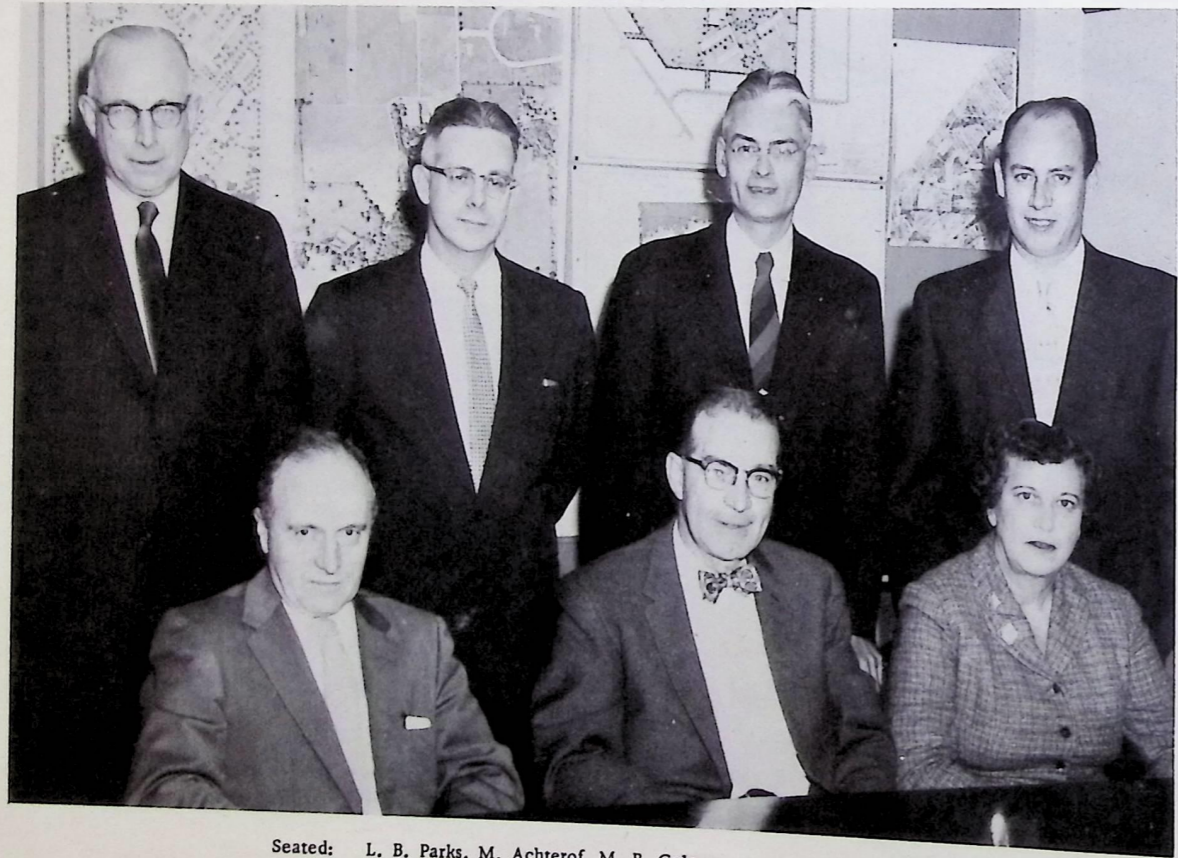

Seated: L. B. Parks, M. Achterof, M. B. Cole.  
Standing: J. B. Woodside, W. McLaughlin, F. M. Williams, J. T. Smith.

No large school system can function without the able leadership and co-operative effort of the superintendent and the board of education. Superintendent, Mr. J. B. Woodside, and the Willoughby-Eastlake School Board members worked long and sometimes inconvenient hours planning the future development of our schools. In recognition of their inestimable contributions we, the student body of Willoughby High School, offer a hearty "thank you" and extend our best wishes for a successful future.

The officers are: L. Beaumont Parks, president; F. M. Williams, vice president; J. T. Smith, clerk.

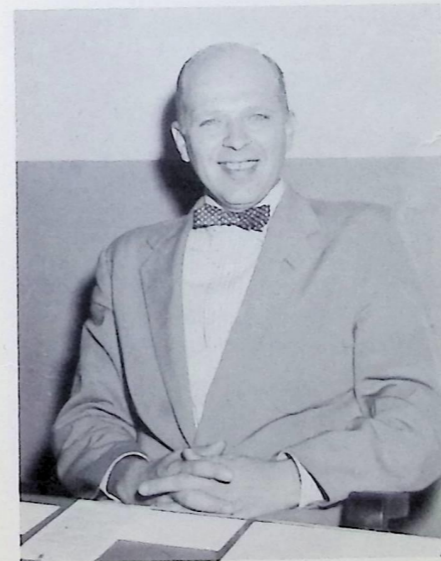

*Milan Stefauik*



*Janet T. Hallock*

ion



L. B. Parks, M. Achterof, M. B. Cole.  
J. B. Woodside, W. McLaughlin, F. M. Williams, J. T. Smith.

No large school system can function without the able leadership and co-operative effort of the superintendent and the board of education. Superintendent, Mr. J. B. Woodside, and the Willoughby-Eastlake School Board members worked long and sometimes inconvenient hours planning the future development of our schools. In recognition of their inestimable contributions we, the student body of Willoughby High School, offer a hearty "thank you" and extend our best wishes for a successful future.

The officers are: L. Beaumont Parks, president; F. M. Williams, vice president; J. T. Smith, clerk.



*O. H. Farrar*

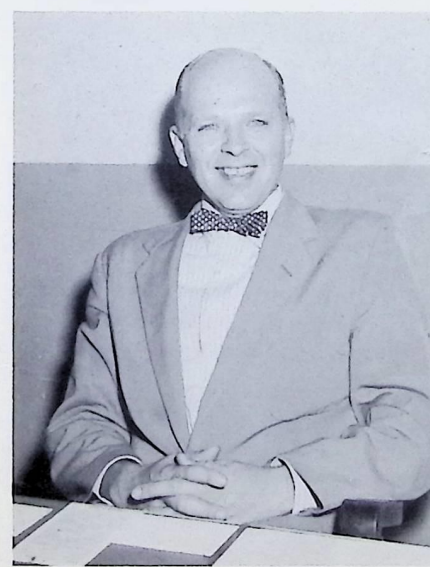

*Milan Stefanik*



*Janet T. Hallock*



*Arthur S. Holloway*

The administration of Willoughby High School is to be complimented for the splendid way in which it managed the many difficult and sometimes confusing problems that are part of any normal school year. This year, the year of the split sessions, the sunrise classes, and the long afternoons posed many additional problems which needed prompt and accurate solutions. These perplexing difficulties were met and solved with the result that both students and faculty enjoyed a fine year free from disruption and conflict. Principal O. H. Farrar, Assistant Principal Milan Stefanik, the deans Miss Janet Hallock and Mr. Arthur Holloway, are to be congratulated for foresight and effort on behalf of the entire student body.

F  
A  
C  
U  
L  
T  
Y



Marshall B. Cripp



John Platz



James H. Smeed



Elizabeth Puyan



Alele Knight

H



Madeleine Ficker



John R. Koet



Edmund W. Edmunds



Cleo Sawyer

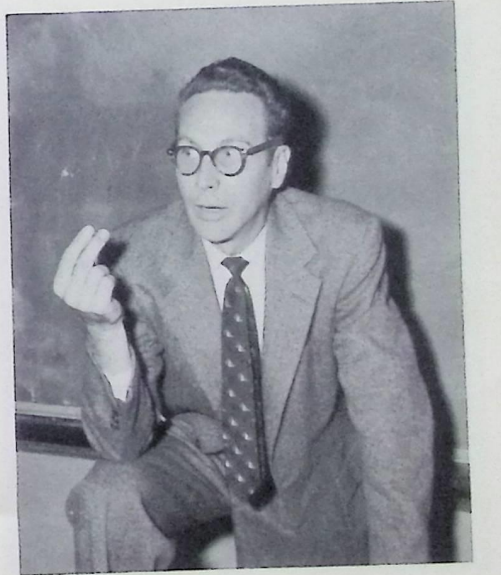

Leonard Slominski

K



*John Platz*



*James H. Smeed*



*Elizabeth Ryan*



*Adele Knight*

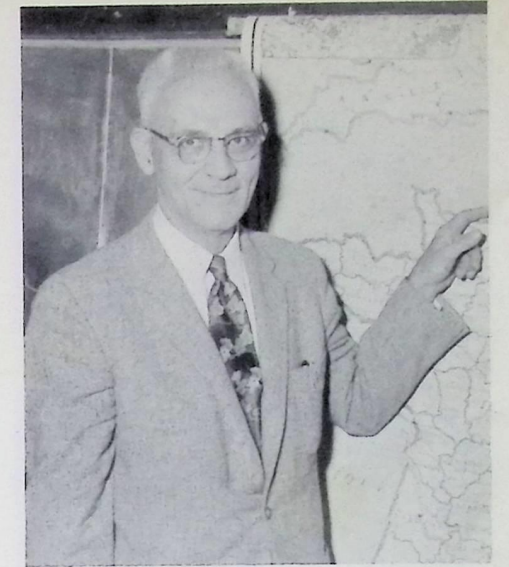

*Herbert Lake*



*John R. Kost*



*Edmund W. Edmunds*



*Cleo Sawyer*

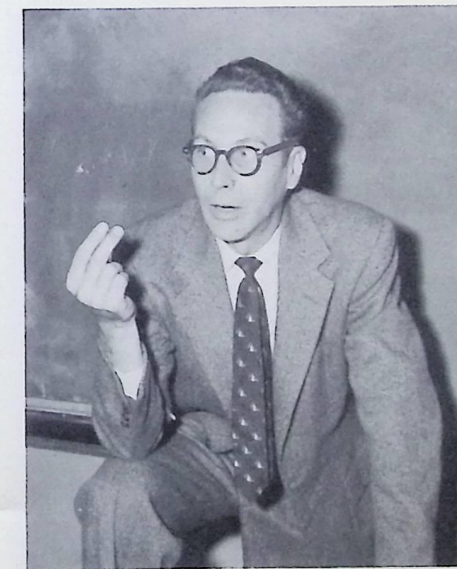

*Leonard Slominski*



*Kenneth Potter*

F  
A  
C  
U  
L  
T  
Y

F  
A  
C  
U  
L  
T  
Y



*Stella Raing*



*Beverly Oliver*



*Merion Riemann*



*Grace Beckard*



*Norman Moyer*

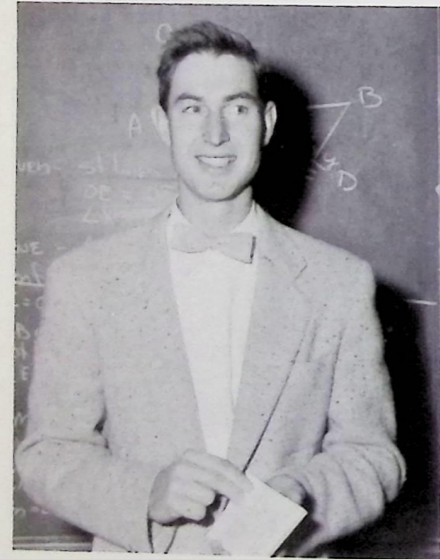

*Chet Minich*

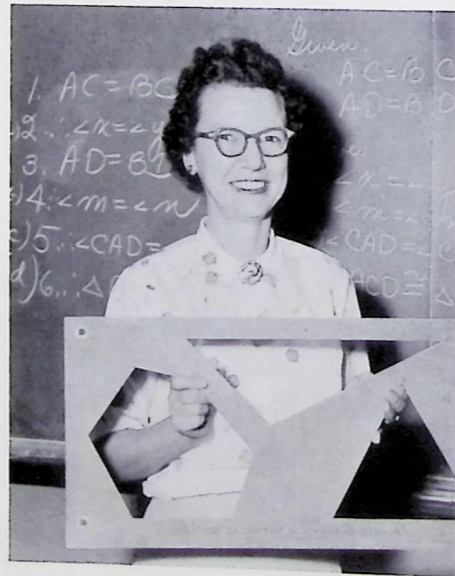

*Alice Randles*

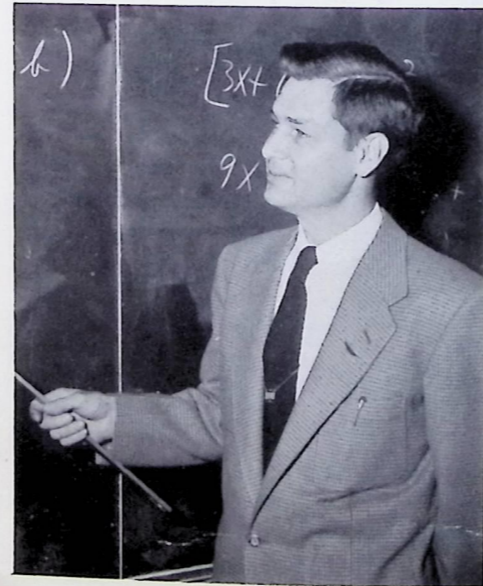

*Richard C. Miller*



*Chet Wike*

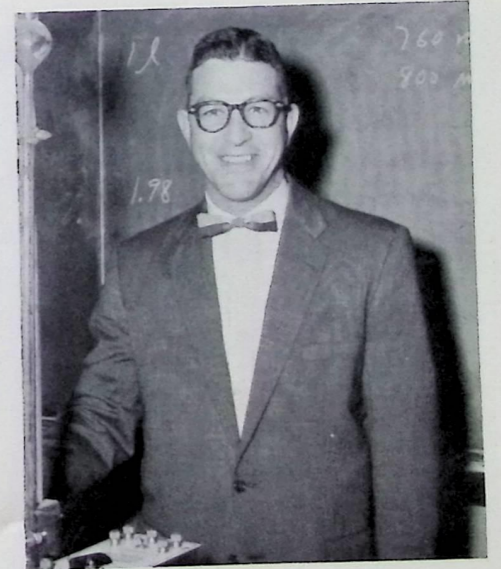

*Denny J. Hewitt*



*Beverly Oliver*



*Merin Rimann*



*Grace Reckard*



*Norman Moyer*



*Chris Artale*

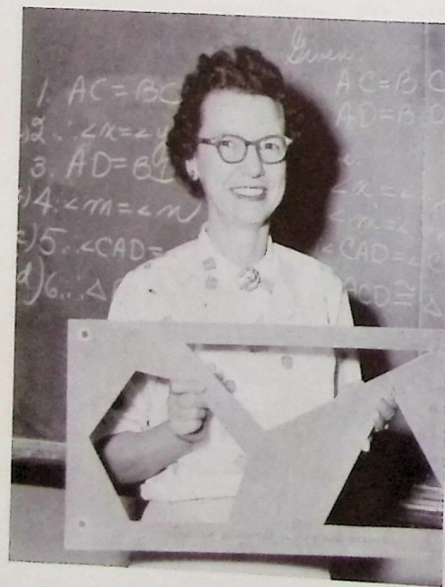

*Alice Randles*

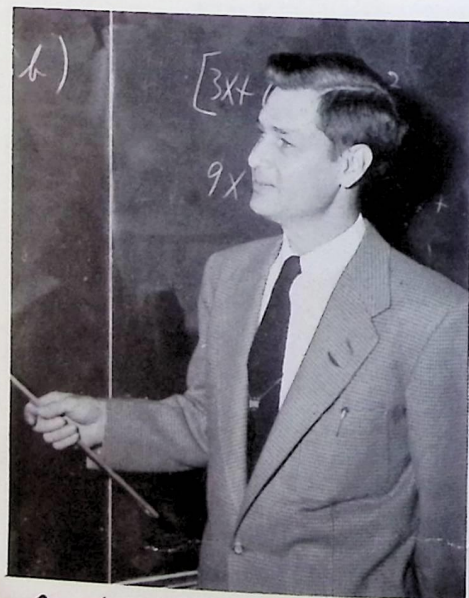

*Richard C. Miller*



*Beth Wike*



*Denny J. Hewitt*



*Raymond Hoffman*

F  
A  
C  
U  
L  
T  
Y

F  
A  
C  
U  
L  
T  
Y



*Lucy Patterson*

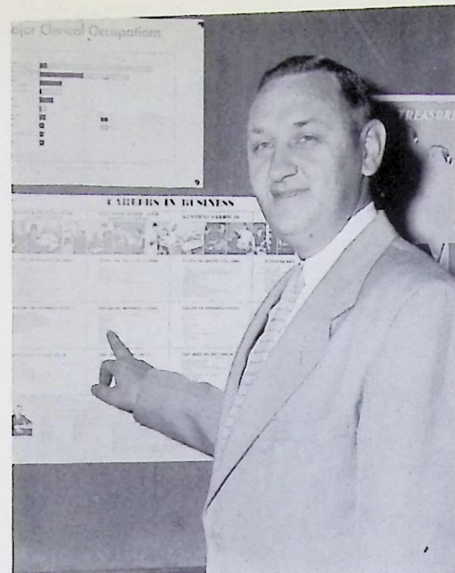

*Sturgis R. Carbin*



*Patricia Gugovich*

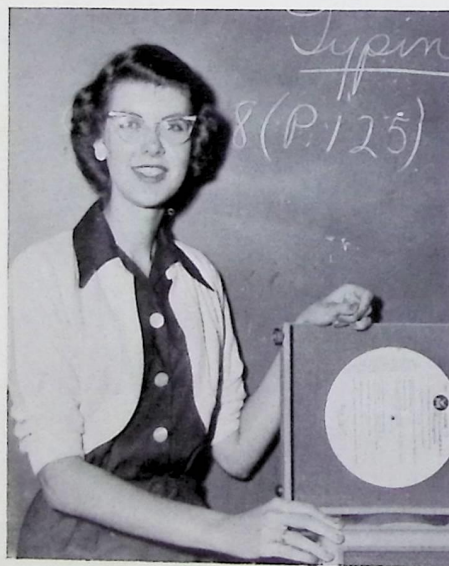

*Ann Kassing*



*Margaret W. Gibbs*



*Chas. M. Lockard*



*George J. Aretner*



*Milfred C. Hanson*

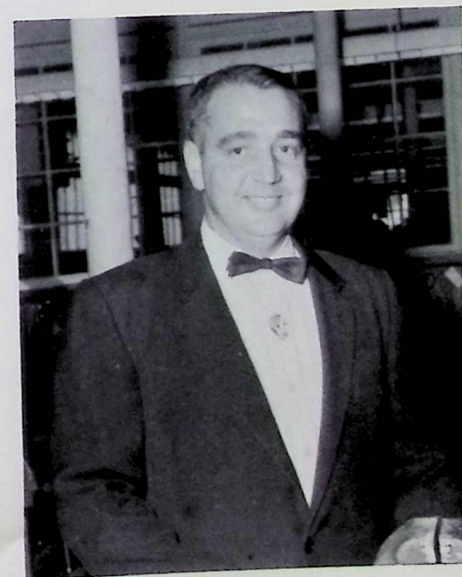

*R. Edw. Newman*





Sturgis R. Carbin



Patricia Jugovich



in Kassing



Margaret W. Gibbs

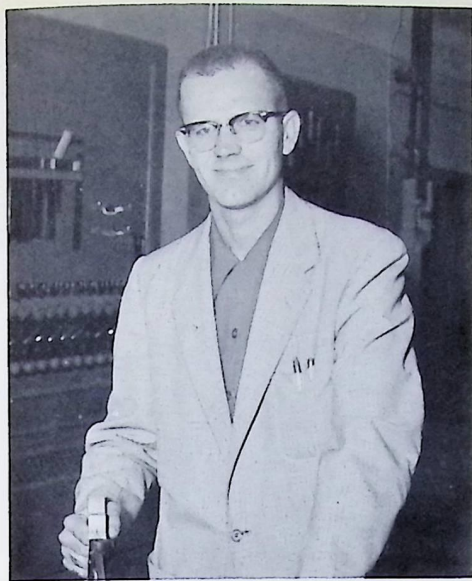

Chas. M. Lockard



George J. Grener



Wilfred F. Fries



Milford C. Hanson

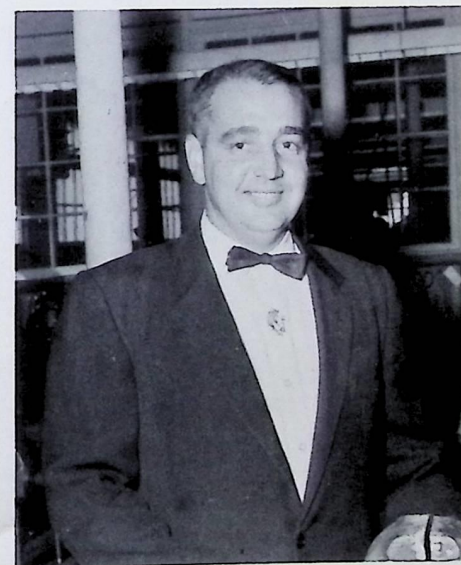

R. Edw. Heerman



Donald S. Bailis

F  
A  
C  
U  
L  
T  
Y

F  
A  
C  
U  
L  
T  
Y



*Marjorie Danforth*



*Hazel J. Farmer*



*Stan Foster*

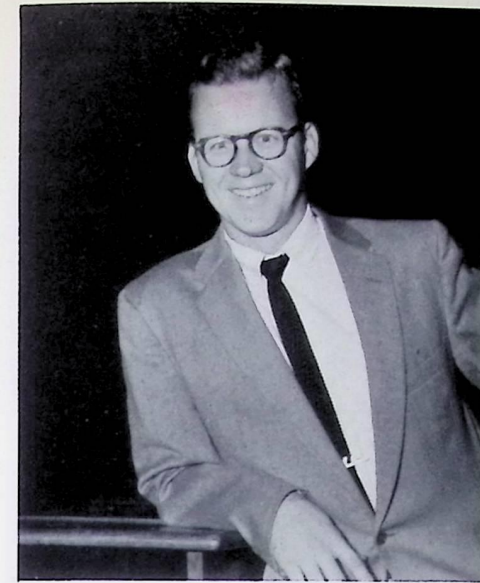

*Carl H. Custer*

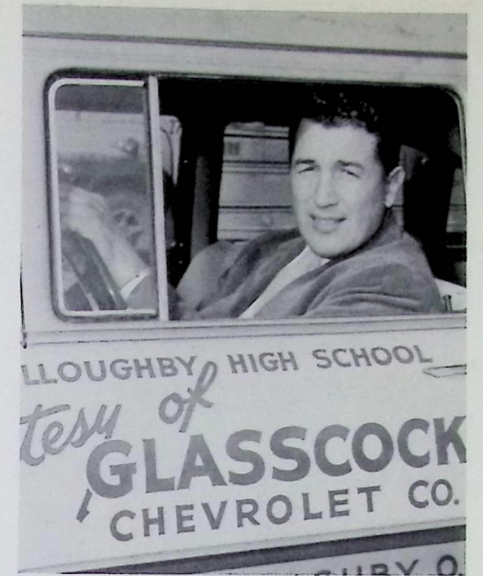

*R. R. Schminck*

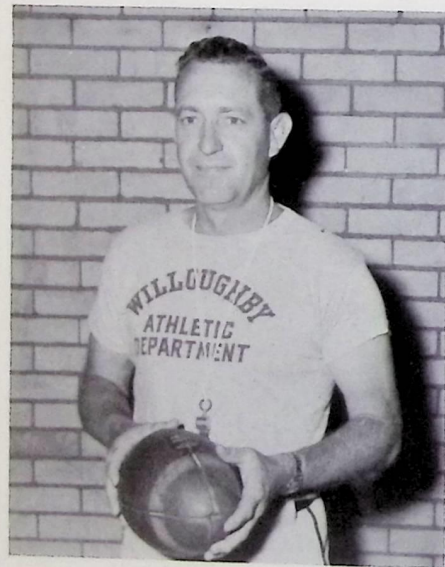

*Harry Winters*



*Charles W. Ruddick*



*M. W. Everson*

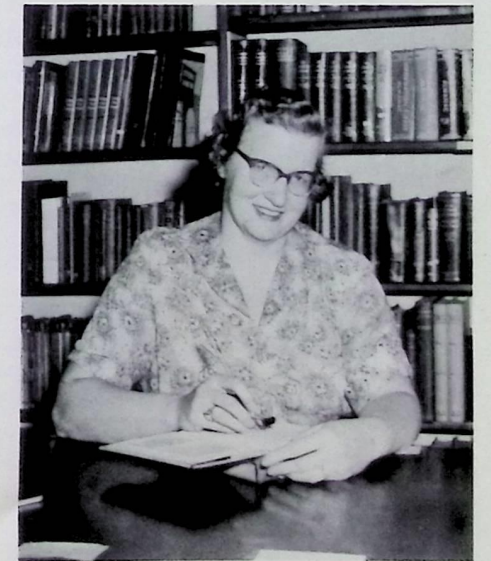

*Eleanor Heusel*



*Hazel J. Furmer*



*Stan Foster*



*Charles W. Ruddick*



*M.W. Everson*



*Carl H. Custer*



*R. R. Schmitz*



*Jack Huth*



*Eleanore Heusel*

F  
A  
C  
U  
L  
T  
Y

F  
A  
C  
U  
L  
T  
Y



# FEATURING

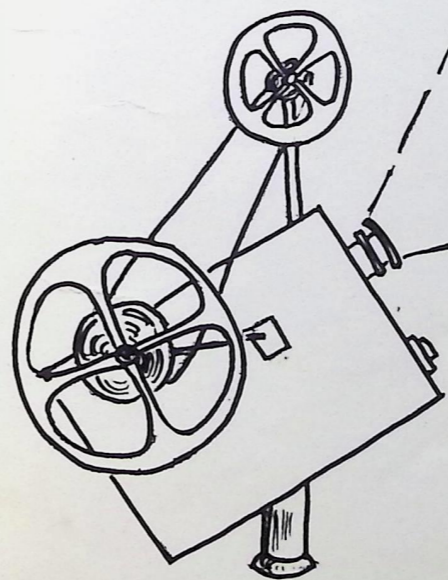

# SEN



# FEATURING

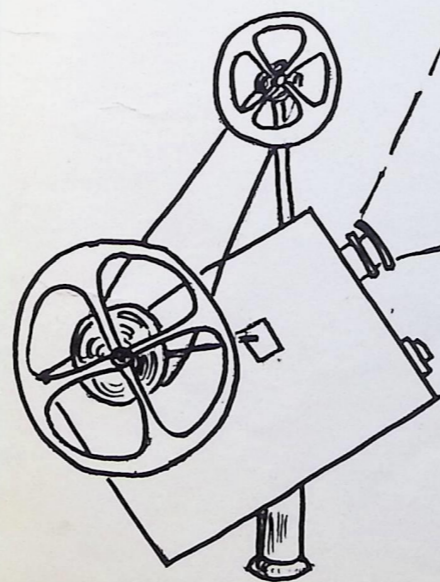

# SENIORS

# CAMPUS FLASHES



VOICE OF DEMOCRACY  
DISTRICT WINNER  
GAIL YORK



BOYS' STATE  
JIM RAUKER, DICK NEEDHAM

GIRLS' STATE  
CYNTHIA BOUTON, JUDY ROGERS



NATIONAL MERIT SCHOLARSHIP  
HONORABLE MENTION  
Seated: L. Goldrick, L. Donovan  
Standing: B. McLean, D. Pelz.

BAUSCH LOMB SCIENCE AWARD WINNER-----DAVE PELZ

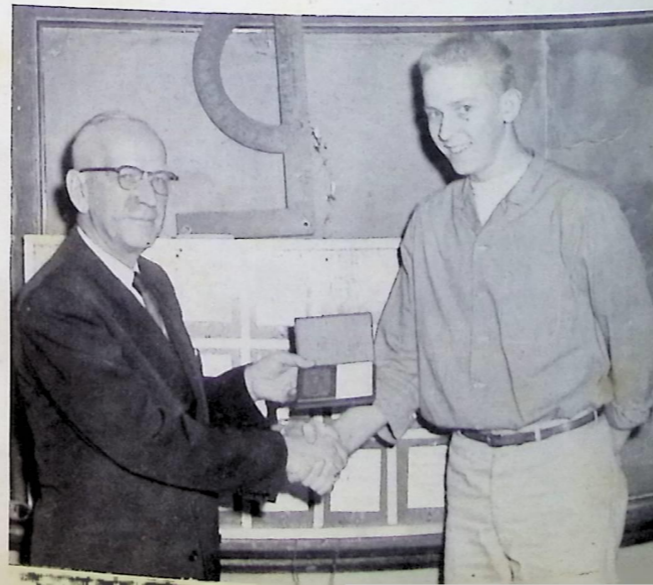

# SENIOR OFFICERS AND COUNCIL

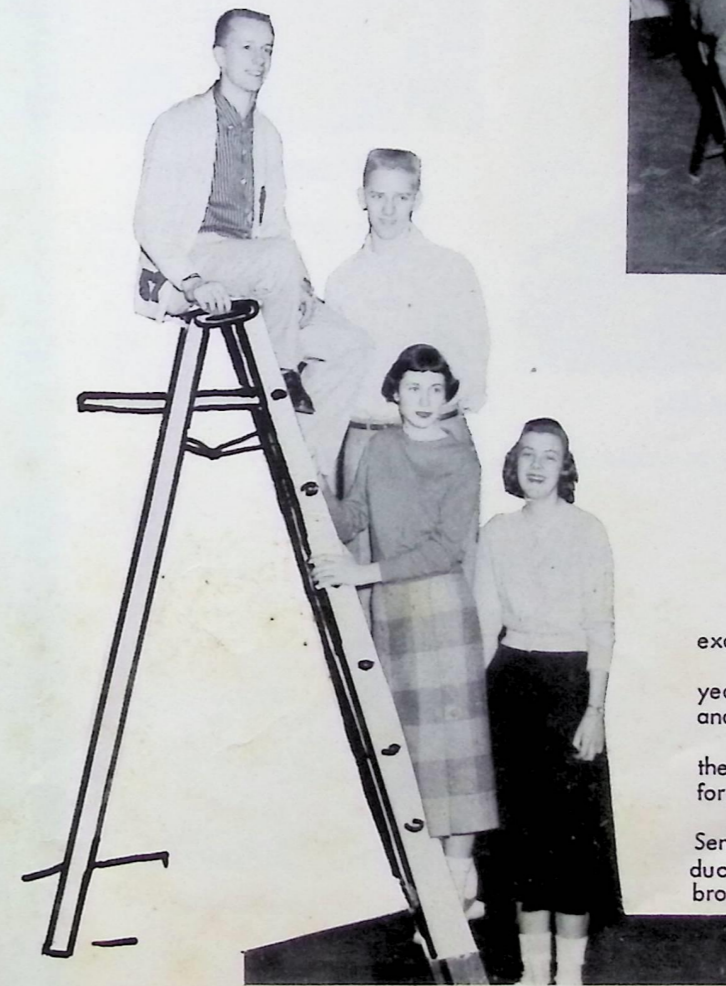

Dick Needham, Pres.; Dave Pelz, V.-P.; Nicki Lippens, Sec.; Sally Farran, Treas.



Senior Council: D. Miller, R. Lang, S. Hengst, N. M.

# CLASS OF

The class of 1957 collectively has many memories of past exciting and enjoyable.

From the time we were tenth graders enjoying the unforgetable year and the wonderful night of the senior prom, our lives have been filled with many memorable events.

What member of the graduating class could ever forget the "Family Tree," the sock hop, the beany sale, and the col for the prom?

Then came our senior year which was ushered in by the Senior night at the basketball game and the dance afterward. We have raised funds for the loveliest night of the year, the senior prom, which brought our senior year to a close.



VOICE OF DEMOCRACY  
DISTRICT WINNER  
GAIL YORK



GIRLS' STATE  
CYNTHIA BOUTON, JUDY ROGERS



NATIONAL MERIT SCHOLARSHIP  
HONORABLE MENTION  
Seated: L. Goldrick, L. Donovan  
Standing: B. McLean, D. Pelz.

BAUSCH LOMB SCIENCE AWARD WINNER-----DAVÉ PELZ

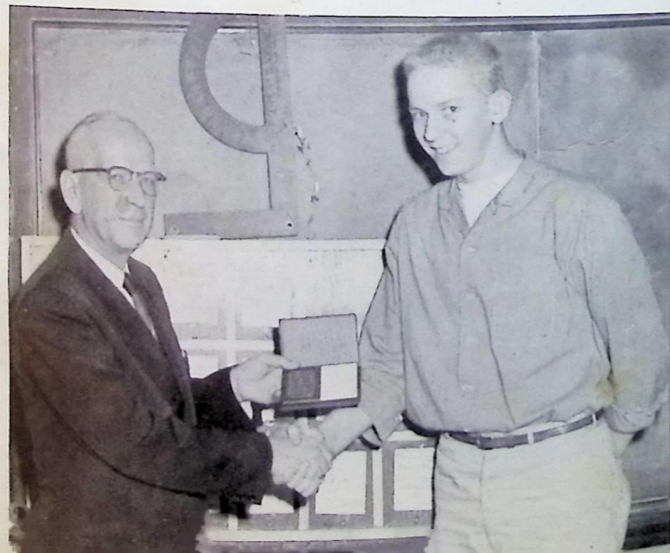

## SENIOR OFFICERS AND COUNCIL

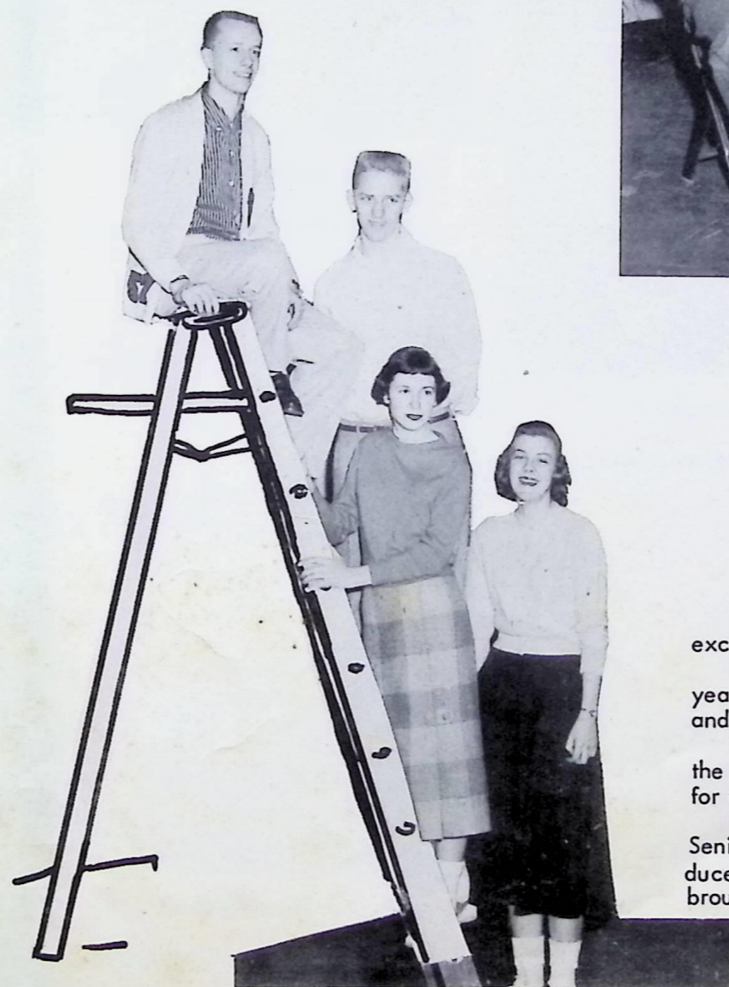

Dick Needham, Pres.; Dave Pelz, V.-P.; Nicki Lippens, Sec.; Sally Farran, Treas.



Senior Council: D. Miller, R. Lang, S. Hengst, N. Dey, A. Shaw, B. Schultz, J. Dixon.

## CLASS OF 1957

The class of 1957 collectively has many memories of past experiences that have made our years at WHS exciting and enjoyable.

From the time we were tenth graders enjoying the unforgettable freshman-sophomore dance to our senior year and the wonderful night of the senior prom, our lives here in school have been filled with gratifying and memorable events.

What member of the graduating class could ever forget the junior year with the junior play, "We Shook the Family Tree," the sock hop, the beany sale, and the collection of tax stamps to raise the needed revenue for the prom?

Then came our senior year which was ushered in by the Senior Street Strut and the Senior Class Play. Senior night at the basketball game and the dance afterward, and the senior skating party helped to produce funds for the loveliest night of the year, the senior prom. A wonderful meal at the senior banquet brought our senior year to a close.



JIM ACKROYD

He's really a riot when not being quiet.



JEAN ALEXANDER

She brightens the day with her happy way.



ANN ALLEN

A pleasant maid with a pleasant smile.



DON ALLEN

Kills time but never works it to death.



GAIL ANTONIN

Better to have than to wish.



AUDREY BAILEY

She neglects not the gift that is in her.

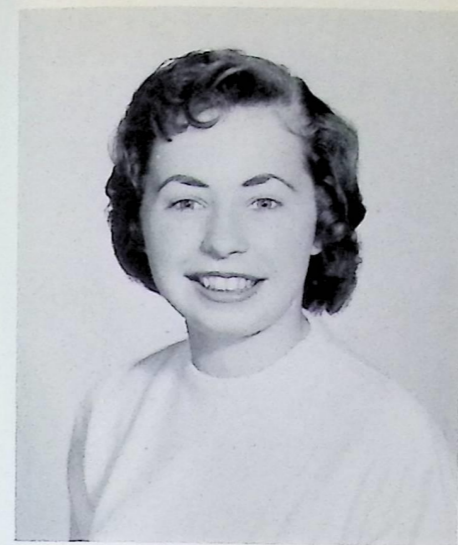

DIANNE BARNARD

Extreme it's true, but extremely nice, too.



MARY BAKER

Hitch your wagon to a star.



GLENDA BELL

Greatness is not determined by size.

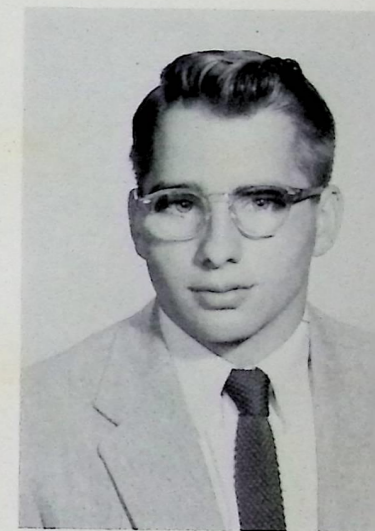

GLEN BELL

Short, sharp, such a gentlem





ANN ALLEN

A pleasant maid with a pleasant smile.



DON ALLEN

Kills time but never works it to death.



GAIL ANTONIN

Better to have than to wish.



AUDREY BAILEY

She neglects not the gift that is in her.



DIANNE BARNARD

Extreme it's true, but extremely nice, too.



MARY BAKER

Hitch your wagon to a star.



GLENDA BELL

Greatness is not determined by size.



GLEN BELL

Short, sharp, such a gentleman.

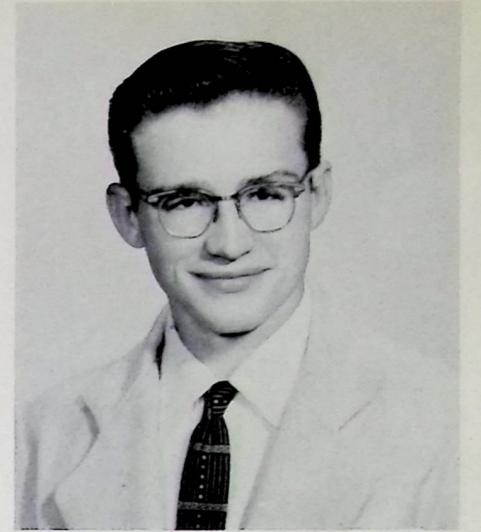

RON BEYERLE

He'll win with a friendly grin.



JOHANNA BERG

Her ways are ways of pleasantness.



BROMLEY BILTON

All good things come to those who wait--I'm waiting.



MYRNA BITTNER

Charm is nonsense and nonsense is charm.



CAROLYN BLAZY

Dance, Ballerina, Dance.



ALBERTA BOHNERT

A cheerful friend is like a sunny day.



CYNTHIA BOUTON

"There's a bass in the bathtub!"



CAROLYN BOMGARDNER

Tops among red-heads.

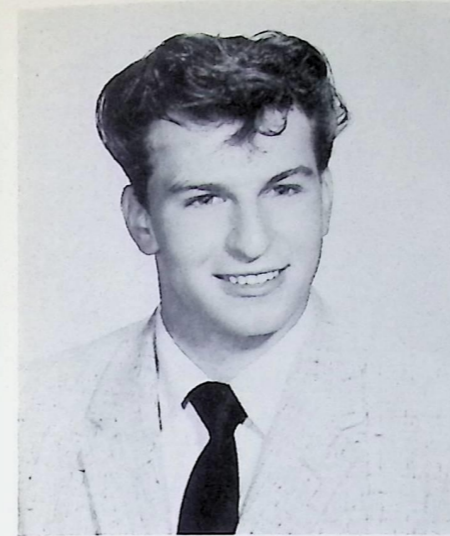

BOB BRENESTUHL

"Come on all you cool cats!"



PATTY BOYKIN

A lump from heaven with a dash of the devil.



RAY BREZIC

Deserving all, demanding nothing.

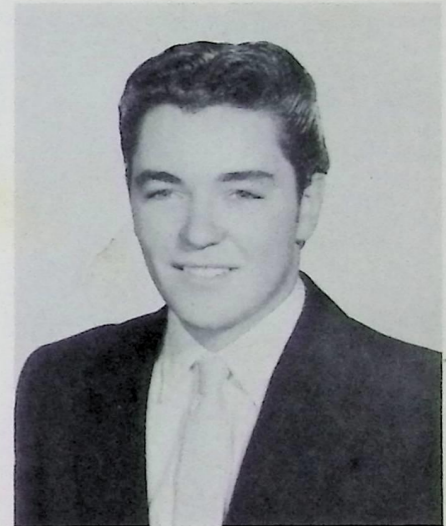

JACK BRIGGS

Jack of all trades.



ALBERTA BOHNERT

A cheerful friend is like a sunny day.



CYNTHIA BOUTON

"There's a bass in the bathtub!"

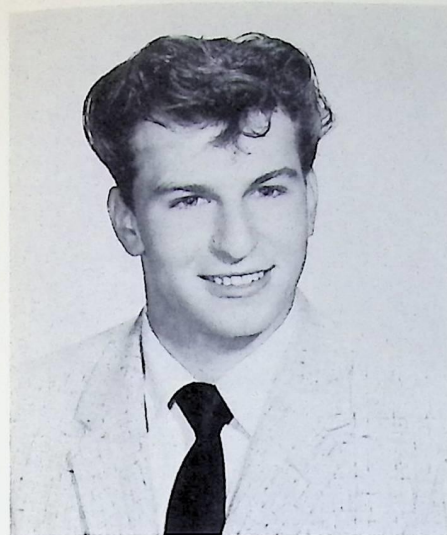

BOB BRENENSTUHL

"Come on all you cool cats!"

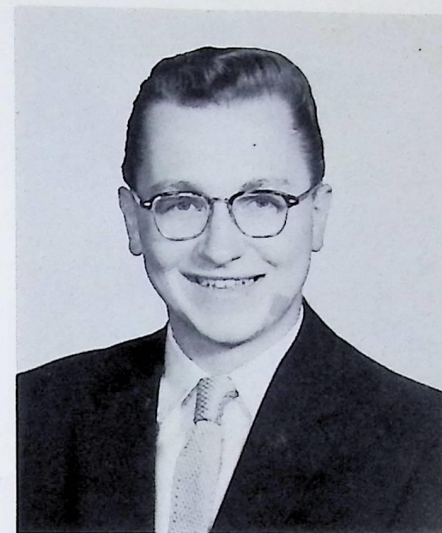

RAY BREZIC

Deserving all, demanding nothing.

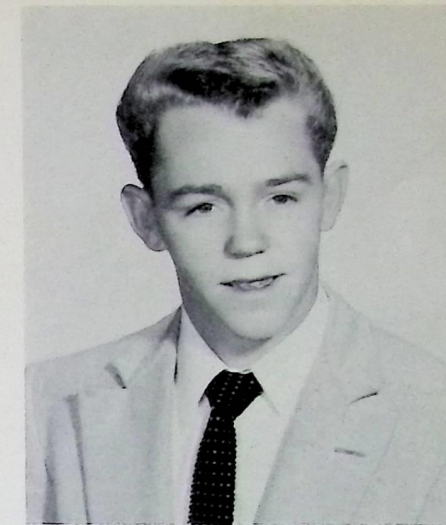

EDGAR BROTT

Men of a few words are the best of men.



JACK BRIGGS

Jack of all trades.



JUDITH BROD

A cheerful little earful.



CAROLYN BOMGARDNER

Tops among red-heads.



PATTY BOYKIN

A lump from heaven with a dash of the devil.

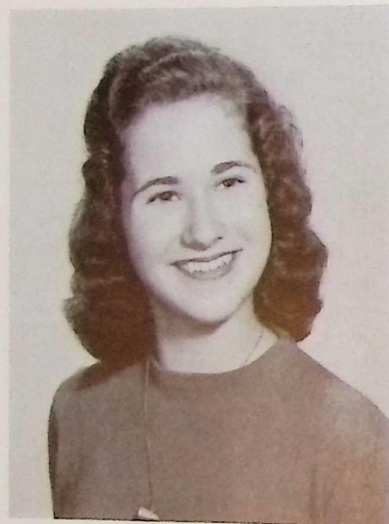

CAROLYN BLAZY

Dance, Ballerina, Dance.



JANE BUCHNER

She found a way to stay cheerful and gay.



LANCE BUHL

Nothing great was ever achieved without enthusiasm.



GORDON CAUDILL

Work isn't work if you like it.



LOUISE CECELIC

A smile, a dimple, sweet and simple.



GILBERT CHASE

One today is worth two tomorrows.



ELAINE CHESNES

An engaging little Miss.



MARIE CIULLA

The sweetest essences are always confined in the smallest glasses.



FLORIS CHISHOLM

Good humor is the health of a soul.



PATTY CLARKE

Her sunny locks hang on her temples like a golden fleece.



BERNADINE COLAGROSS

Silent and shy is this gal.



GORDON CAUDILL

Work isn't work if you like it.



LOUISE CECELIC

A smile, a dimple, sweet and simple.



GILBERT CHASE

One today is worth two tomorrows.



ELAINE CHESNES

An engaging little Miss.



MARIE CIULLA

The sweetest essences are always confined in the smallest glasses.



FLORIS CHISHOLM

Good humor is the health of a soul.



PATTY CLARKE

Her sunny locks hang on her temples like a golden fleece.



BERNADINE COLAGROSS

Silent and shy is this gal.



RICHARD COX

I try all things, I achieve what I can.



CAROL SUE CORBETT

A good word finds a good spot.

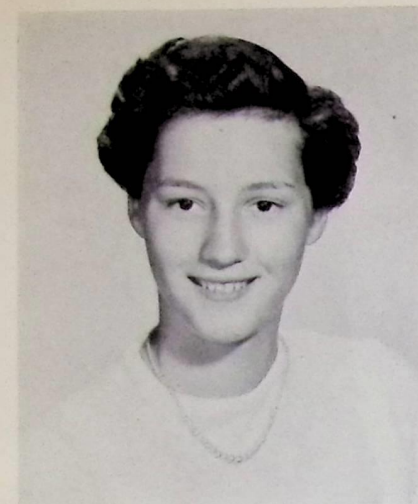

BETSY CREGO

She measures life with honesty and diligence.



RICHARD DENNIS

Sparing with words, free with smiles.

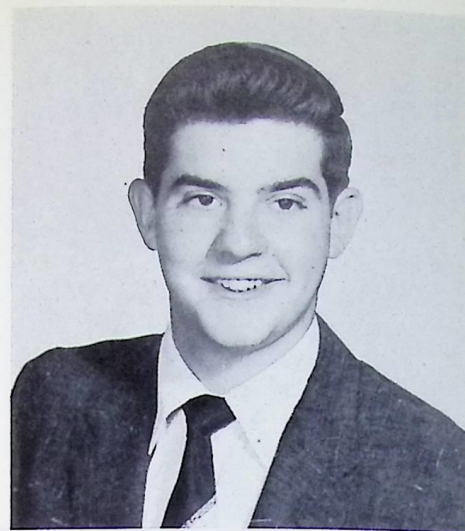

RONALD DESTRO

The world's all right, it's the people in it.

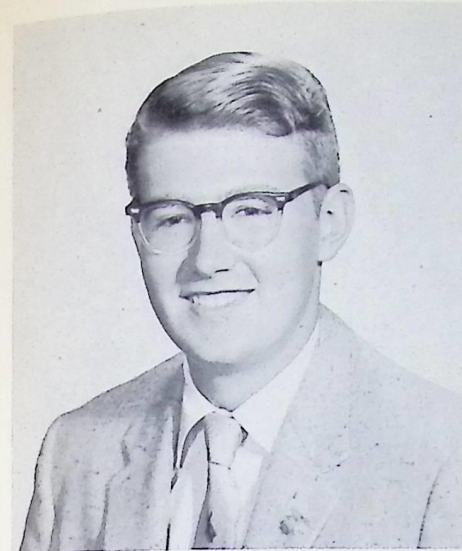

HAROLD DIETZ

"Seventy-nine years in a sandtrap!"



JIM DIXON

It's the custom that wit lies in obscurity, but he doesn't follow custom!



GAYNOL CROCKER

Bubbling with pep.

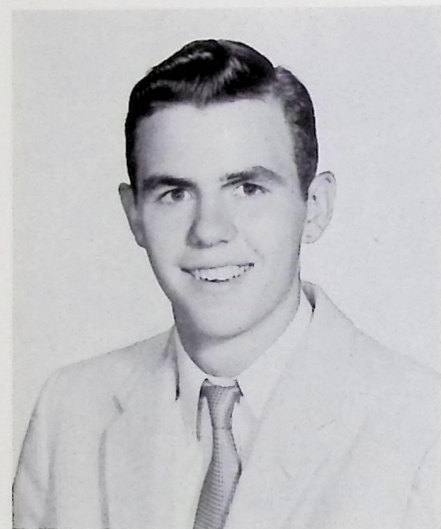

ELMER CROSIER

I'm saving my energy for my old age.



NORINE DEY

She never skips over the fine details.



BARBARA DICKSON

Ever gay, ever glad, ever good, never bad.



VIVIAN DODDS

Bright and gay in a winning way.

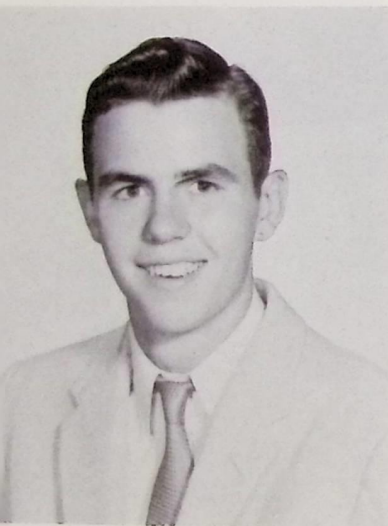

ELMER CROSIER

m saving my energy for my old age.

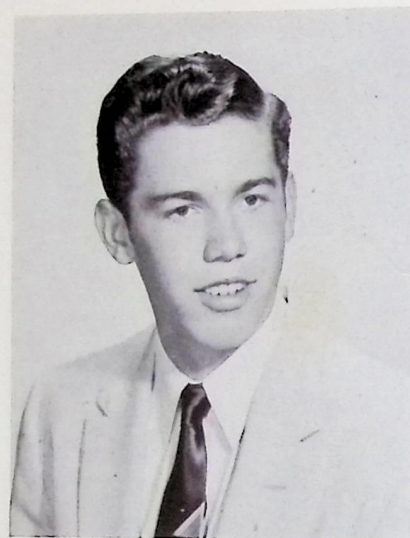

RICHARD DENNIS

Sparing with words, free with smiles.

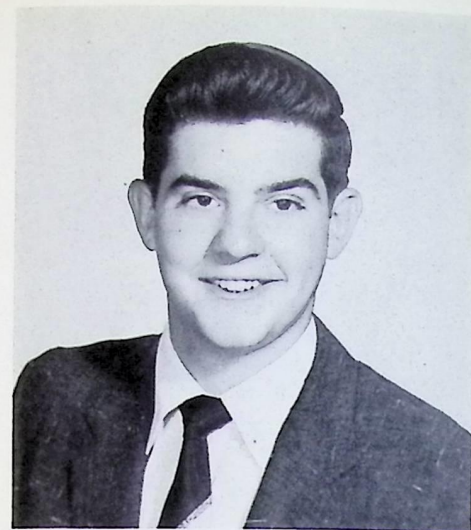

RONALD DESTRO

The world's all right, it's the people in it.



NORINE DEY

She never skips over the fine details.



HAROLD DIETZ

"Seventy-nine years in a sandtrap!"



BARBARA DICKSON

Ever gay, ever glad, ever good, never bad.



JIM DIXON

It's the custom that wit lies in obscurity, but he doesn't follow custom!



MARGARET DUCSAY

She strikes a happy note.



VIVIAN DODDS

Bright and gay in a winning way.



LINDA DONOVAN

It's a woman's hand that leads the band.



IDA EGLESTON

Silence is a true friend who never betrays.

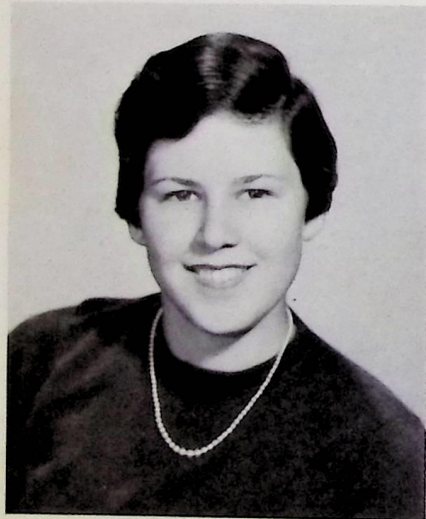

SUSAN ESTES

Sweet Sue, full of laughter, full of fun.

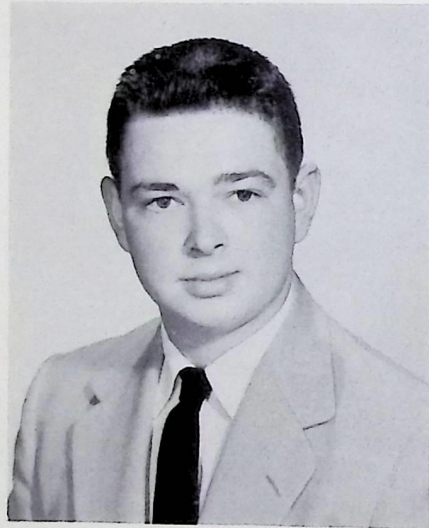

MIKE EVANS

Do the Marines really know what they're getting?

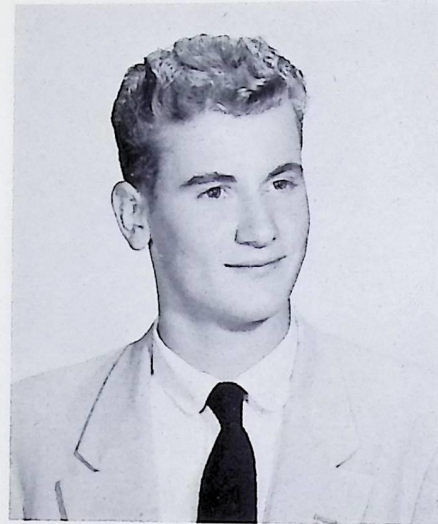

DON FAIRBANKS

A quiet soul is he--sometimes.



RODERICK FAULK

Wise from the top of the head up.



SALLY FARRAN

Serene I fold my hands and wait.



EVERETT FERTIG

Sooooo big.



SALLY FEDOR

A wonderful girl with a wonderful sense of humor.

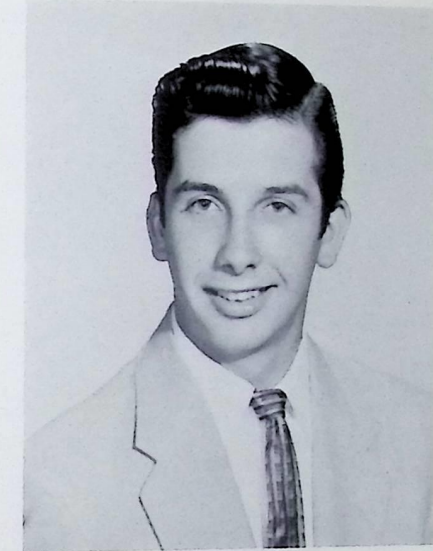

GARY FORSBERG

He travels through a field of fun.



AUDREY FOUTZ

A smile shining with personality.





MIKE EVANS

Do the Marines really know what they're getting?

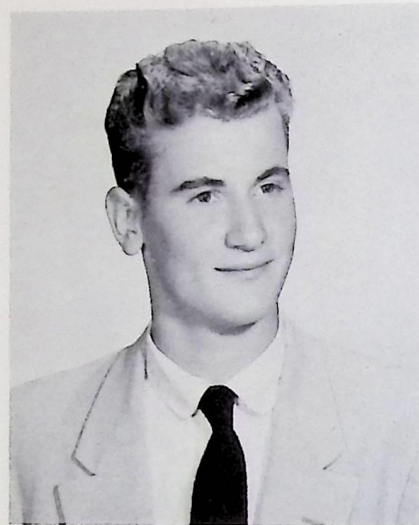

DON FAIRBANKS

A quiet soul is he--sometimes.



RODERICK FAULK

Wise from the top of the head up.



SALLY FARRAN

Serene I fold my hands and wait.



EVERETT FERTIG

Sooooo big.



SALLY FEDOR

A wonderful girl with a wonderful sense of humor.

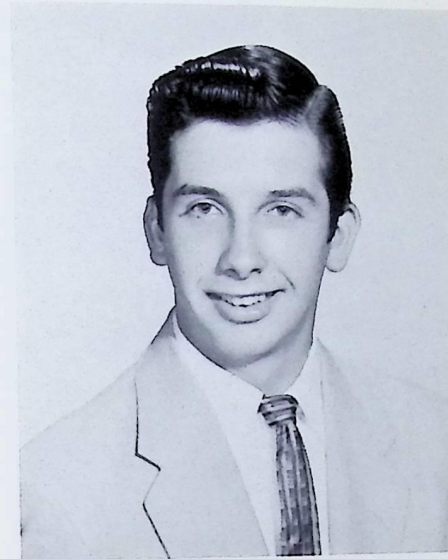

GARY FORSBERG

He travels through a field of fun.



AUDREY FOUTZ

A smile shining with personality.



KITTY GARRICK

A constant source of surprises.



PAT FRAZIER

I count only the hours that are bright.



BARBARA GAU

Here's friendship filled with fun.

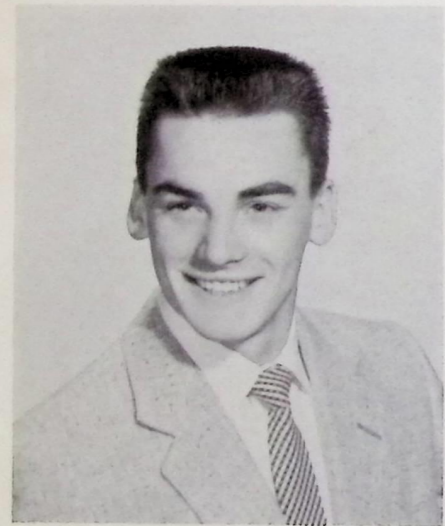

TOM GIELING

A smile that could eat a banana side-ways.



LARRY GOLDRICK

Though he's quiet and shy, he's really quite a guy.

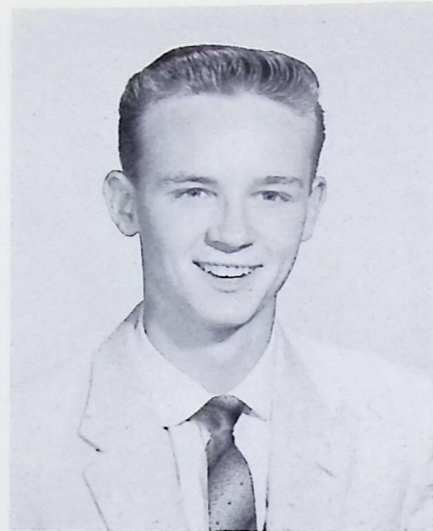

BOB GONGAS

The exception to the rule.

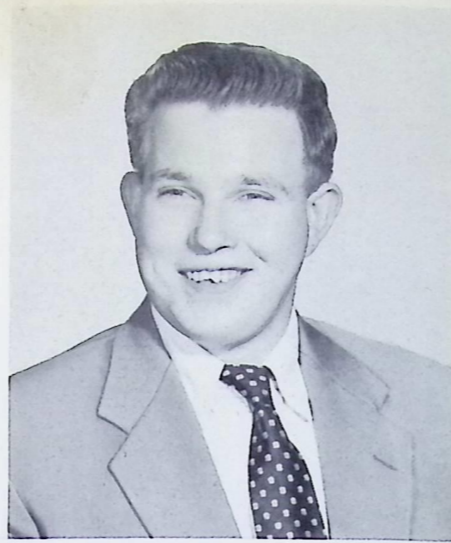

KARL GROSS

He gives his thought no voice.



PAT HADLEY

One's eyes are what one is.



ROBERTA HALL

Blondes prefer gentlemen.



MARJORIE HARRIS

She takes a place on the road to happiness.



BARBARA HALABURDA

Effervescent laughter!

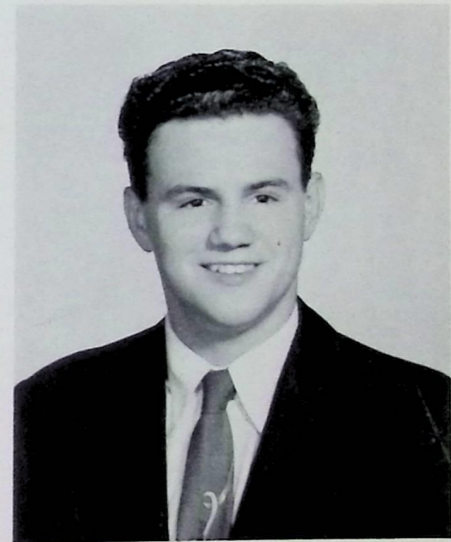

RICHARD HARTMAN

Easy going, easy knowing.

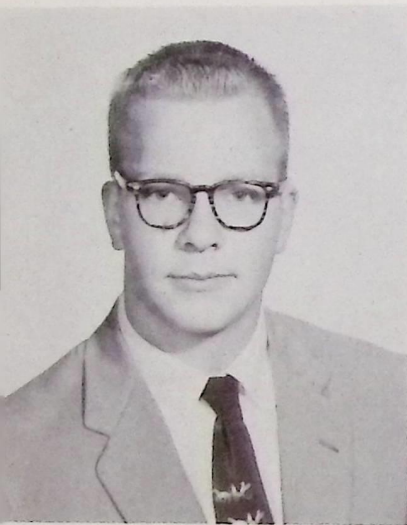

LARRY GOLDRICK

Though he's quiet and shy, he's really quite a guy.

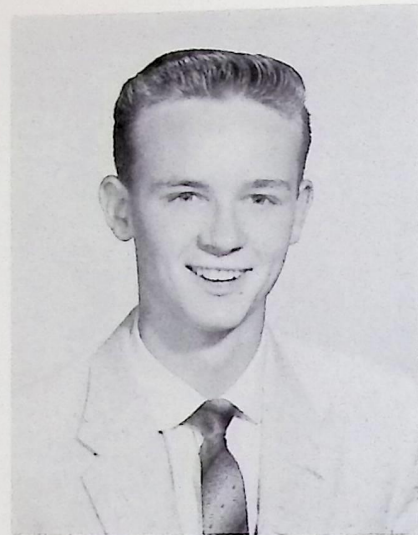

BOB GONGAS

The exception to the rule.



PAT HADLEY

One's eyes are what one is.

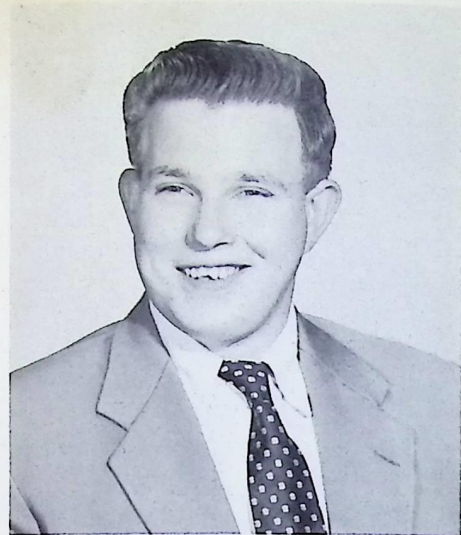

KARL GROSS

He gives his thought no voice.



BARBARA HALABURDA

Effervescent laughter!



ROBERTA HALL

Blondes prefer gentlemen.



MARJORIE HARRIS

She takes a place on the road to happiness.



RICHARD HARTMAN

Easy going, easy knowing.



BUDDY HAUSER

Although he says little, he knows much.

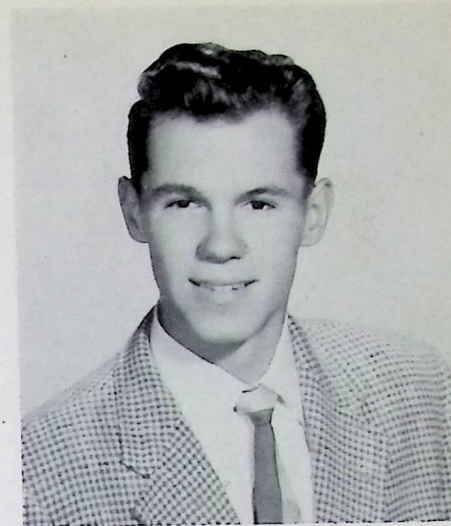

AL HELTMAN

The drummer's drummer.

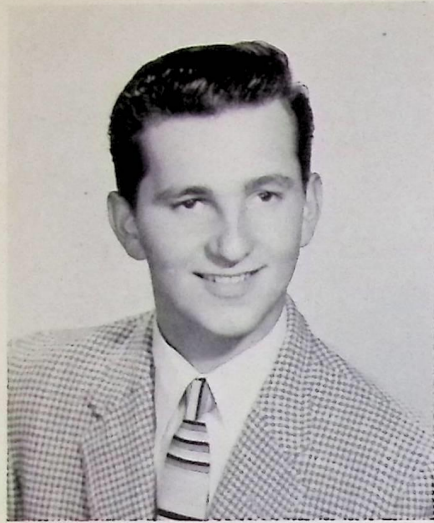

JIM HELTMAN  
Knowledge is power.



HAROLD HENDERSHOT  
A friend always, a sport all through.



SUZANNE HENGST  
She likes redheads!



LAURA LEE HEROLD  
She "HEROLDS" the good things in life.

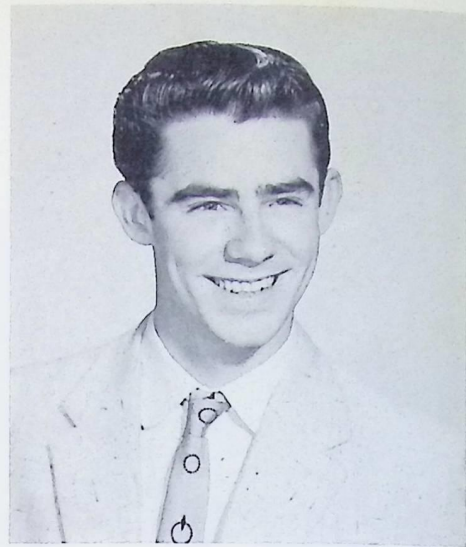

RONALD HERRICK  
Got a hot rod Ford!

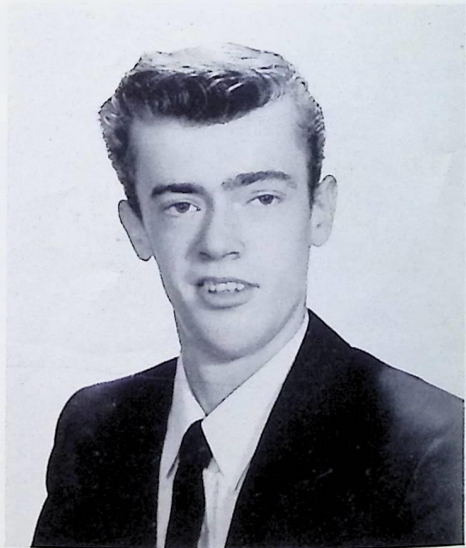

LARRY HETH  
There's a time for all things.

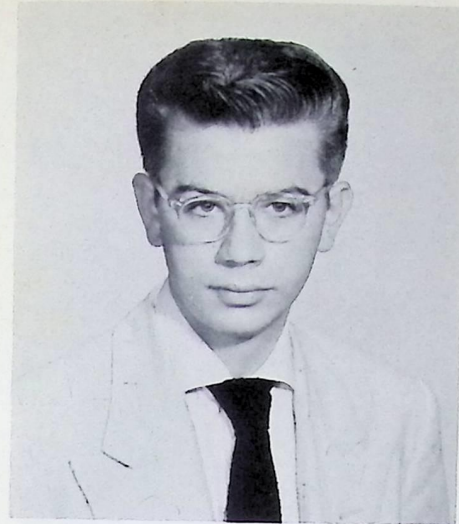

FRED HOFFMAN  
When I sleep, I think not.



PAT HIGGENBOTHAM  
Gone but not forgotten.

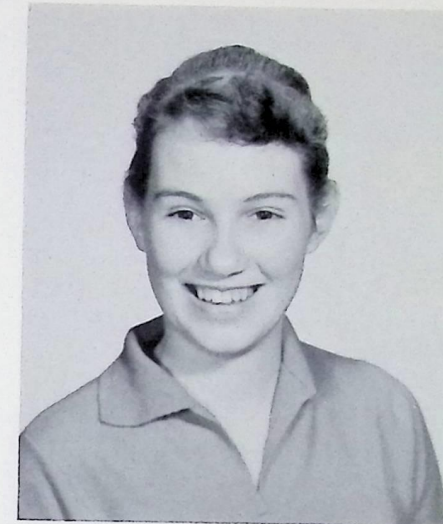

DONNA HOGG  
Little friends may prove great friends.



BOB HOUSTON  
Each man is justified in his own individuality.



SUZANNE HENGST  
She likes redheads!



LAURA LEE HEROLD  
She "HEROLDS" the good things in life.



LARRY HETH  
There's a time for all things.



RONALD HERRICK  
Got a hot rod Ford!



PAT HIGGENBOTHAM  
Gone but not forgotten.

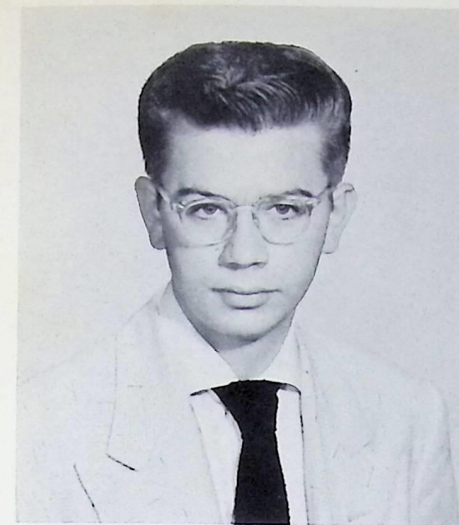

FRED HOFFMAN  
When I sleep, I think not.



DONNA HOGG  
Little friends may prove great friends.



BOB HOUSTON  
Each man is justified in his own individuality.

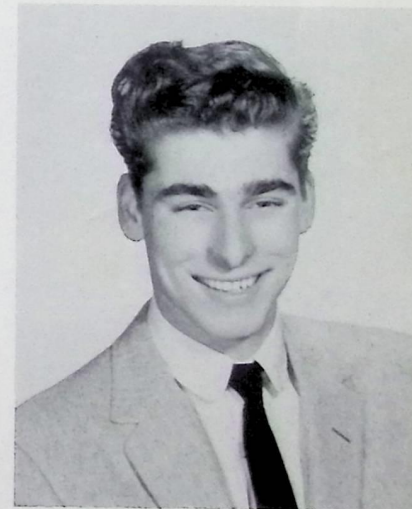

BOB HOVANCE  
Effort is his middle name.



JEAN HULL  
Modesty sets off sprightly wit.



ARLENE HULT

In her quietness she'll be heard.



ALICE HUSTON

As lovely as an angel.



CATHERINE JACKSON

From a spark may burst a mighty flame.

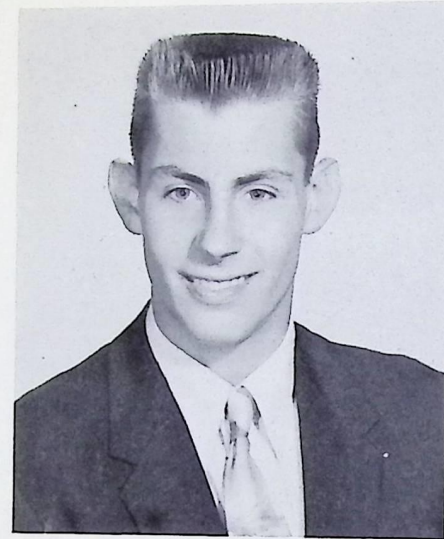

GARY JARMUSCH

There's no fun in winning a thing unless you play for it.

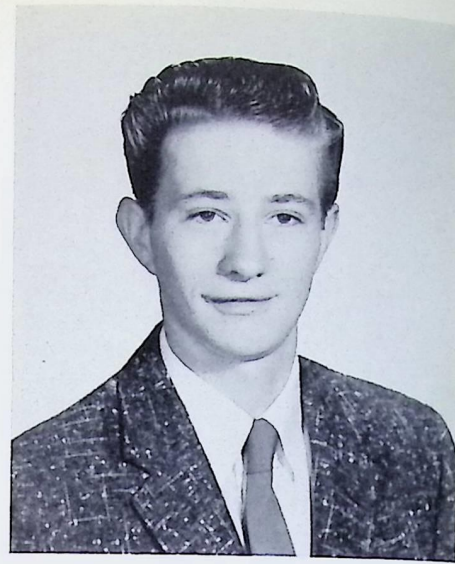

BILL JAZBEC

He'll win with a friendly grin.



NANCY JUCKS

Sweet and lovely.

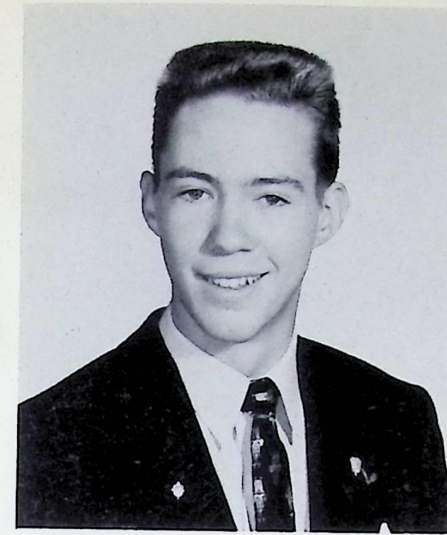

DAN KENNEDY

The mildest manner, the gentlest heart.

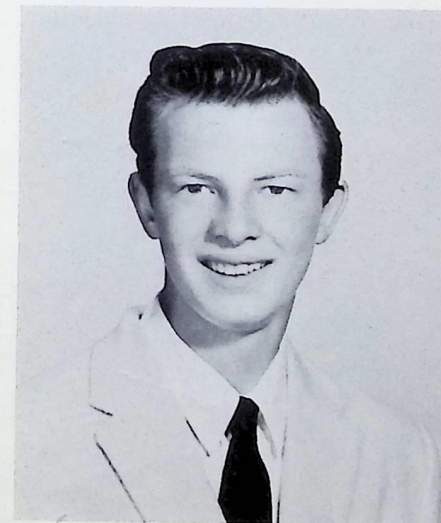

ERNEST KELLNER

Each man to his own desires.

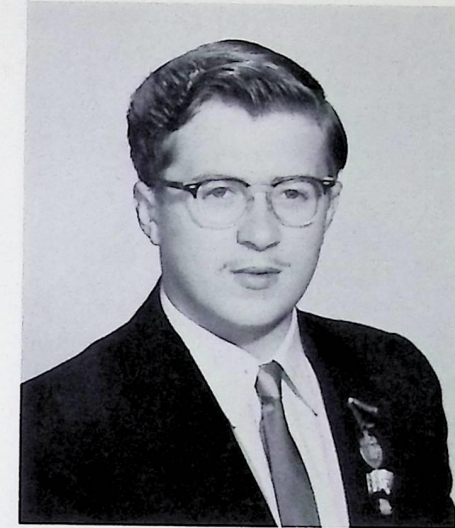

IVAN KENYON

Drive thy business; let it not drive thee.



WILLIAM KLEIN

He is just the quiet kind whose nature never fails.



CATHERINE JACKSON

From a spark may burst a mighty flame.

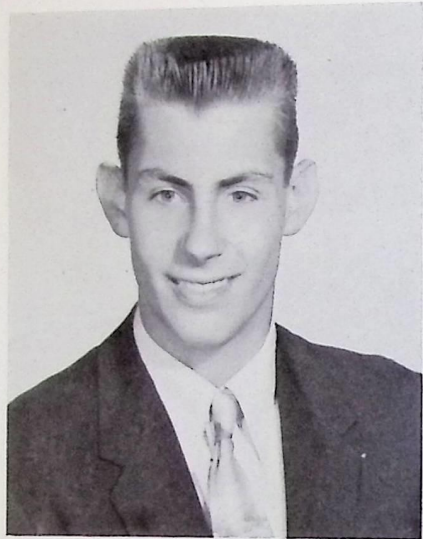

GARY JARMUSCH

There's no fun in winning a thing unless you play for it.



BILL JAZBEC

He'll win with a friendly grin.



NANCY JUCKS

Sweet and lovely.

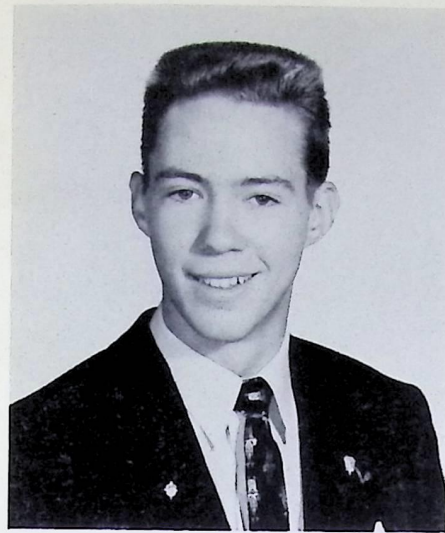

DAN KENNEDY

The mildest manner, the gentlest heart.

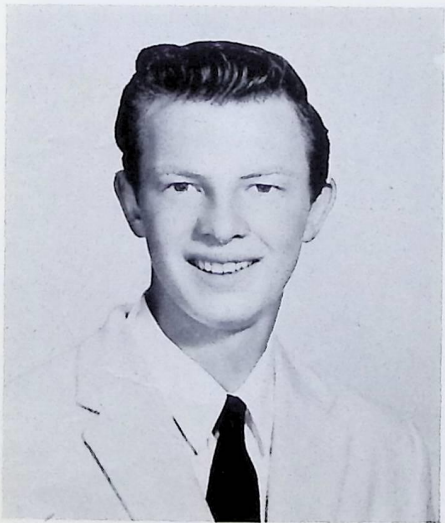

ERNEST KELLNER

Each man to his own desires.



IVAN KENYON

Drive thy business; let it not drive thee.

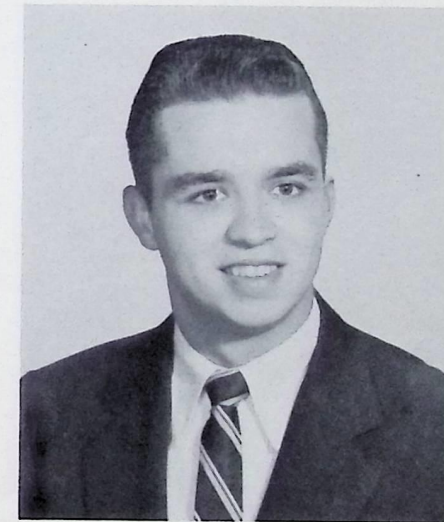

WILLIAM KLEIN

He is just the quiet kind whose nature never fails.



LEE KNAPTON

Sincerity triumphs over all.



ART KLESS

I thought twice before I spoke and found the subject had changed.



SANTHA KOHLER

A sweet shy girl is she.

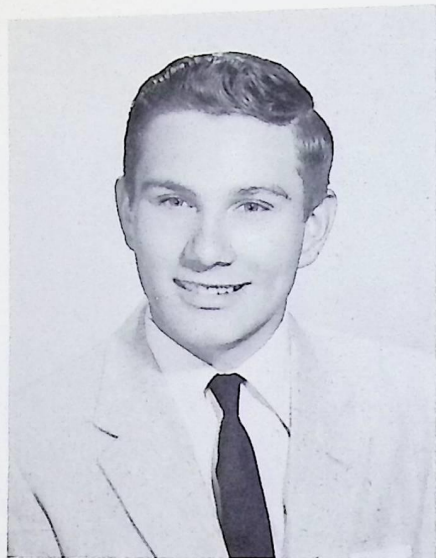

SAM LAMBO

Where there's a will, there's a way.



SONJA LAMOS

A diamond forever.



NORMA LAGEN

To one who waits, a moment seems a year.



JERRY LATTIMORE

Power dwells in his cheerfulness.



MARY ANN KRAKER

Youth, beauty, graceful action seldom fail.



EDDIE KUHAR

Happy and gay in a carefree way.

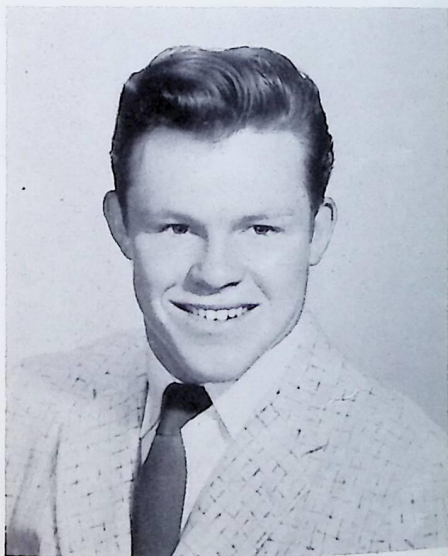

RONNIE LANG

A redhead up to par.



ALICIA LANN

In her quietness she has charm.



NANCY LEONELLO

Tiny but loaded with energy.



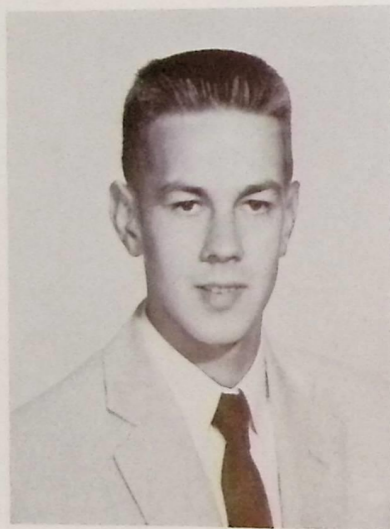

EDDIE KUHAR

Happy and gay in a carefree way.



SAM LAMBO

Where there's a will, there's a way.



RONNIE LANG

A redhead up to par.



SONJA LAMOS

A diamond forever.



NORMA LARGEN

To one who waits, a moment seems a year.



ALICIA LANN

In her quietness she has charm.



JERRY LATTIMORE

Power dwells in his cheerfulness.



NANCY LEONELLO

Tiny but loaded with energy.



MONIQUE LIPPENS

If silence were golden she'd be poor.



DENNIS LINO

His power lies in his thoughts.



ROBERTA LITWILER

She enjoys the pleasures she gives.

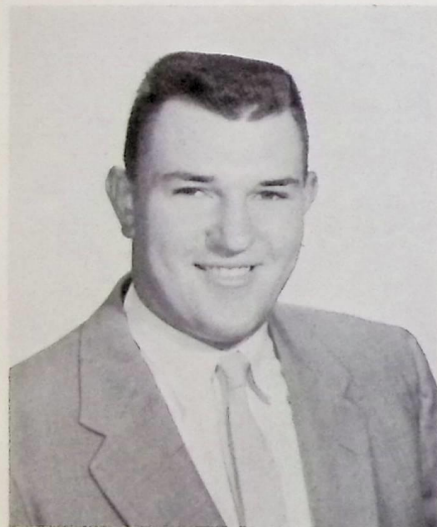

CHARLES LOACH

You can't keep a good man down.



PHYLLIS LOCKARD

It's quality rather than quantity.



KURT LOHMEYER

His humor is a fountain that never runs dry.



JOAN MALJARIK

Happiness awaits.



ARLENE MANCINI

Deserving of happiness.



JOHN MATZ

He sows good fellowship and reaps good friendship.



GARY MATOUSEK

People are funnier than anyone.



BOB McLEAN

Genius finds its own road.

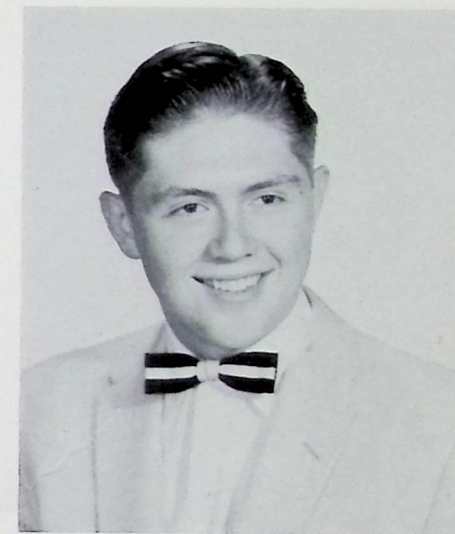

ARTHUR MELTON

Courtesy is the best policy.



PHYLLIS LOCKARD  
It's quality rather than quantity.



KURT LOHMEYER  
His humor is a fountain that never runs dry.



JOAN MALJARIK  
Happiness awaits.



ARLENE MANCINI  
Deserving of happiness.

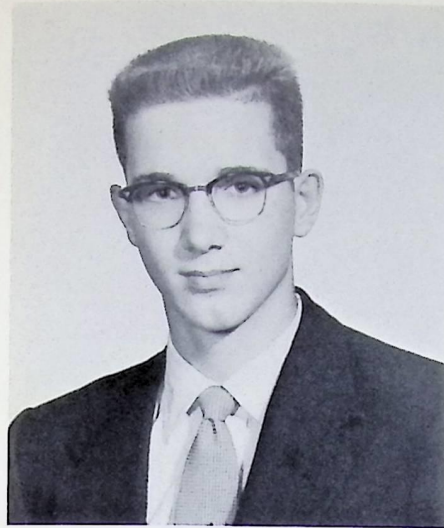

JOHN MATZ  
He sows good fellowship and reaps good friendship.

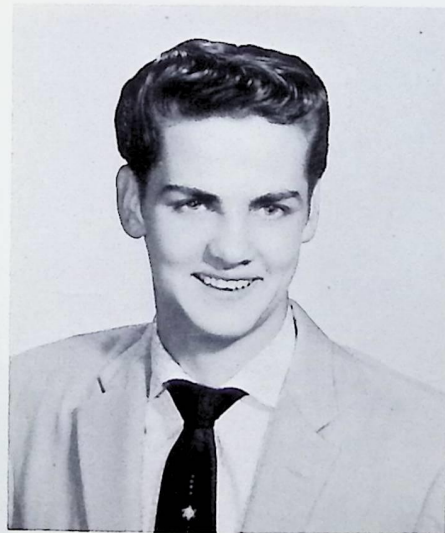

GARY MATOUSEK  
People are funnier than anyone.



BOB McLEAN  
Genius finds its own road.

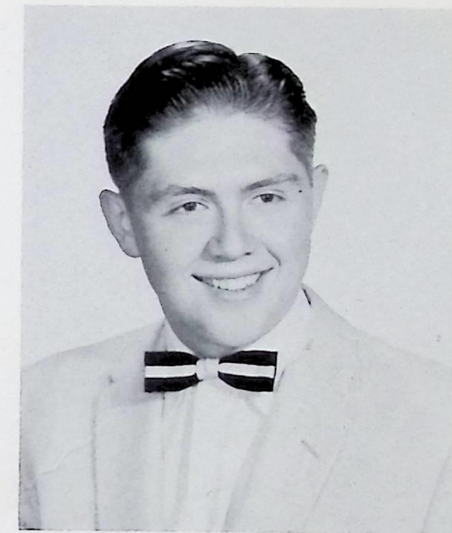

ARTHUR MELTON  
Courtesy is the best policy.



MARGIE MESTROVICH  
A model of charm and apparel perfection.



PHYLLIS MERICLE  
Friendship filled with fun.



BARBARA MIHALICK

Her friends are many, her worries few.



MAROLYNE MILLER

Life is a song.



JANICE MILLER

Fancy free and full of fun.



DICK MILLER

Dark and tall, nice to all.



JEROME MITCHELL

Easy going and easy knowing.



BETTY MITROVICH

Nothing is pleasant unless spiced with variety.



PEGGY MORENZ

Never a dull moment.



RAY MOMINEY

You're joking, you must be joking.

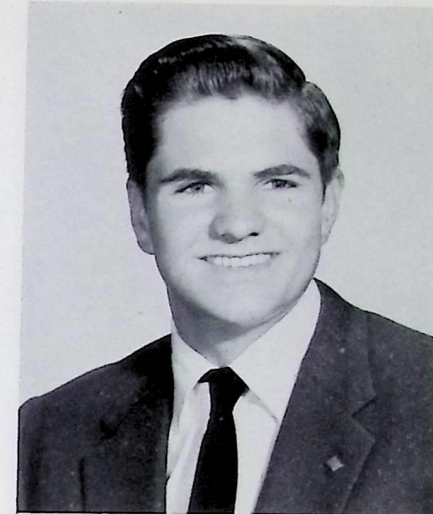

RONALD MORGAN

Beware I might do something startling yet.

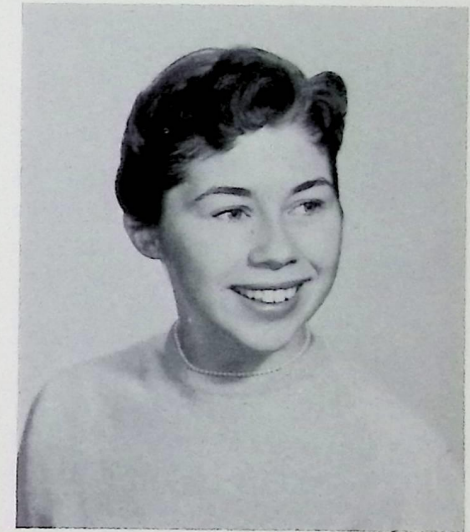

NANCY MORLOCK

Quiet, kind, and sweet, the kind you really like to meet.



MAROLYNE MILLER

Life is a song.

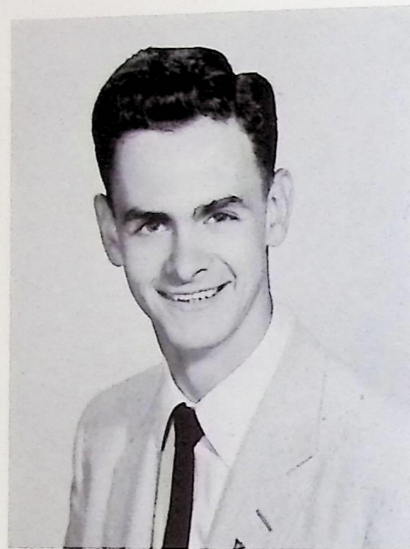

DICK MILLER

Dark and tall, nice to all.



JEROME MITCHELL

Easy going and easy knowing.



BETTY MITROVICH

Nothing is pleasant unless spiced with variety.



PEGGY MORENZ

Never a dull moment.

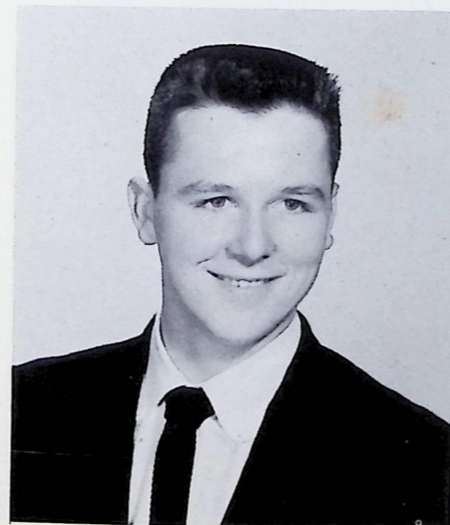

RAY MOMINEY

You're joking, you must be joking.

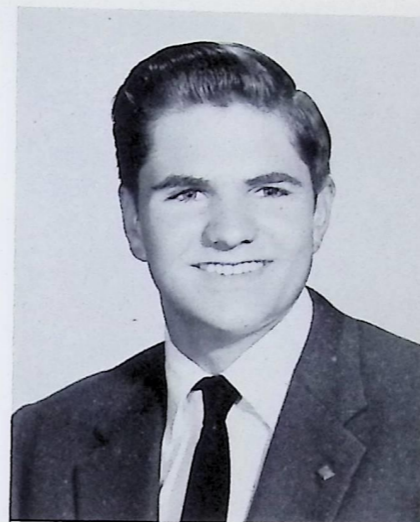

RONALD MORGAN

Beware I might do something startling yet.

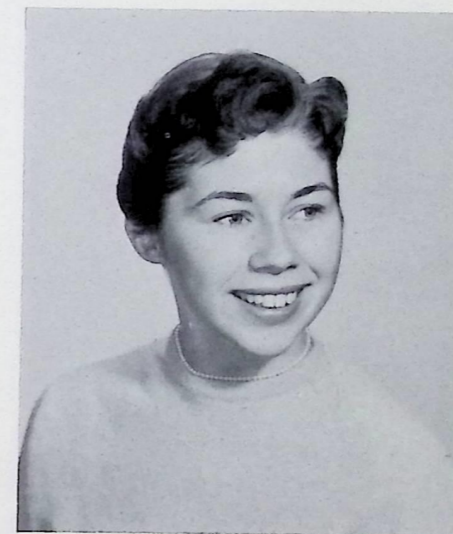

NANCY MORLOCK

Quiet, kind, and sweet, the kind you really like to meet.



ANITA MUCCINI

Some people think I'm quiet but I know different.

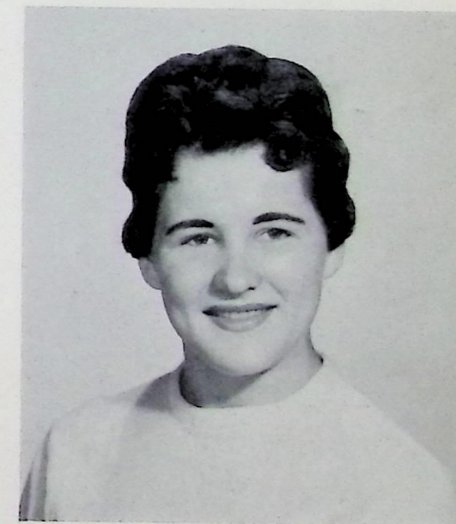

MARLENE MORROW

Strike up the band, third finger, left hand.

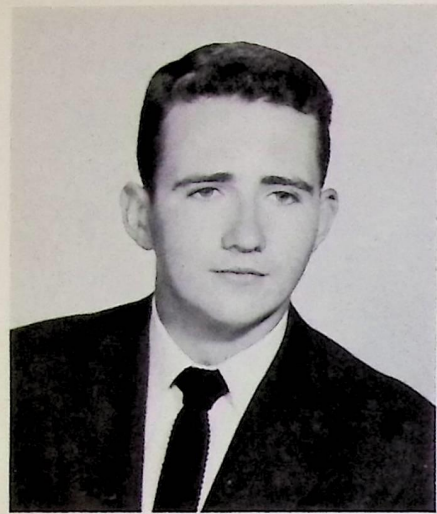

DICK MULLEN

Heaven without good society cannot be heaven.

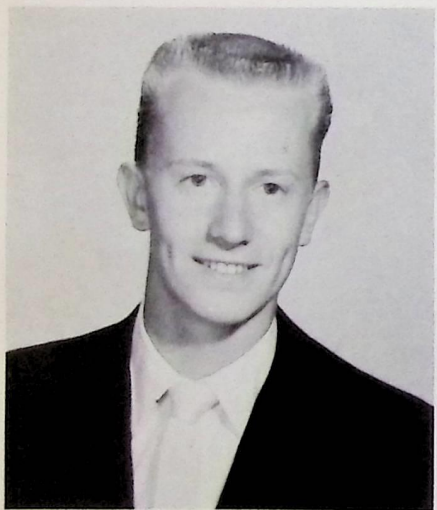

DICK NEEDHAM

Our votes went to Dick for his leadership.



MARILYN OBERDANK

So neat and sweet.



JOAN NELSON

The reward of effort is achievement.



MARIE O'DONNELL

It's so nice to be natural.

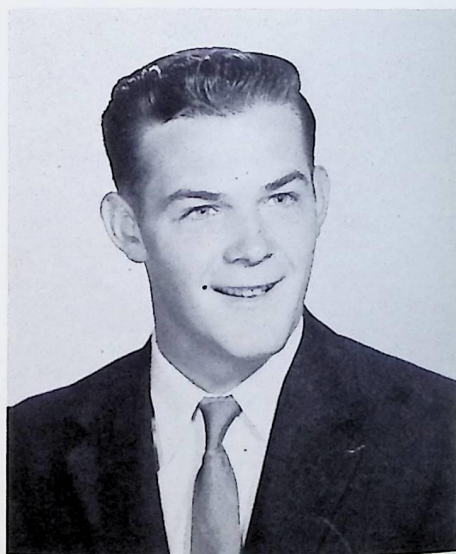

RONALD OLIPHANT

With his car he'll travel far.

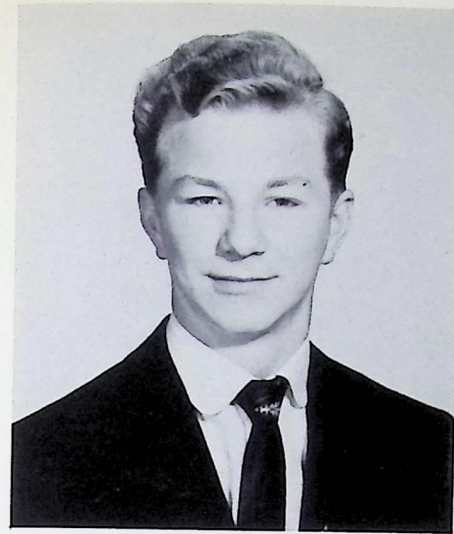

DENNIS OSTROW

You can depend on such a friend.

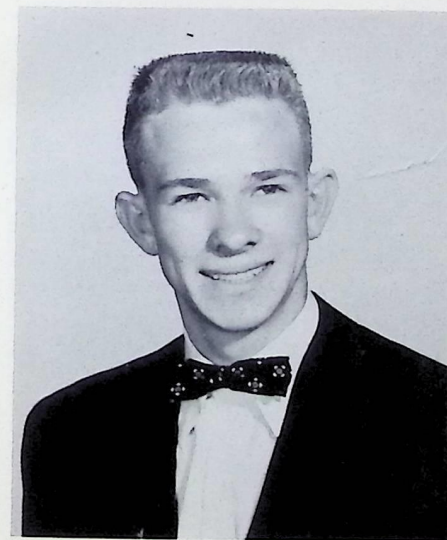

JUNIOR ORICK

Clothes don't make the man, but personality can.



KATHLEEN PARANISH

She'll never walk alone.

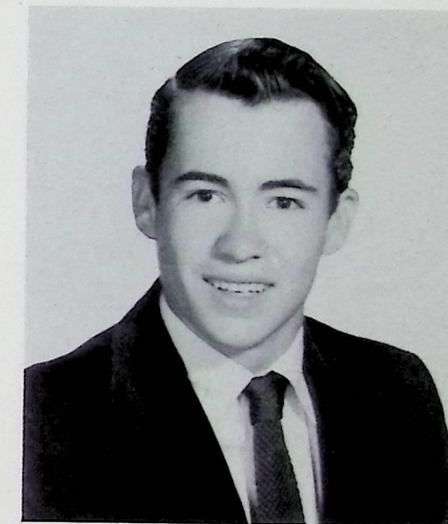

DICK PARKER

Today--small in frame; Tomorrow--tall in fame.



JOAN NELSON

The reward of effort is achievement.



MARILYN OBERDANK

So neat and sweet.



MARIE O'DONNELL

It's so nice to be natural.

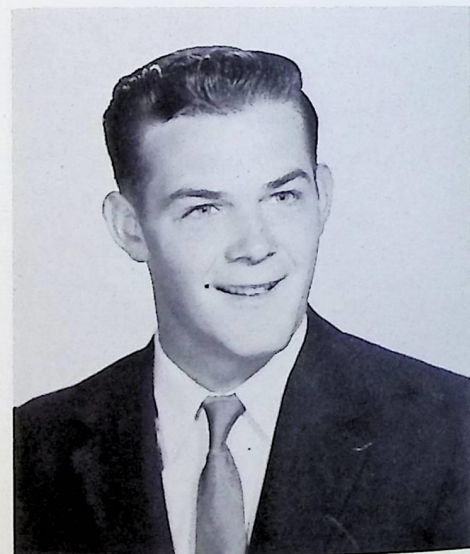

RONALD OLIPHANT

With his car he'll travel far.

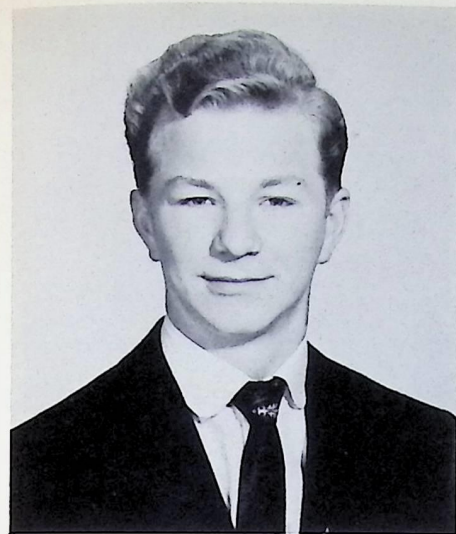

DENNIS OSTROW

You can depend on such a friend.

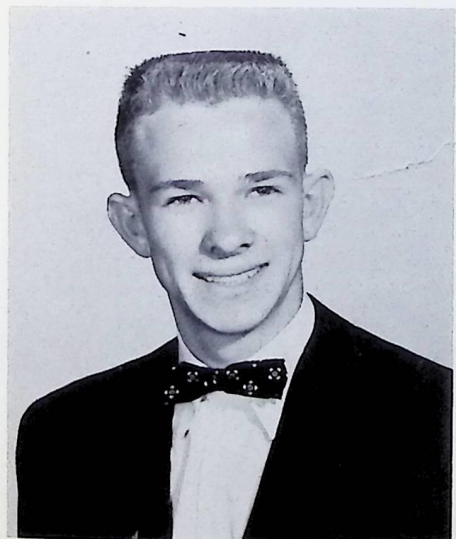

JUNIOR ORICK

Clothes don't make the man, but personality can.



KATHLEEN PARANISH

She'll never walk alone.



DICK PARKER

Today--small in frame; Tomorrow--tall in fame.



SUSAN PARKS

Ever let your pure heart be your unerring guide.

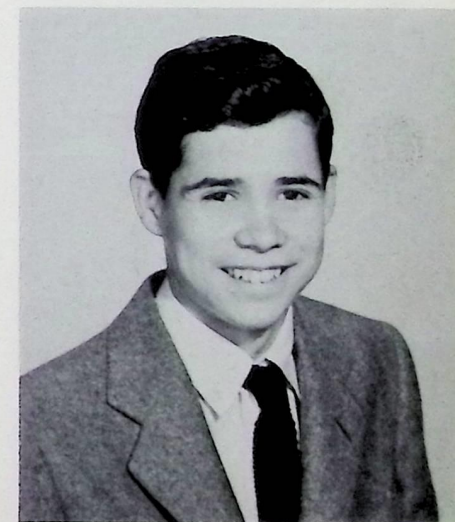

DON PARKER

Many a noble soul is hidden by a quiet exterior.



DARLENE PARMELE  
Full of pep and go.



ANN PASQUALONE  
Gentle disposition.

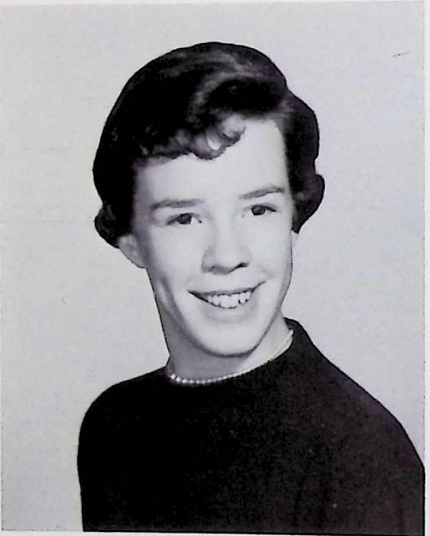

PHYLLIS PATTERSON  
A winning personality without the least formality.

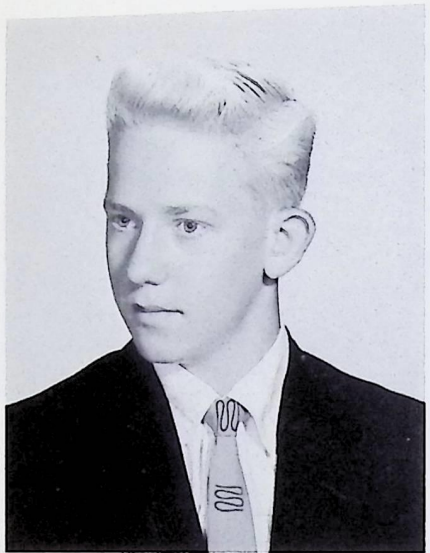

DAVE PELZ  
Leader of men, Follower of women.



WALTER PARRY  
The quiet type.

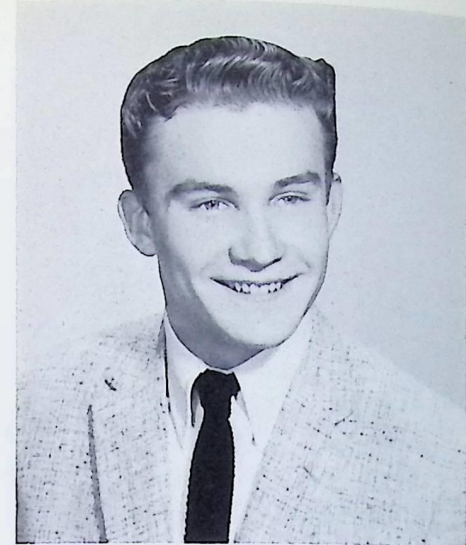

DICK PERKINS  
He does his work and goes his way.



JANET PERUSEK  
The height of delight.



BETH PETUNYA  
Ain't she sweet.



LOIS PLAISTED  
A nurse is what she wants to be; she will succeed, just wait and see.

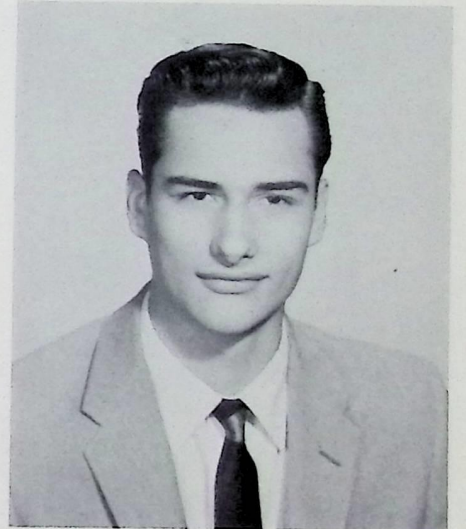

JERRY PLESCHER  
The tall, silent type.



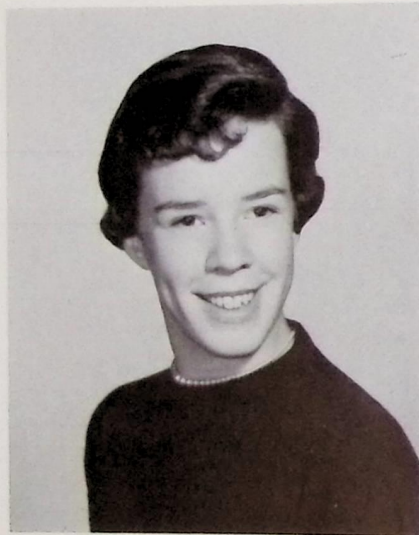

PHYLLIS PATTERSON

A winning personality without the least formality.

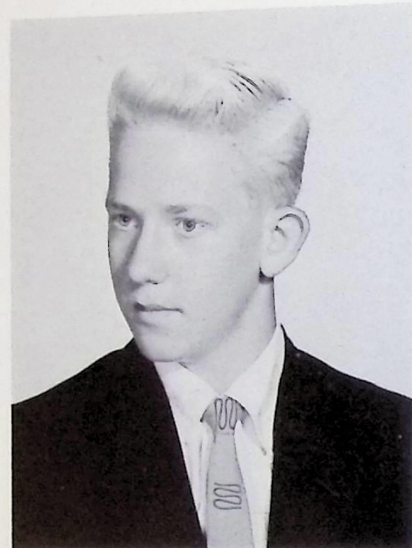

DAVE PELZ

Leader of men, Follower of women.



DICK PERKINS

He does his work and goes his way.



WALTER PARRY

The quiet type.



BETH PETUNYA

Ain't she sweet.



JANET PERUSEK

The height of delight.



LOIS PLAISTED

A nurse is what she wants to be; she will succeed, just wait and see.

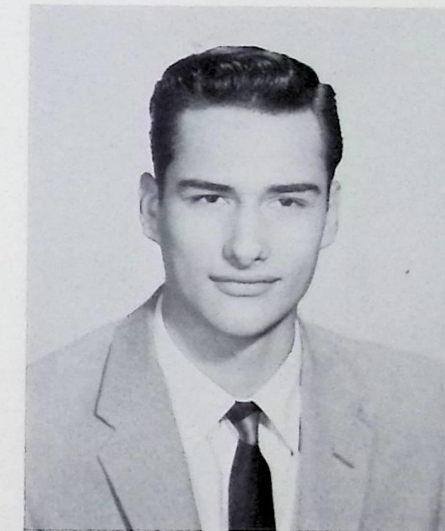

JERRY PLESCHER

The tall, silent type.

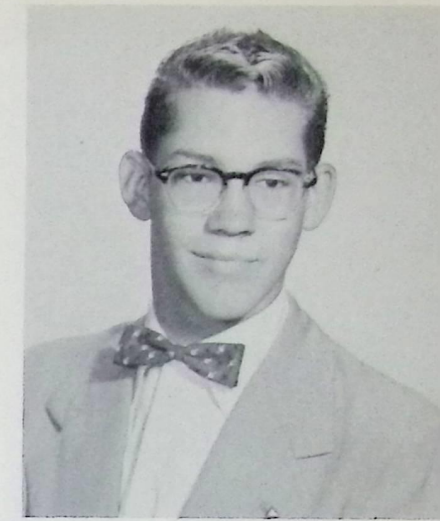

DON POOLE

Always a helping hand.



JUDY POE

Surely success will be hers.

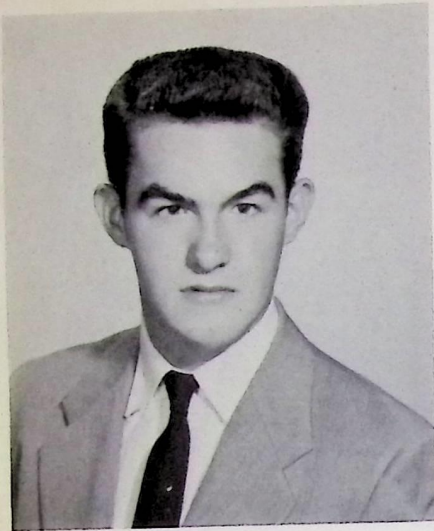

DALE PORTER  
Tennis is his racket.



JUDIE PRAHST  
A jolly good friend is she.



PAT PORTER  
Freckles go with a cheerful nature.

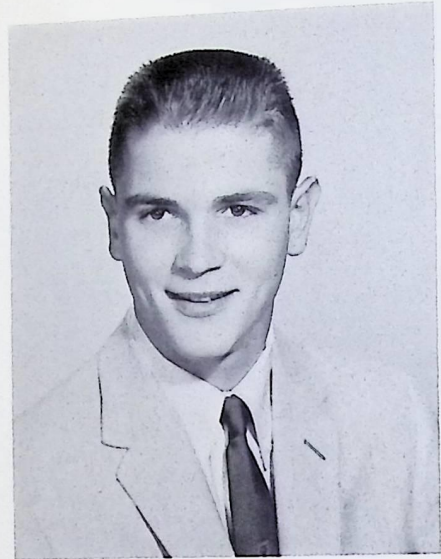

BILL PRINDLE  
What I need is a long, long rest.



SHIRLEY PUGEL  
Surely you will like Shirley.

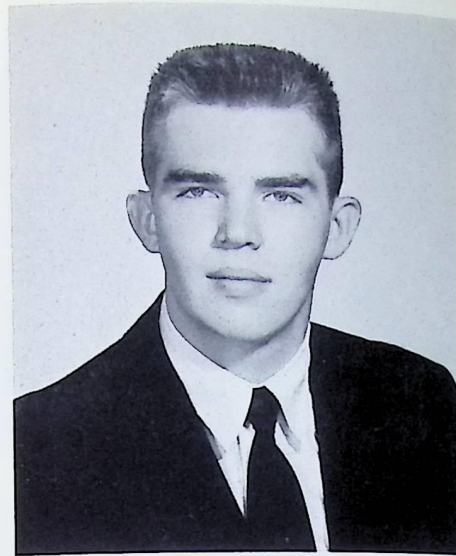

TED PRINDLE  
Why all this toil and trouble.



BARBARA PULFORD  
A quiet girl, but still she does her  
task with rare good will.

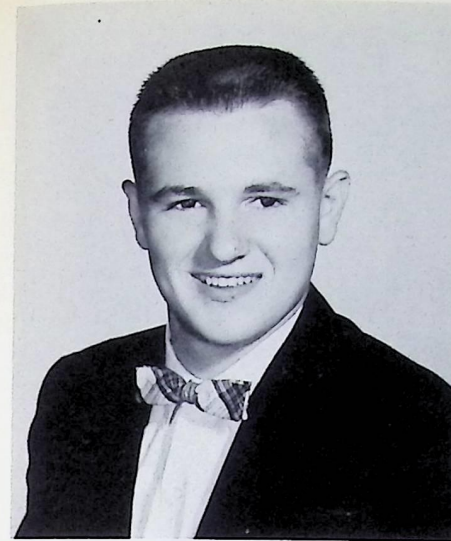

JIM RAUKER  
All American.



ARLEE REYNOLDS  
Skating through life.



ROCHELLE ROBERTS  
There is nothing so popular as  
goodness.



JUDIE PRAHST  
A jolly good friend is she.

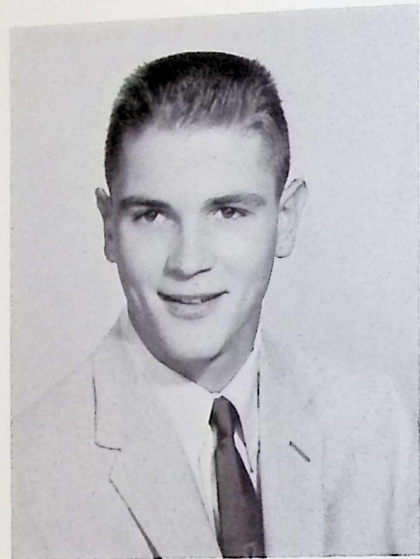

BILL PRINDLE  
What I need is a long, long rest.

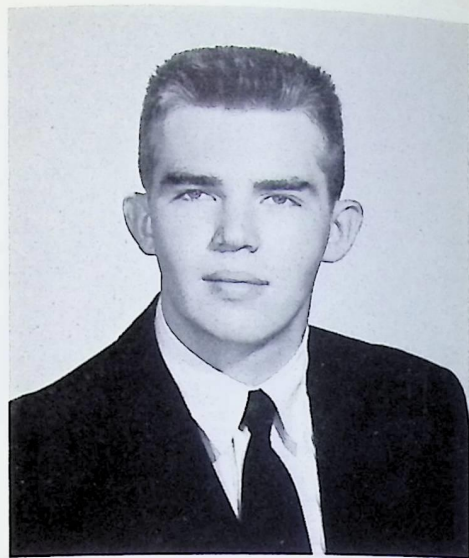

TED PRINDLE  
Why all this toil and trouble.



SHIRLEY PUGEL  
Surely you will like Shirley.

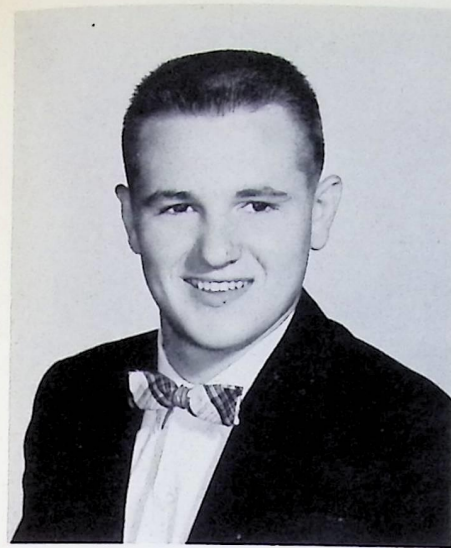

JIM RAUKER  
All American.



BARBARA PULFORD  
A quiet girl, but still she does her  
task with rare good will.



ARLEE REYNOLDS  
Skating through life.



ROCHELLE ROBERTS  
There is nothing so popular as  
goodness.



SANDRA ROSE  
The harder the work, the harder she  
works.



JUDY ROGERS  
She cheers for Willoughby and  
Willoughby cheers for her.

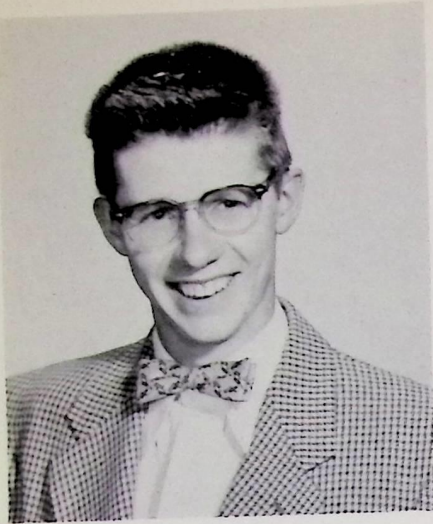

BRUCE ROWLAND  
Hot rod throttle jammer.

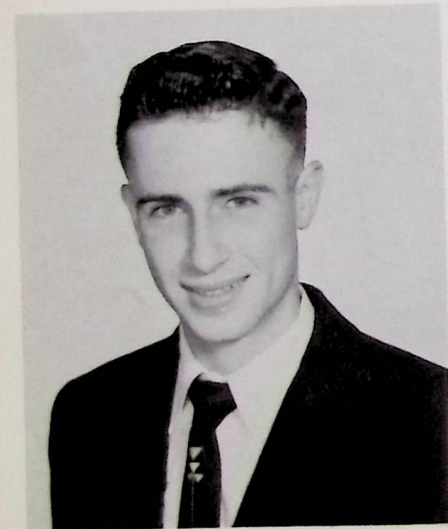

PHILLIP RUSSO  
To open a book brings profit.



JIM SABEL  
What we obtain too cheap we esteem too lightly.



MARILYN SCHAEFER  
Gracious lady of charm.



ELSIE SCHMITT  
Hair of red, heart of gold.



CAROL SCHRINER  
She's got something up her sleeve--a crazy bone.

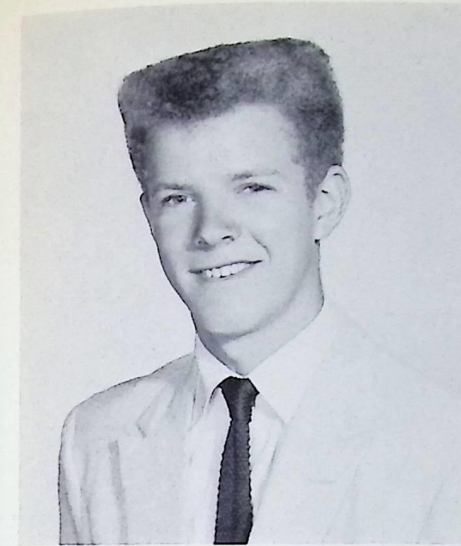

LARRY SCHWED  
Quietness is what we need.

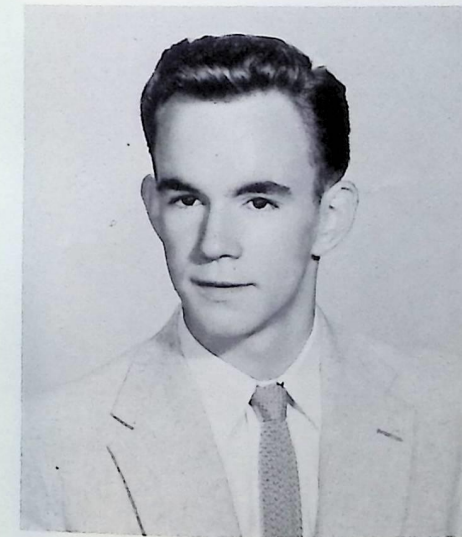

BILL SCHULTZ  
A boy worthy of all his friends.



MILTON SEALEY  
Silent, but heard.

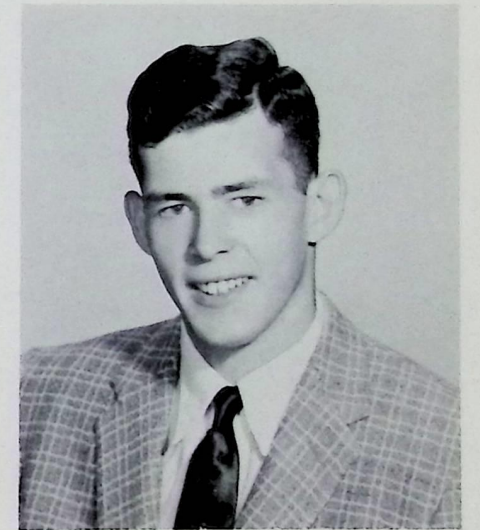

KEN SELANDER  
No man's enemy.

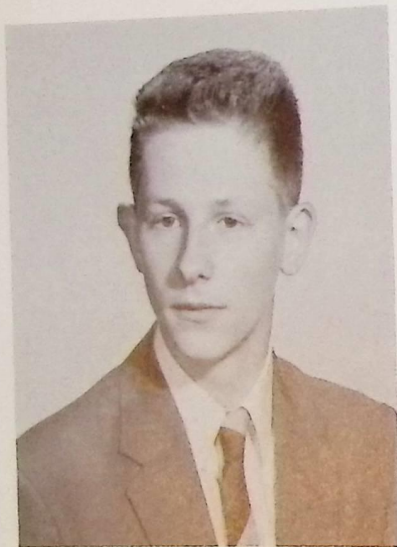

JIM SABEL

What we obtain too cheap we esteem too lightly.



MARILYN SCHAEFER

Gracious lady of charm.



ELSIE SCHMITT

Hair of red, heart of gold.



CAROL SCHRINER

She's got something up her sleeve--a crazy bone.

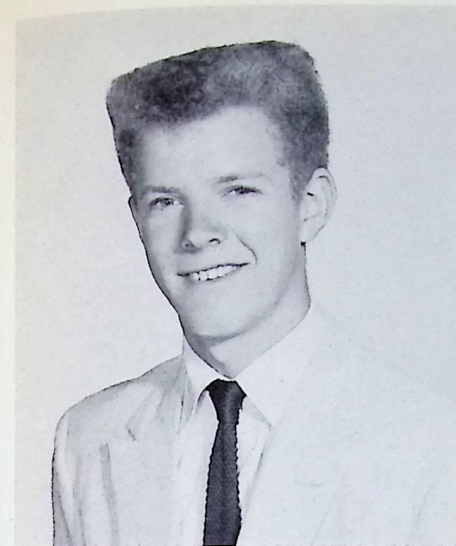

LARRY SCHWED

Quietness is what we need.

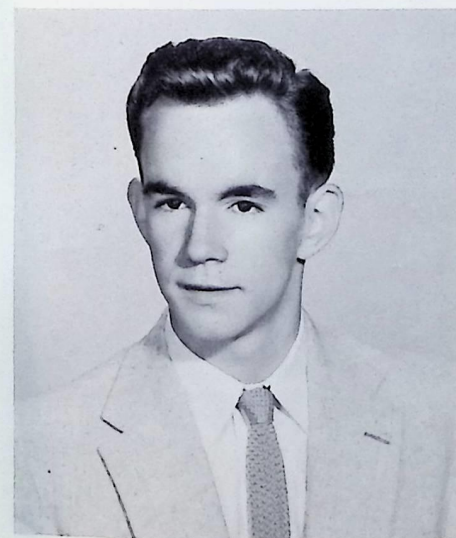

BILL SCHULTZ

A boy worthy of all his friends.

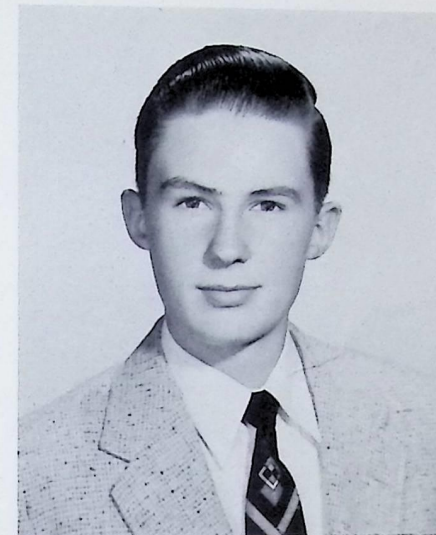

MILTON SEALEY

Silent, but heard.



KEN SELANDER

No man's enemy.



PHIL SEVERSON

If I don't get there today, I'll get there tomorrow.



DONNA SHARP

Her gift of gab is never drab.



FLORENCE SHARROCK

Is not making others happy the best of happiness?



ANITA SHAW

Personality is her "CROWN"



BOB SHERWOOD

To know is to appreciate.

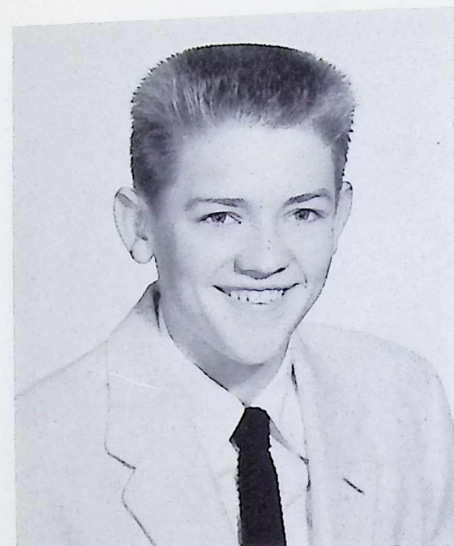

BOB SHOEMAKER

Thoughts are seeds of deeds.



KENNETH SLITER

He is just the quiet kind whose nature never varies.

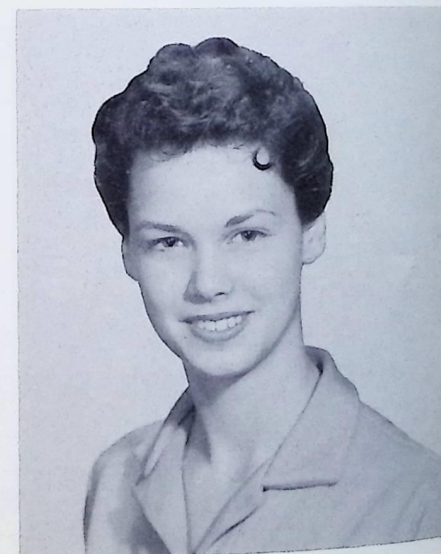

ELEANOR SMITH

She bobs her way on the waves of life.



ANNA MAE SNYDER

A heart for everyone.



CAROLE STAHLHUT

Her heart is surely in her work.

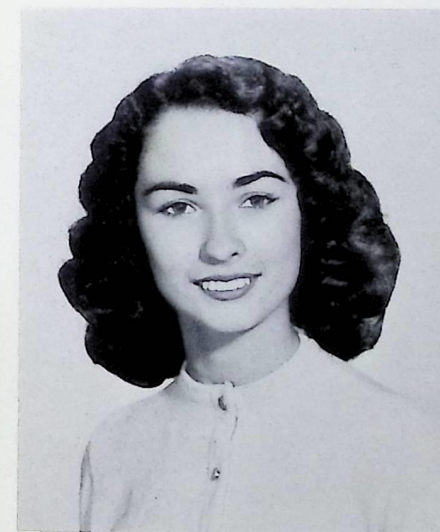

PATTI SMITH

A friendly gal with many pals.

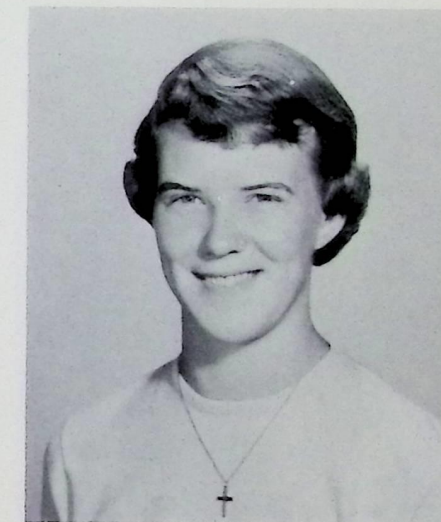

JUDY STENDEL

Music my rampart, and my only one.



BOB SHERWOOD

To know is to appreciate.

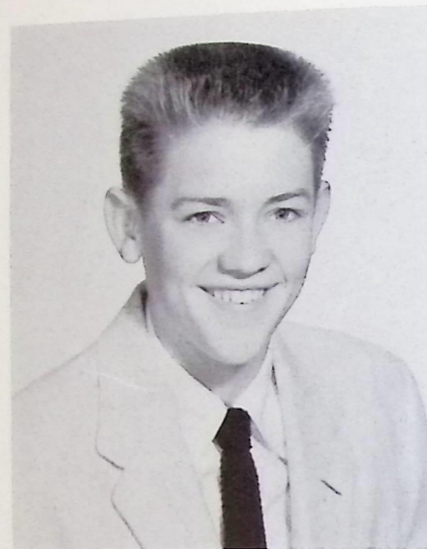

BOB SHOEMAKER

Thoughts are seeds of deeds.



KENNETH SLITER

He is just the quiet kind whose nature never varies.



ELEANOR SMITH

She bobs her way on the waves of life.



ANNA MAE SNYDER

A heart for everyone.



PATTI SMITH

A friendly gal with many pals.



CAROLE STAHLHUT

Her heart is surely in her work.

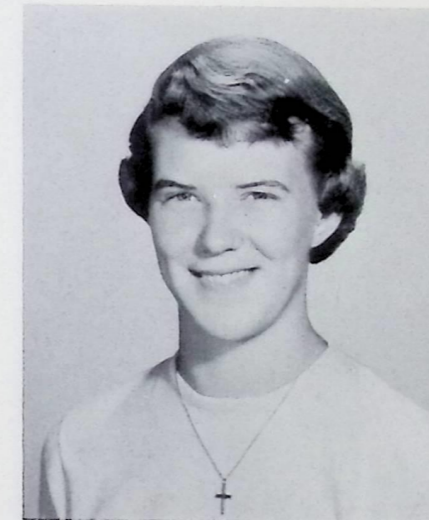

JUDY STENDEL

Music my rampart, and my only one.

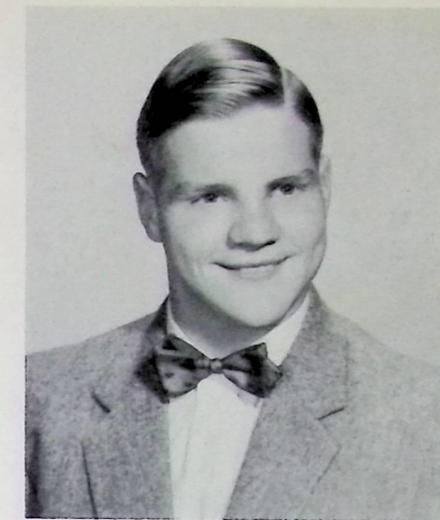

ALFRED STEPHEN

He pools his resources in everything he undertakes.



VIRGINIA STEWART

Oh what a chatterbox.



JIM STOIS

There are better things in life than textbooks.



JACKIE STONE

What she sets out to do, she does.



DOLORES TANNER

Always in a rush not to miss the fun.



SUSAN TEPLÉ

Actions not words count most.

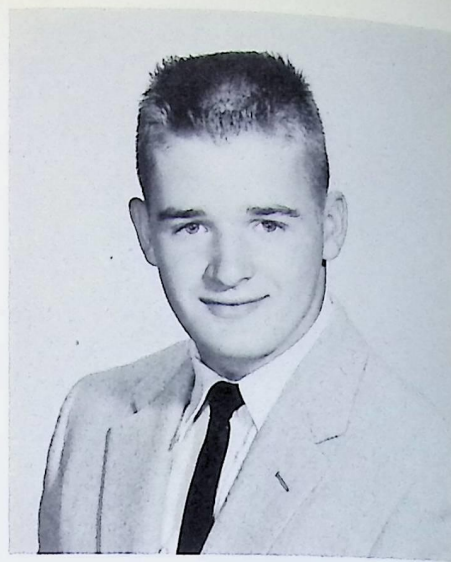

JOE THOMPSON

Where there's spirit there's Joe.

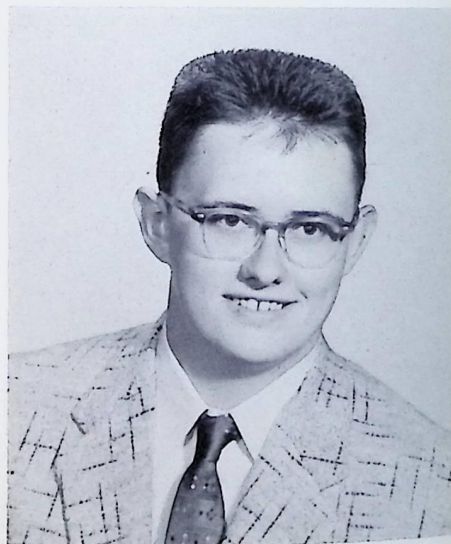

JIM TIMSON

He gives his thoughts no voice.



GLORIA TUTTLE

She has that certain twinkle in her eye.



NANCY TOLAND

A short, but happy story.



VICKY TYLER

She's Jim's "sweetheart," too.



CAROL VEIT

Hold fast to your dreams.





DOLORES TANNER

Always in a rush not to miss the fun.



SUSAN TEPLÉ

Actions not words count most.

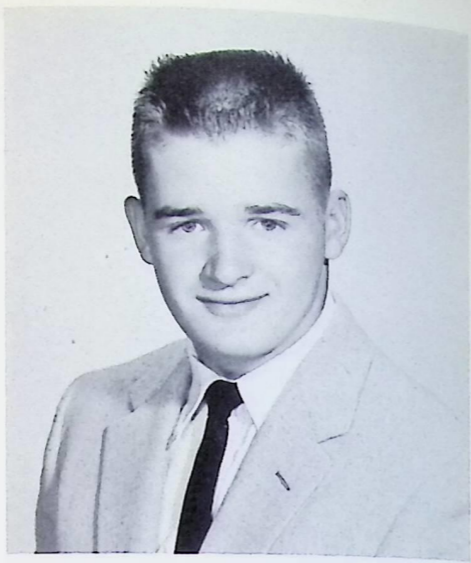

JOE THOMPSON

Where there's spirit there's Joe.



JIM TIMSON

He gives his thoughts no voice.



GLORIA TUTTLE

She has that certain twinkle in her eye.



NANCY TOLAND

A short, but happy story.



VICKY TYLER

She's Jim's "sweetheart," too.



CAROL VEIT

Hold fast to your dreams.



JIM VIOL

Each man to his own desires.



TOM VIRANT

Calm "cool" and collected.



BEVERLY WAGNER

If silence were golden she'd be a millionaire.

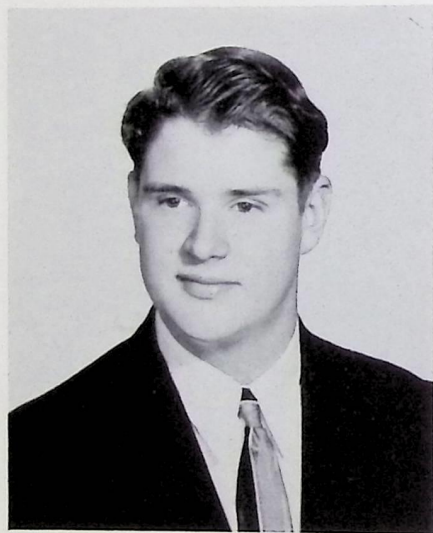

JIM WALLACE

A boy with the tape recorder.

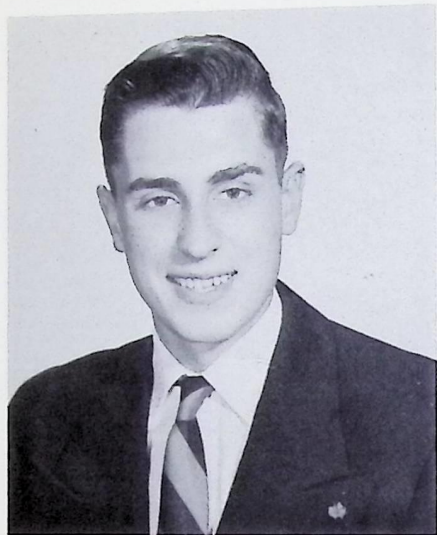

BILL WARGO

If you can take it like a man, you are one.



MONA LEA WEAVER

She walks in beauty like a song.



JOE WASICEK

I do the things I like to do.



BOB WENDELL

Wit and wisdom are born with a man.



ROBERTA WIDGREN

Sweetness wrapped up in a pretty package.



NANCY WILLIAMS

She shines from within.

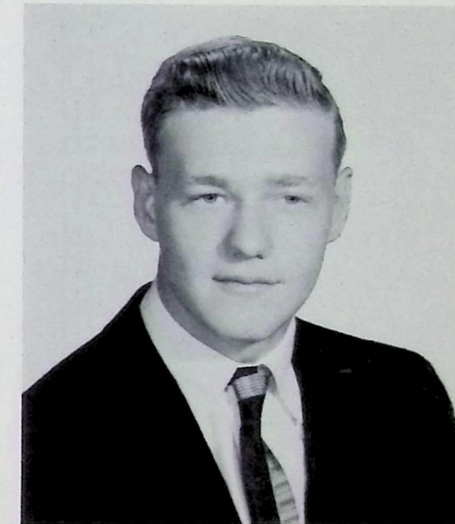

HENRY WILSON

An easy going guy.

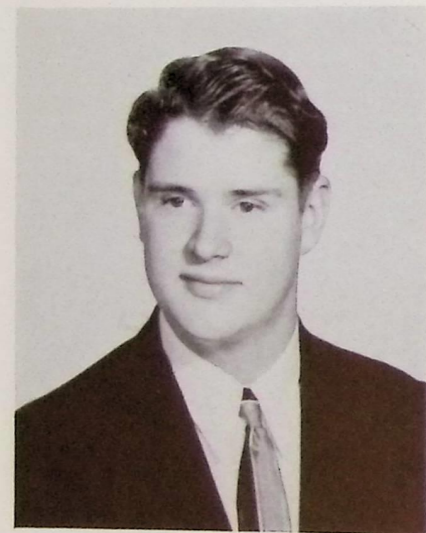

JIM WALLACE

A boy with the tape recorder.

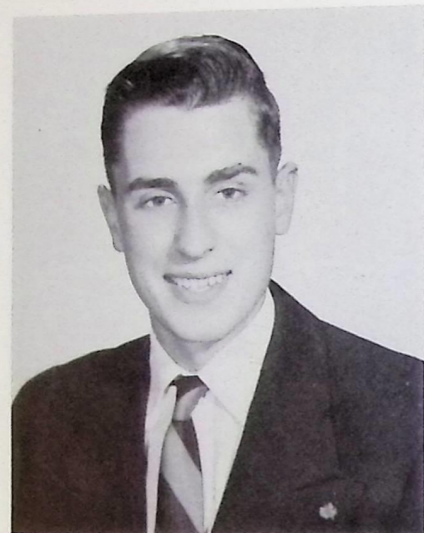

BILL WARGO

If you can take it like a man, you are one.

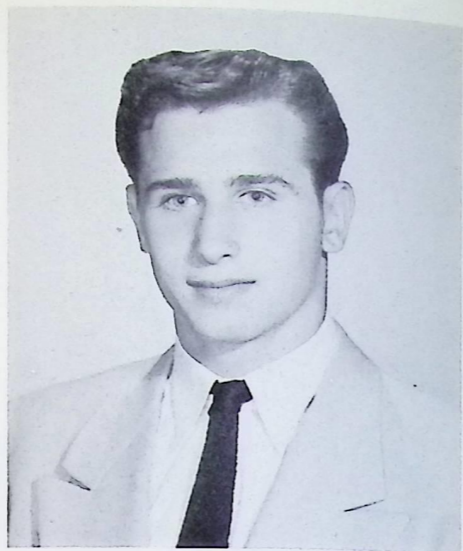

JOE WASICEK

I do the things I like to do.



MONA LEA WEAVER

She walks in beauty like a song.



ROBERTA WIDGREN

Sweetness wrapped up in a pretty package.

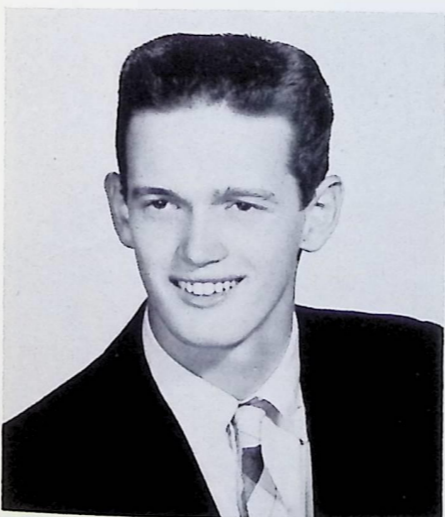

BOB WENDELL

Wit and wisdom are born with a man.



NANCY WILLIAMS

She shines from within.

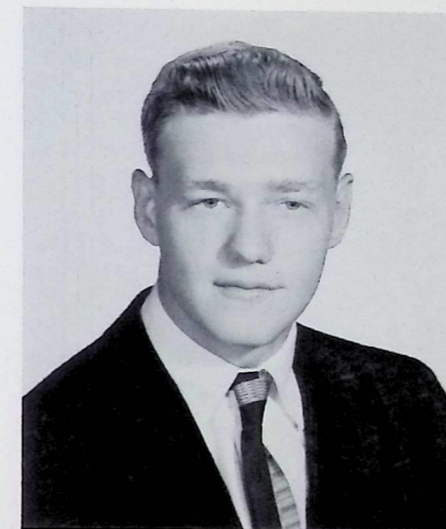

HENRY WILSON

An easy going guy.

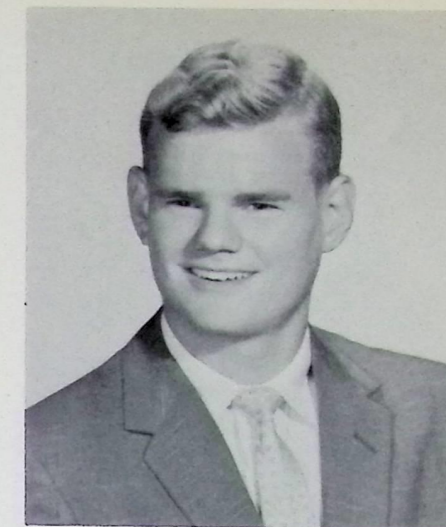

BRUCE WOTRING

Always leave 'em laughing.



KAREN WRIGHT

Her laughter rings throughout the halls of W.H.S.



JOAN WILSON

An outward and visible sign of an inward and spiritual grace.



GAIL YORK

How far this little candle throws her beams.

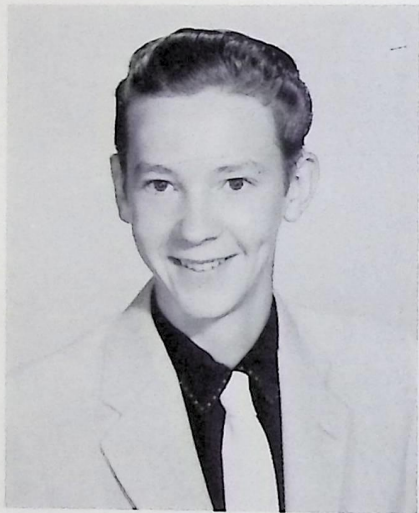

DICK YOUNG

Little body with a mighty heart.



KENT ZAVODNY

There are cars in his future.

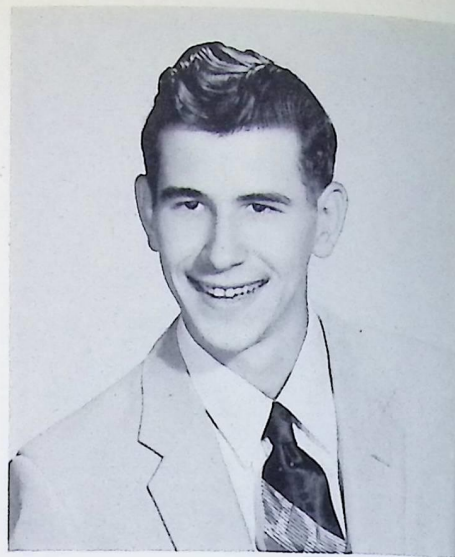

BOB ZINKAND

Last but still to be remembered.

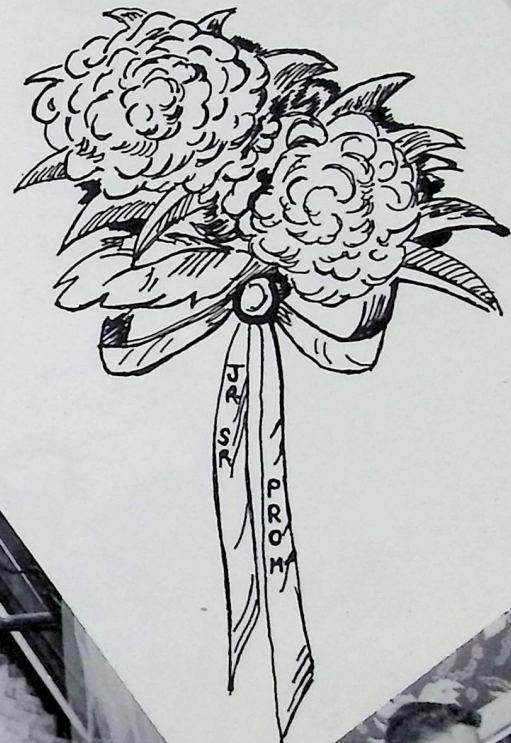
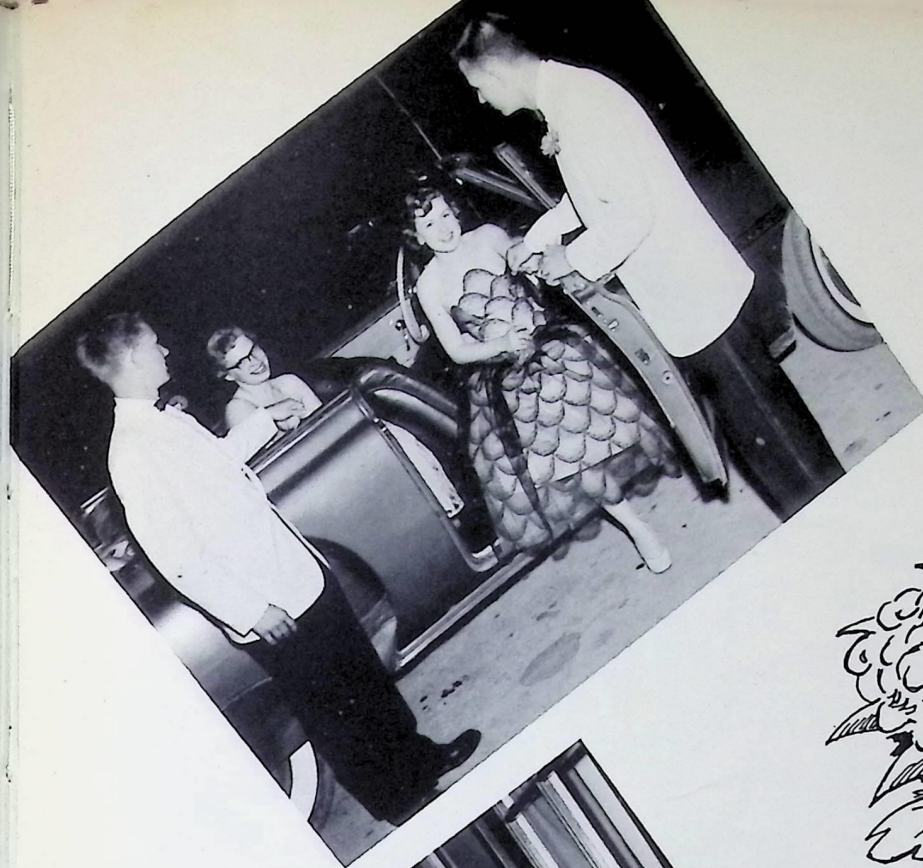

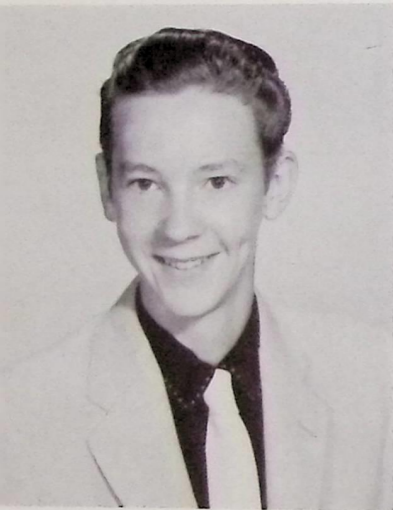

DICK YOUNG

Little body with a mighty heart.



KENT ZAVODNY

There are cars in his future.

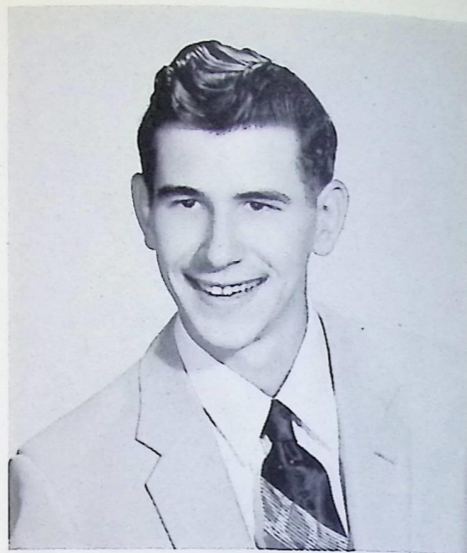

BOB ZINKAND

Last but still to be remembered.

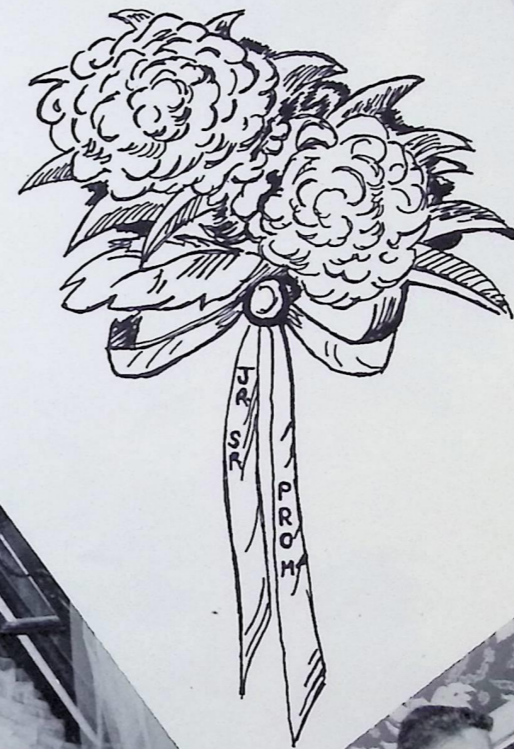

# PERSONALITY POLL



BEST DRESSED JUNIOR ORICK

BEST DRESSED SUE HENGST



PRETTIEST HAIR RONNIE LANG

PRETTIEST HAIR PAT CLARK



BEST PERSONALITY DAVE PELTZ  
BEST PERSONALITY ANITA SHAW

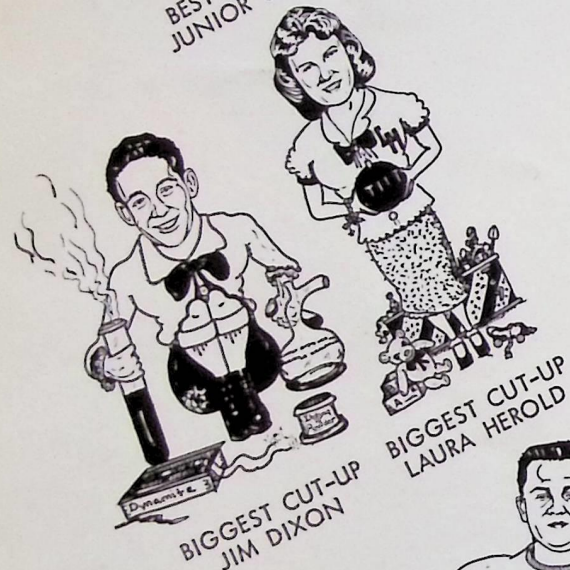

BIGGEST CUT-UP JIM DIXON

BIGGEST CUT-UP LAURA HEROLD



MOST ATHLETIC ABILITY JIM RAUKER



MOST ATHLETIC ABILITY NANCY LEONELLO



PRETTIEST SMILE TOM GIELING



PRETTIEST SMILE JUDY STENDEL



MOST MUSICAL ABILITY DALE PORTER  
MOST MUSICAL ABILITY SUSIE PARKS



WITTIEST BOB WENDELL  
WITTIEST GAIL YORK



SHORTEST BOY GLEN BELL  
SHORTEST GIRL GLENDA BELL



TALLEST DICK MILLER  
TALLEST JUDY PRAHST



BEST ACTRESS CYNTHIA BOUTON

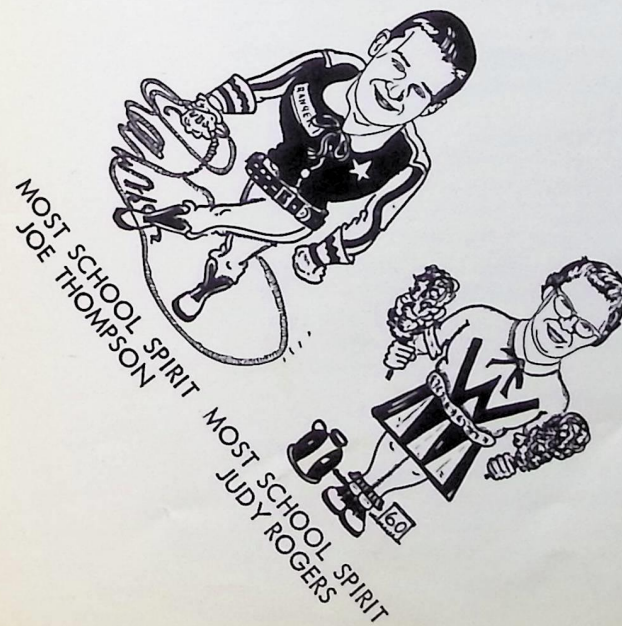

MOST SCHOOL SPIRIT JOE THOMPSON  
MOST SCHOOL SPIRIT JUDY ROGERS



SHYEST KEN SLITER  
SHYEST ANITA MUCCINI

MOST LIKELY TO SUCCEED PHYLLIS PATTERSON

# PERSONALITY POLL



PRETTIEST HAIR  
RONNIE LANG

PRETTIEST HAIR  
PAT CLARK



BEST PERSONALITY DAVE PELTZ  
BEST PERSONALITY ANITA SHAW



WITTIEST BOB WENDELL  
WITTIEST GAIL YORK



SHORTEST BOY GLEN BELL  
SHORTEST GIRL GLENDA BELL



TALLEST DICK MILLER  
TALLEST JUDY PRAHST



MOST ATTRACTIVE DICK MULLEN  
MOST ATTRACTIVE MONA WEAVER



BEST ACTRESS CYNTHIA BOUTON  
BEST ACTOR DICK NEEDHAM



PRETTIEST SMILE TOM GIELING  
PRETTIEST SMILE JUDY STENDEL



MOST MUSICAL ABILITY DALE PORTER  
MOST MUSICAL ABILITY SUSIE PARKS



MOST SCHOOL SPIRIT JOE THOMPSON  
MOST SCHOOL SPIRIT JUDY ROGERS



SHYEST KEN SLITER  
SHYEST ANITA MUCCINI

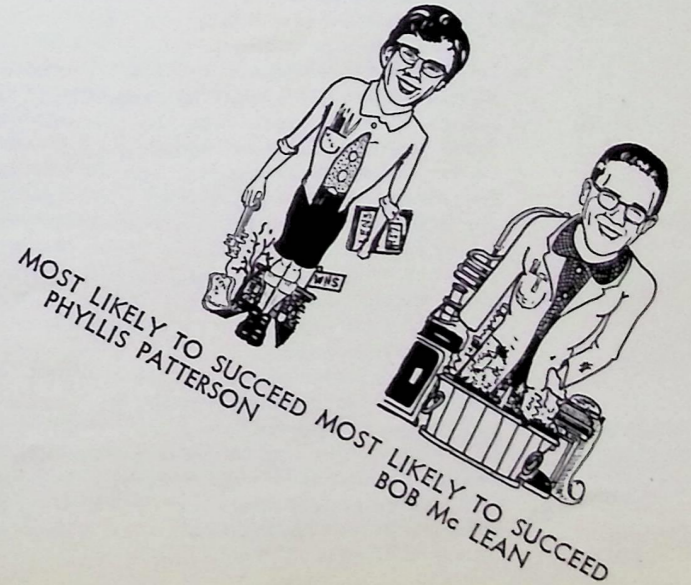

MOST LIKELY TO SUCCEED PHYLLIS PATTERSON  
MOST LIKELY TO SUCCEED BOB Mc LEAN

ATHLETIC ABILITY MOST ATHLETIC ABILITY  
TOM RAUKER NANCY LEONELLO

# WANTED

Ray Mominey's pipe. . .  
Junior Orick's clothes. . .  
The Twins at WHS:  
    The Parkers, Dick and Don; the Bells,  
    Glenn and Glenda. . .  
Joanie Nelson's cheerfulness. . .  
Susie Park's enthusiasm and sincerity. . .  
Suzie Hengst's artistic talent. . .  
Patty Clarke's beautiful hair. . .  
Mona Lea Weaver's wonderful voice. . .  
Judy Stendel's friendly smile. . .  
Bob Wendell's wit. . .  
Audrey Bailey's friendliness. . .  
Sally Farran's listening and understanding. . .  
Nancy Leonello's athletic ability. . .  
Our salutatorian, Norine Dey. . .  
The engagement rings worn so proudly by  
    Gail Antonin, Carole Veit, Kathleen Paranish,  
    Sonja Lamos, Gloria Tuttle, Anna May Snyder,  
    Norma Largen, Darlene Parmele, Carol Snyder,  
    Phyllis Mericle, Pat Hadley. . .  
"W" Club president, Karen Wright. . .  
Bobbi Widgren's petticoated full skirts. . .  
Band Prexy, Linda Donovan. . .  
To replace and fill Bob McLean's tiny  
    parking place. . .  
Our Queen, Anita Shaw. . .  
Vivacious Barb Dickson. . .  
Ann Allen's niceness. . .  
Patty Boykin's tinyness. . .  
Flo Chisholm's helpfulness. . .  
Larry Goldrick's brains. . .  
Margie Mestrovich's bubbling personality. . .  
Nancy Williams' pretty face. . .  
Bruce Wotring's large eating habits. . .  
Donna Waite's understanding. . .  
Bill Wargo's pretty eyes. . .  
Jim Wallace's recordings. . .  
Nicky Lippens' versatility. . .  
Roberta Litwiler's generosity. . .  
Marie Ciulla's sweetness. . .  
Jerry Mitchell's curly hair. . .  
Dick Young's dimples. . .  
Dave Pelz's flirtatious eyes. . .  
John Matz's dead mouse in choir. . .  
Sally Fedor's "Yoo-hoo". . .  
Billy Floyd's long runs for touchdowns. . .  
Sedate Johanna Berg. . .  
Eddie Kuhar's ruggedness. . .  
Bill Klein's even temper. . .  
Nancy Morlock's cuteness. . .

# TO

# REPLACE

Anita Muccini's shyness. . .  
Carol Schriener's bounciness. . .  
Susie Estes' short hair. . .  
Bob Fox's coronet. . .  
Barb Gau's niceness. . .  
Vivacious Kitty Garrick. . .  
Margie Harris' sweetness. . .  
Dick Hartman's alertness (?) in class. . .  
Ron Herrick's interest in the Jr. Class. . .  
Bob Hovance's friendship with Mr. Edmunds. . .  
Gary Jarmusch's great personality. . .  
Quiet Bill Jazbec. . .  
Nancy Juck's blue eyes. . .  
Ernest Kellner's shortness. . .  
Art Kless' ability of agreeing with teachers. . .  
Santha Kohler's home ec ability. . .  
Mary Ann Kraker as head office page. . .  
Sam Lambo's angelic looks. . .  
Janice Miller's beautiful clothes. . .  
Marolyne Miller's rich voice. . .  
Betty Mitrovich's cooking ability. . .  
Marlene Morrow's athletic ability. . .  
Dick Mullen's attractiveness. . .  
Dennie Ostrow's library job. . .  
Dick Perkin's ambition. . .  
Janet Perusek's giggle. . .  
Beth Petunya's shy friendliness. . .  
Jerry Pike's interest in music. . .  
Lois Plaisted's cheerfulness and understanding. . .  
Judy Poe's interest in the Searchlight. . .  
Don Poole's helping hand in the concession stand. . .  
Pat Porter's freckles. . .  
Ted Prindle's interest in electronics. . .  
Shirley Pugel's laugh. . .  
Barb Pulford's many interests. . .  
Sandy Rose's sweetness. . .  
Larry Schwed's husky voice. . .  
Marilyn Schaefer's interest in choir. . .  
Milton Sealey's intense interest in Latin. . .  
Ken Selander's general bigness. . .  
Phil Severson in Chemistry lab. . .  
Donna Sharp's prowess in Home Ec. . .  
Flo Sharrock's swell personality. . .  
Bob Sherwood's casual manner. . .  
Shy Kenny Sliter. . .  
Friendly Patti Smith. . .  
Carole Stahlhut's intelligence. . .  
Bob Houston's happiness. . .  
Catherine Jackson's brightness. . .  
Fred Hoffman's ability to keep a secret. . .

Likeable Al Stephen. . .  
Jim Stois' haircut. . .  
Jackie Stone's neatness. . .  
Jim Rauker's athletic ability. . .  
Kurt Lohmeyer's fabulous scholarship. . .  
Everett Fertig's hot-rod. . .  
Dick Miller's ability to dunk the ball. . .  
Buddy Hauser's pictures. . .  
WHS red-heads--Carolyn Bomgardner, Harold Dietz, Jean  
    Alexander. . .  
Phil Russo's electronic mind. . .  
Bruce Roland's mechanical skill. . .  
Scatter-brained Eleanor Smith. . .  
Joe Thompson's trick arm. . .  
Janice Sutton's politeness. . .  
Joan Wilson's quietness. . .  
Gail York's comical anecdotes. . .  
Audrey Foutz's cute nose. . .  
Tom Geiling's interest in the cheerleaders. . .  
Ronnie Lang as Elvis. . .  
Alice Huston's dressmaking ability. . .  
Don Allen's freshness. . .  
Lance Buhl's keenness of Mind. . .  
Tom Virant's tallness. . .  
Ron Morgan's jokes. . .  
Peggy Morenz's generosity. . .  
Arlene Mancini's four year membership in the "W" Club.  
Mike Evans' subtle humor. . .  
Lee Knapton's British accent. . .  
Scintillating Cindy Bouton. . .  
Class President, Dick Needham. . .  
Viv Dodds' stately grace. . .  
Carol Sue Corbett's pierced ears. . .  
Gil Chase's compactness. . .  
Ray Brezic's welcome silence. . .  
Mary Baker's gum. . .  
Ivan Kenyon's deep, deep voice. . .  
Roberta Hall's comeliness. . .  
Judy Prahst's jolliness. . .  
Annie Pasquelone's long name. . .  
Rochelle Roberts' attentiveness. . .  
Rod Faulk's love of school. . .  
Kent Zavodny's crew cut (?) . . .  
Art Melton's orange pants. . .  
Tiny Alicia Lann. . .  
Don Fairbanks in second period English. . .  
Ron Beyerle's glasses. . .  
Richard Dennis' solomnity. . .  
Brom Bilton's kinky hair. . .  
Vicky Tyler, "Outside the Shower Room". . .  
Dale Porter's musical ability. . .  
Bouncy Sally Gidley. . .  
Business manager of our play, Barb Halaburda. . .  
Class cut-up, Laura Herold. . .  
John Lees' hearty laugh. . .  
Bob Brenenstuhl's husky build. . .  
DiAnne Barnard's gaiety. . .

Nancy Toland's quiet politeness. . .  
Jim Ackroyd's bass voice. . .  
Myrna Bittner's interest in bowling. . .  
Little Phyllis Lockhard. . .  
Judy Brod's ready smile. . .  
Devilish Gary Forsberg. . .  
Joe Wasicek's smile. . .  
Chuck Loach's crew-cut. . .  
Dennis Lino's blue eyes. . .  
Henry Wilson's glasses. . .  
Jim Viol!. . .  
Bev Wagner's sweetness. . .  
Sue Teple's snapping brown eyes. . .  
Dolores Tanner's attractive smile. . .  
Bob Shoemaker's flat top. . .  
Studios Jim Timson. . .  
Baseball Playing Jerry Lattimore. . .  
Pretty Pat Krinsky. . .  
Pete Matousek's resemblance to Elvis.  
Al Heltman's drum. . .  
Donna Hogg's tiny feet. . .  
Bob Zinkand's last place in the alpha  
Barb Mihalick's skating ability. . .  
Alberta Bohnert's pretty clothes. . .  
Ron Destro and Joan Maljaric. . .  
Tall Elmer Crosier. . .  
Margaret Ducsay's nickname-"Dolly"  
Eddie Brott on the basketball court. . .  
Quiet (?) Gordon Caudill. . .  
Friendly Dick Cox. . .  
Gaynol Crocker's LENS salesmanship.  
Hal Hendershot's kiss for the Queen.  
Carol Lauten's ability in dramatics. . .  
Head songbirds, Ginny Stewart and Ji.  
Judy Rogers' school spirit. . .  
Dan Kennedy's prowess in physics. . .  
Phyllis Patterson's 4. average. . .  
Carolyn Blazy's dancing ability. . .  
Jane Buchner's explosive combination  
Quiet 'n' nice, Ida Egleston. . .  
Greg Fox's winning way. . .  
Bob Gongas' mild manner. . .  
Karl Gross' German accent. . .  
Micheala Hiebert's newness to WHS. . .  
Jim Heltman's sports stories. . .  
John Stange's gentleness. . .  
Marilyn Oberdank's cute hair. . .  
Marie O'Donnell's smiling face. . .  
Gerald Plescher's all-aroundness. . .  
Arlee Reynold's humor. . .  
Bill Prindle and Ron Prygo!. . .  
Jean Hull's daintiness. . .  
Pat Frazier's attractiveness. . .  
Betsy Crego's sense of humor. . .  
Bernadine Colagross' lovely personalit.  
Louise Cecelic's sentimentality. . .  
Elaine Chesnes' fairness. . .



## D

## TO

## REPLACE

Anita Muccini's shyness. . .  
 Carol Schriener's bounciness. . .  
 Susie Estes' short hair. . .  
 Bob Fox's coronet. . .  
 Barb Gau's niceness. . .  
 Vivacious Kitty Garrick. . .  
 Margie Harris' sweetness. . .  
 Dick Hartman's alertness (?) in class. . .  
 Ron Herrick's interest in the Jr. Class. . .  
 Bob Hovance's friendship with Mr. Edmunds. . .  
 Gary Jarmusch's great personality. . .  
 Quiet Bill Jazbec. . .  
 Nancy Juck's blue eyes. . .  
 Ernest Kellner's shortness. . .  
 Art Kless' ability of agreeing with teachers. . .  
 Santha Kohler's home ec ability. . .  
 Mary Ann Kraker as head office page. . .  
 Sam Lambo's angelic looks. . .  
 Janice Miller's beautiful clothes. . .  
 Marolyne Miller's rich voice. . .  
 Betty Mitrovich's cooking ability. . .  
 Marlene Morrow's athletic ability. . .  
 Dick Mullen's attractiveness. . .  
 Dennie Ostrow's library job. . .  
 Dick Perkin's ambition. . .  
 Janet Perusek's giggle. . .  
 Beth Petunya's shy friendliness. . .  
 Jerry Pike's interest in music. . .  
 Lois Plaisted's cheerfulness and understanding. . .  
 Judy Poe's interest in the Searchlight. . .  
 Don Poole's helping hand in the concession stand. . .  
 Pat Porter's freckles. . .  
 Ted Prindle's interest in electronics. . .  
 Shirley Pugel's laugh. . .  
 Barb Pulford's many interests. . .  
 Sandy Rose's sweetness. . .  
 Larry Schwed's husky voice. . .  
 Marilyn Schaefer's interest in choir. . .  
 Milton Sealey's intense interest in Latin. . .  
 Ken Selander's general bigness. . .  
 Phil Severson in Chemistry lab. . .  
 Donna Sharp's prowess in Home Ec. . .  
 Flo Sharrock's swell personality. . .  
 Bob Sherwood's casual manner. . .  
 Shy Kenny Sliter. . .  
 Friendly Patti Smith. . .  
 Carole Stahlhut's intelligence. . .  
 Bob Houston's happiness. . .  
 Catherine Jackson's brightness. . .  
 Fred Hoffman's ability to keep a secret. . .

Likeable Al Stephen. . .  
 Jim Stois' haircut. . .  
 Jackie Stone's neatness. . .  
 Jim Rauker's athletic ability. . .  
 Kurt Lohmeyer's fabulous scholarship. . .  
 Everett Fertig's hot-rod. . .  
 Dick Miller's ability to dunk the ball. . .  
 Buddy Hauser's pictures. . .  
 WHS red-heads--Carolyn Bomgardner, Harold Dietz, Jean Alexander. . .  
 Phil Russo's electronic mind. . .  
 Bruce Roland's mechanical skill. . .  
 Scatter-brained Eleanor Smith. . .  
 Joe Thompson's trick arm. . .  
 Janice Sutton's politeness. . .  
 Joan Wilson's quietness. . .  
 Gail York's comical anecdotes. . .  
 Audrey Foutz's cute nose. . .  
 Tom Geiling's interest in the cheerleaders. . .  
 Ronnie Lang as Elvis. . .  
 Alice Huston's dressmaking ability. . .  
 Don Allen's freshness. . .  
 Lance Buhl's keenness of Mind. . .  
 Tom Virant's tallness. . .  
 Ron Morgan's jokes. . .  
 Peggy Morenz's generosity. . .  
 Arlene Mancini's four year membership in the "W" Club.  
 Mike Evans' subtle humor. . .  
 Lee Knapton's British accent. . .  
 Scintillating Cindy Bouton. . .  
 Class President, Dick Needham. . .  
 Viv Dodds' stately grace. . .  
 Carol Sue Corbett's pierced ears. . .  
 Gil Chase's compactness. . .  
 Ray Brezic's welcome silence. . .  
 Mary Baker's gum. . .  
 Ivan Kenyon's deep, deep voice. . .  
 Roberta Hall's comeliness. . .  
 Judy Prahst's jolliness. . .  
 Annie Pasquelone's long name. . .  
 Rochelle Roberts' attentiveness. . .  
 Rod Faulk's love of school. . .  
 Kent Zavodny's crew cut (?) . . .  
 Art Melton's orange pants. . .  
 Tiny Alicia Lann. . .  
 Don Fairbanks in second period English. . .  
 Ron Beyerle's glasses. . .  
 Richard Dennis' solemnity. . .  
 Brom Bilton's kinky hair. . .  
 Vicky Tyler, "Outside the Shower Room". . .  
 Dale Porter's musical ability. . .  
 Bouncy Sally Gidley. . .  
 Business manager of our play, Barb Halaburda. . .  
 Class cut-up, Laura Herold. . .  
 John Lees' hearty laugh. . .  
 Bob Brenenstuhl's husky build. . .  
 DiAnne Barnard's gaiety. . .

Nancy Toland's quiet politeness. . .  
 Jim Ackroyd's bass voice. . .  
 Myrna Bittner's interest in bowling. . .  
 Little Phyllis Lockhard. . .  
 Judy Brod's ready smile. . .  
 Devilish Gary Forsberg. . .  
 Joe Wasicek's smile. . .  
 Chuck Loach's crew-cut. . .  
 Dennis Lino's blue eyes. . .  
 Henry Wilson's glasses. . .  
 Jim Viol!. . .  
 Bev Wagner's sweetness. . .  
 Sue Teple's snapping brown eyes. . .  
 Dolores Tanner's attractive smile. . .  
 Bob Shoemaker's flat top. . .  
 Studious Jim Timson. . .  
 Baseball Playing Jerry Lattimore. . .  
 Pretty Pat Krimsky. . .  
 Pete Matousek's resemblance to Elvis. . .  
 Al Heltman's drum. . .  
 Donna Hogg's tiny feet. . .  
 Bob Zinkand's last place in the alphabet. . .  
 Barb Mihalick's skating ability. . .  
 Alberta Bohnert's pretty clothes. . .  
 Ron Destro and Joan Maljaric. . .  
 Tall Elmer Crosier. . .  
 Margaret Ducsay's nickname--"Dolly"  
 Eddie Brott on the basketball court. . .  
 Quiet (?) Gordon Caudill. . .  
 Friendly Dick Cox. . .  
 Gaynol Crocker's LENS salesmanship. . .  
 Hal Hendershot's kiss for the Queen. . .  
 Carol Lauten's ability in dramatics. . .  
 Head songbirds, Ginny Stewart and Jim Sabel. . .  
 Judy Rogers' school spirit. . .  
 Dan Kennedy's prowess in physics. . .  
 Phyllis Patterson's 4. average. . .  
 Carolyn Blazy's dancing ability. . .  
 Jane Buchner's explosive combination of freckles and giggles. . .  
 Quiet 'n' nice, Ida Egleston. . .  
 Greg Fox's winning way. . .  
 Bob Gongas' mild manner. . .  
 Karl Gross' German accent. . .  
 Micheala Hiebert's newness to WHS. . .  
 Jim Heltman's sports stories. . .  
 John Stange's gentleness. . .  
 Marilyn Oberdank's cute hair. . .  
 Marie O'Donnell's smiling face. . .  
 Gerald Plescher's all-aroundness. . .  
 Arlee Reynold's humor. . .  
 Bill Prindle and Ron Prygo!. . .  
 Jean Hull's daintiness. . .  
 Pat Frazier's attractiveness. . .  
 Betsy Crego's sense of humor. . .  
 Bernadine Colagross' lovely personality. . .  
 Louise Cecelic's sentimentality. . .  
 Elaine Chesnes' fairness. . .

BUILD THEE MORE STATELY MANSIONS, O MY SOUL,  
AS THE SWIFT SEASONS ROLL!  
LEAVE THY LOW-VAULTED PAST!  
LET EACH NEW TEMPLE, NOBLER THAN THE LAST,  
SHUT THEE FROM HEAVEN WITH A DOME MORE VAST,  
TILL THOU AT LENGTH ART FREE,  
LEAVING THINE OUTGROWN SHELL BY LIFE'S UNRESTING SEA!

Oliver Wendell Holmes

# COMING ATTRactions

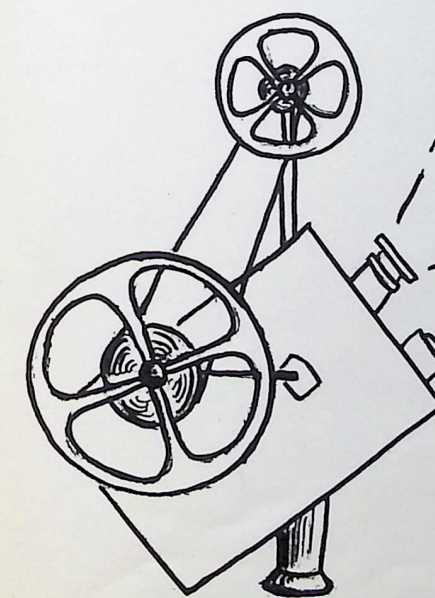

# UNDERCLAS

BUILD THEE MORE STATELY MANSIONS, O MY SOUL,  
AS THE SWIFT SEASONS ROLL!  
LEAVE THY LOW-VAULTED PAST!  
LET EACH NEW TEMPLE, NOBLER THAN THE LAST,  
SHUT THEE FROM HEAVEN WITH A DOME MORE VAST,  
TILL THOU AT LENGTH ART FREE,  
LEAVING THINE OUTGROWN SHELL BY LIFE'S UNRESTING SEA!

Oliver Wendell Holmes

# COMING ATTRACTIONS

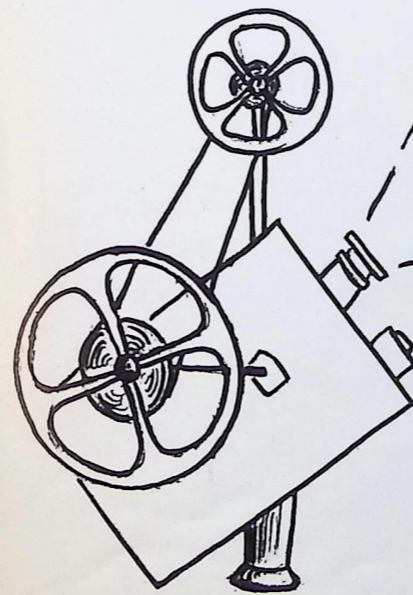

# UNDERCLASSMEN

# LADDER OF SUCCESS



JUNIOR CLASS OFFICERS

Tom June, Pres., Burton Schwartz, V-P., Irene Germ, Sec., Betty Book, Treas.



## JUNIOR COUNCIL

W. Tring, J. Gasier, C. Cox, T. Gubanc, L. Kennelly, L. Purola, W. Makowski.

# CLASS OF 1958

The juniors, already secure on the Willoughby scholastic ladder recall in brief many of the highlights that made this year at the high school a memorable one.

The Junior Class Dance, held in April, was probably the outstanding feature of the social year. To obtain money for this affair, the juniors gave a square dance, held a tax-stamp drive, and sponsored a dance.

The leader of this busy group was Tom June. Assisting him was Burton Schwartz, vice-president. Busily keeping minutes was class secretary, Irene Germ. Class treasurer, Betty Book, kept the class well in the black.

These students are looking forward to next year when they will be **THE SENIORS.**

1  
9  
5  
8



J. Ackroyd L. Adams S. Alexander A. Alpeter A. Angus C. Baisch K. Barbian T. Beal  
B. Adams G. Ahard B. Allen D. Anderson J. Antonacci T. Baller J. Barbic P. Blake



L. Conley



M. Collins



D. Collins



D. Cola

J. Cochran M. Cigler D. Christian J. Carroll J. Campbell S. Cagle G. Butzer B. Bullock  
E. Coker B. Clappas P. Cianfaglione T. Cassidy C. Carrillo D. Camp R. Caesar J. Burch



1  
9  
5  
8

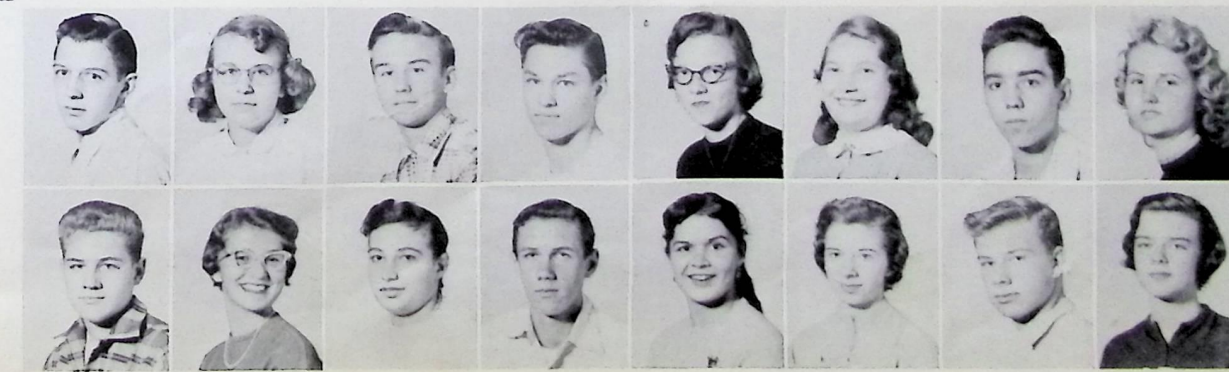



**JUNIOR COUNCIL**

W. Tring, J. Gasier, C. Cox, T. Gubanc, L. Kennelly, L. Purola, W. Makowski.

**CLASS OF 1958**

The juniors, already secure on the Willoughby scholastic ladder recall in brief many of the highlights that made this year at the high school a memorable one.

The Junior Class Dance, held in April, was probably the outstanding feature of the social year. To obtain money for this affair, the juniors gave a square dance, held a tax-stamp drive, and sponsored a dance.

The leader of this busy group was Tom June. Assisting him was Burton Schwartz, vice-president. Busily keeping minutes was class secretary, Irene Germ. Class treasurer, Betty Book, kept the class well in the black.

These students are looking forward to next year when they will be **THE SENIORS.**

Irene Germ, Sec., Betty Book, Treas.

1  
9  
5  
8



J. Ackroyd L. Adams S. Alexander A. Alpeter A. Angus C. Baisch K. Barbian T. Beal A. Bogun C. Bole B. Book  
B. Adams G. Ahard B. Allen D. Anderson J. Antonacci T. Baller J. Barbic P. Blake K. Bohnsack D. Bond C. Bradley

L. Conley



M. Collins



D. Collins



D. Cola



J. Cochran M. Cigler D. Christian J. Carroll J. Campbell S. Cagle G. Butzer B. Bullock J. Buby J. Brumagin E. Brott  
E. Coker B. Clappas P. Cianfaglioner T. Cassidy C. Carrillo D. Camp R. Caesar J. Burch J. Buchner J. Brunetz N. Brown



C. Brettrager



R. Brezic



M. Britton



1  
9  
5  
8

1  
9  
5  
8

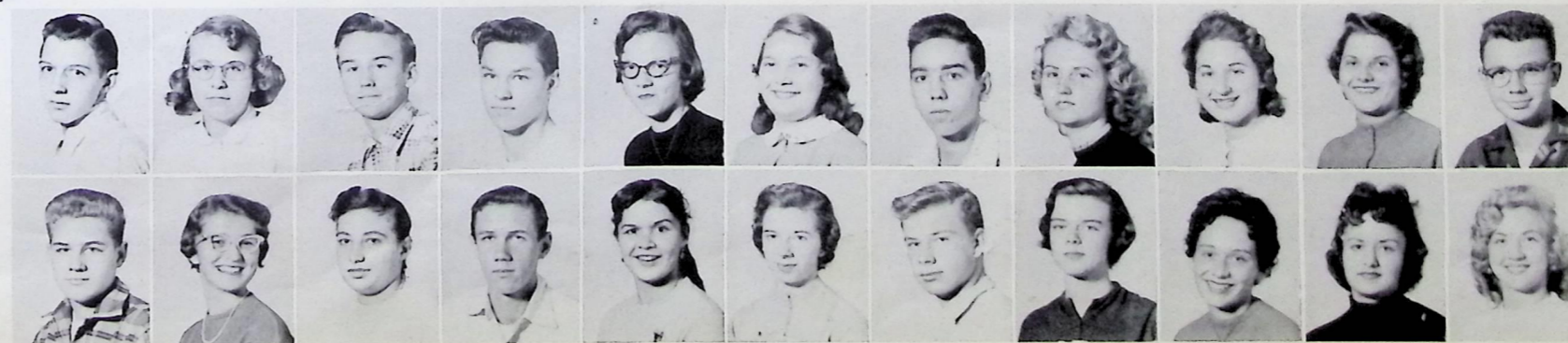

1  
9  
5  
8

1958



M. Corlew C. Cox M. Crookham D. Cullen J. Cullitan J. Cunningham M. DelCarpini R. Derrick N. DiCello D. Dickinson H. Dietz G. Dirrman D. Dinday G. Dorman G. Dskocil B. Doyle D. Drener R. Dusi B. Eichler C. Estes D. Evans C. Faflik



T. Gubanc



C. Gruss



T. Gruelle



G. Grose

H. Greenaway P. Grieger B. Goetz G. Gant R. Gibson M. Ginerva J. Gerbic I. Germ D. Geosano T. Gerald J. Gasier T. Geary S. Furnas M. Futchi B. Fulton W. Fulton R. Francis D. Frank K. Finnegan G. Fischer J. Fickes T. Field



1958

1958



S. Faller



D. Fargo



M. Federico



T. Ferrick

1958

1958



D. Haag M. Halck G. Hambrecht S. Hamilton A. Hamko D. Hammer R. Hansen J. Hare B. Hartsough C. Hartung J. Harwood E. Hunko G. Hunger E. Higgenbotham K. Hofman B. Hoge



J. Lewis



M. LeRoy



B. Lear



D. Lawson

C. LaVerne B. Lawler J. Lasko B. Larick K. Kron J. Landman C. Koutnik C. Kramer J. Kovacik P. Kovacik G. Kokotec D. Konro R. Klingensmith J. Klimas C. King R. Klein



1958





litan  
ningham M. DelCarpini R. Derrick N. DiCello D. Dickinson H. Dietz G. Dirrman D. Dinday G. Dorman G. Duskocil B. Doyle D. Drener R. Dusi B. Eichler C. Estes D. Evans C. Faflik

1  
9  
5  
8



S. Faller



D. Fargo



M. Federico



T. Ferrick



ibson  
nerva J. Gerbic I. Germ D. Geosano T. Gerald J. Gasier T. Geary S. Furnas M. Futchi B. Fulton W. Fulton R. Francis D. Frank K. Finnegan G. Fischer J. Fickes T. Field

1  
9  
5  
8



1  
9  
5  
8



D. Haag M. Halck G. Hambrecht S. Hamilton A. Hamko D. Hammer R. Hansen J. Hare B. Hartsough C. Hartung J. Harwood E. Hunko G. Hunger E. Higgenbotham K. Hofman B. Hoge P. Hogg A. Hughes D. Humphrey D. Isle L. Jafelice B. Janis

1  
9  
5  
8



J. Lewis



M. LeRoy



B. Lear



D. Lawson

C. LaVerne B. Lawler J. Lasko B. Larick K. Kron J. Landman C. Koutnik C. Kramer J. Kovacic P. Kovacic G. Koketec D. Konro R. Klingensmith J. Klimas C. King R. Klein L. Kennelly A. King R. Kalmar J. Kennedy D. Justice R. Kaczynski

1  
9  
5  
8



1  
9  
5  
8



B. Jeray



D. Jordan



M. Jordan



T. June



1958



A. Lillick J. Ling F. Little R. Little D. LoConti C. Lonsway M. Lucas P. Mahoney B. Majersik W. Makowski D. Marsh T. Mathias A. Mauceri R. McCauley M. McIntosh M. McMichael B. Mellen B. Meyers C. Meyers D. Michiner A. Miller B. Miller

J. Pollard



G. Poling



R. Pizmohr



E. Pirkola



N. Pfeifle I. Pinter S. Petras J. Petrulis G. Perkins J. Peters K. Pearson M. Peoples J. Parent D. Patt B. Pach'n'ski L. Papes V. Olsen S. Ott L. Neeld N. Nichols B. Murray C. Murray J. Murs'ncav'g N. Murphy P. Moore M. Morris



1958



1958

M. Mills



R. Milner



M. Mohun



L. Montonari



1958



V. Potting H. Presley D. Preston K. Price D. Probst J. Pumphrey L. Purola D. Quinn D. Radebaugh C. Reed K. Reigle P. Reinhart E. Richter R. Rizer P. Roach B. Roberts

R. Spohn



B. Soul



J. Somadge



D. Snyder



J. Smith B. Snyder C. Smiley D. Smith J. Simoncic B. Smart S. Siers J. Semenak G. Showkeir J. Siefert C. Shenk K. Sherlock E. Sealey T. Setser R. Schwebel L. Schuping



1958







LoConti Lonsway M. Lucas P. Mahoney B. Majersik W. Makowski D. Marsh T. Mathias A. Mauceri R. McCauley M. McIntosh M. McMichael B. Mellen B. Meyers C. Meyers D. Michiner A. Miller B. Miller

1958



M. Mills



R. Milner



M. Mohun



L. Montonari



Perkins Peters K. Pearson M. Peoples J. Parent D. Patt B. Pach'n'ski L. Papes V. Olsen S. Ott L. Neeld N. Nichols B. Murray C. Murray J. Murs'nca'v'g N. Murphy P. Moore M. Morris



1958



V. Potting H. Presley D. Preston K. Price D. Probst J. Pumphrey L. Purola D. Quinn D. Radebaugh C. Reed K. Reigle P. Reinhart E. Richter R. Rizer P. Roach B. Roberts N. Ros'nb'rg'r S. Roszman A. Roth H. Rotman C. Rowland M. Ruckman

1958



R. Spohn



B. Soul



J. Somadge



D. Snyder



J. Smith B. Snyder C. Smiley D. Smith J. Simoncic B. Smart S. Siers J. Semenak G. Showkeir I. Siefert C. Shenk K. Sherlock E. Sealey T. Setser R. Schwebel L. Schuping H. Schneider B. Schwartz J. Schaerr J. Schmitz N. Said N. Saxe

P. Ruddick



E. Rushton



S. Russell



L. Saben



1958

1  
9  
5  
8



S. Stahl  
D. Stevenson  
L. Stiebig  
B. Stonner  
J. Strasser  
R. Sulzer  
T. Tanka  
B. Terry  
G. Thomas  
C. Thomas  
L. Thomas  
V. Thomas  
J. Thompson  
D. Tippen  
G. Tompson  
P. Tomsic  
W. Tring  
S. Varanof  
E. Vera  
B. Vest  
J. Vicario  
B. Virant

1  
9  
5  
8

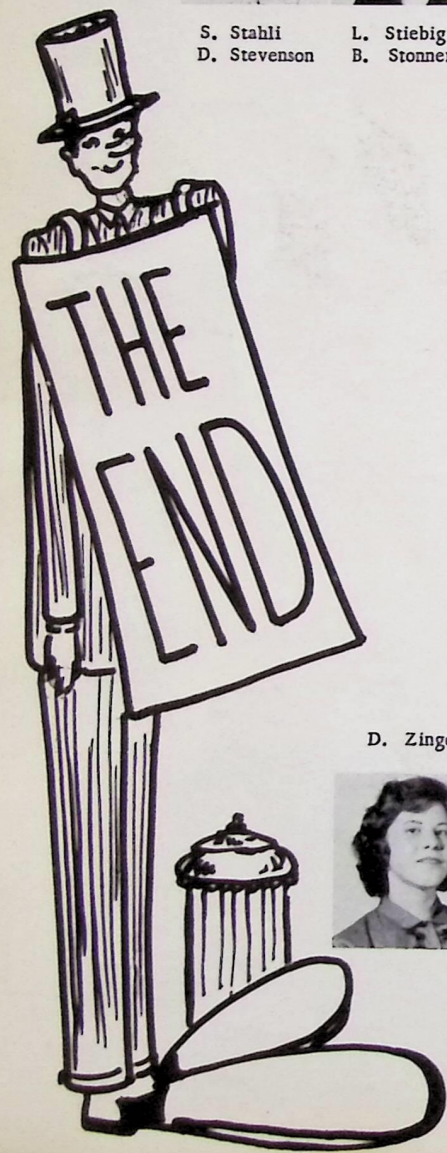

D. Zinger  
E. Zehe  
P. Zemple  
G. Young  
J. Yug  
P. Wolinski  
L. Wright  
D. Witt  
J. Winpis'g'r  
J. Williams  
G. Williamson  
A. Williams  
A. Williams  
D. Whinnery  
T. Whit'ngt'n  
B. Wenrick  
T. Wenz  
C. Waseleski  
J. Weber



1  
9  
5  
8

# LADDER OF SUCCESS



Sophomore

Seated: C. Crawford, N. Neubacher, H. L. J. Spoonamore, C. Taylor, P. Greer. Standing: D. Gogarn, W. Orloff, A. Lambo.

# CLAS

Here we have our underclassmen sitting at the bottom of our ladder for the junior class. Bob Bourquard is the president of the class is Louis Cicek. W. Dawn Harris. Evelyn Eby, treasurer of the Sophomore Dance, their biggest event is Patrick's Dance.

The sophomore officers and their class by Miss Marian Riemann,

Sophomore Class Officers

Bob Bourquard, president; Evelyn Eby, secretary; Louis Cicek, vice-president; Dawn Harris, treasurer.

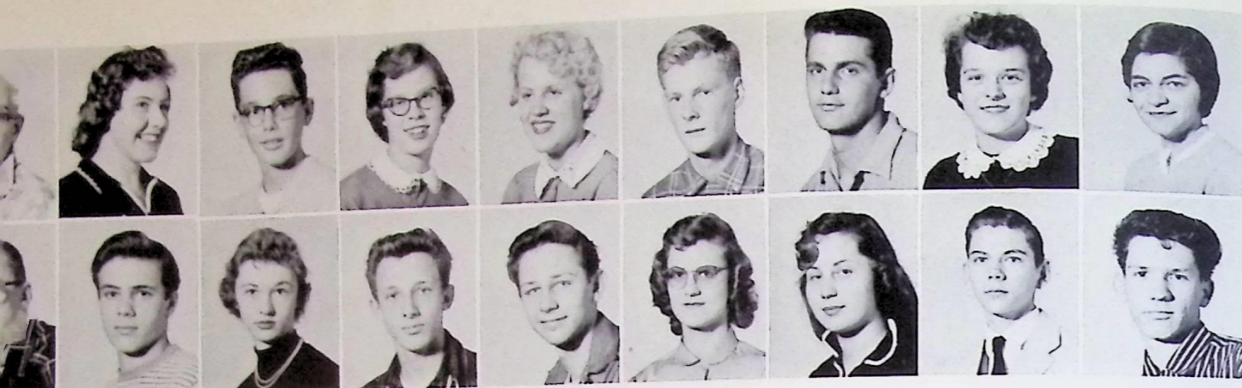

T. Tanka  
B. Terry

G. Thomas  
C. Thomas

L. Thomas  
V. Thomas

J. Thompson  
D. Tippen

G. Tompson  
P. Tomsic

W. Tring  
S. Varanof

E. Vera  
B. Vest

J. Vicario  
B. Virant

1  
9  
5  
8



G. Young  
J. Yug

P. Wolinski  
L. Wright

D. Witt  
J. Wimpis'gr

J. Williams  
G. Williamson

A. Williams  
A. Williams

D. Whinnery  
T. Whit'ngt'n

B. Wenrick  
T. Wenz

C. Waseleski  
J. Weber



1  
9  
5  
8

# LADDER OF SUCCESS



Sophomore Class Officers

Bob Bourquard, president; Evelyn Eby, secretary; Louis Cicek, vice-president; Dawn Harris, treasurer.

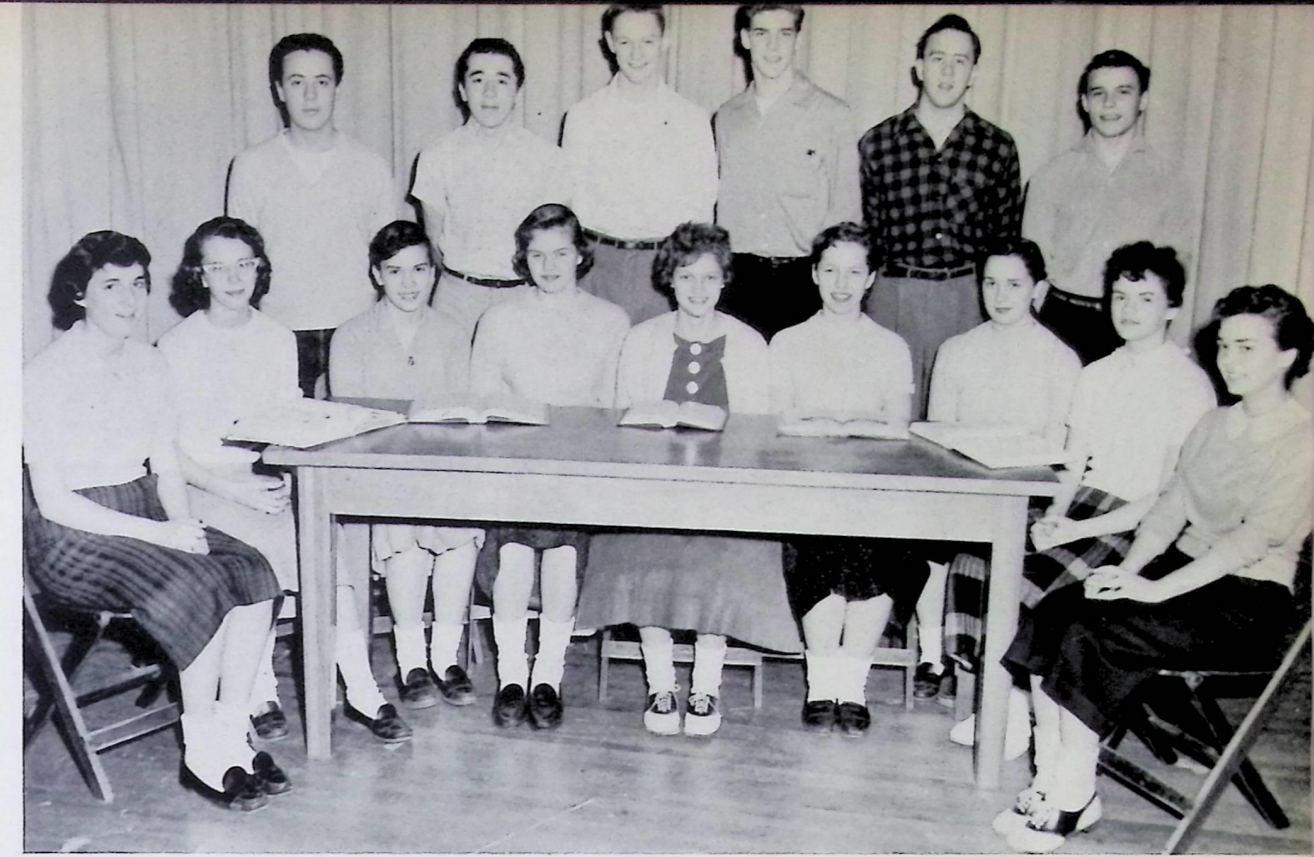

Sophomore Council

Seated: C. Crawford, N. Neubacher, H. Lohmeyer, A. Cooke, E. Huey, P. Petrovich, J. Spoonamore, C. Taylor, P. Greer. Standing: D. Atkin, E. Richards, B. Wendell, D. Gogarn, W. Orloff, A. Lambo.

# CLASS OF 1959

Here we have our underclassmen. They are still waiting patiently at the bottom of our ladder for the juniors to "scoot."

Bob Bourquard is the president of the anxious sophomores. Vice-president of the class is Louis Cicek. Writing the minutes of the class meetings is little Dawn Harris. Evelyn Eby, treasurer, is busily counting money made on the Sophomore Dance, their biggest project. The sophomores also had a St. Patrick's Dance.

The sophomore officers and council are aided in the management of the class by Miss Marian Riemann, class advisor.

1  
9  
5  
9



1  
9  
5  
9



E. Adams  
C. Allman

R. Anderson  
J. Angellucci

M. Arnold  
F. Arthur

D. Atkin  
R. Bacon

H. Bailey  
V. Baker

A. Barbean  
J. Barker

J. Barna  
G. Barr

V. Barr  
V. Barrett

L. Bartko  
R. Bartoszek

S. Baughman  
A. Baum

S. Beam  
P. Bechbe

B. Burch



G. Bunke



P. Bundy



B. Bultman

J. Bukovec  
G. Bullock

S. Buerk  
J. Buhl

C. Brunecz  
C. Buerk

A. Brunecz

M. Brassell  
D. Brisbane

F. Boytz  
W. Brady

D. Bousquet  
S. Boyle

J. Bohnsack  
R. Bourquard

B. Blazer  
R. Blumel

W. Bishop  
R. Blake

J. Bilski  
C. Bishop

1  
9  
5  
9



1  
9  
5  
9



1  
9  
5  
9



T. Burgess  
B. Burke

G. Burke  
J. Burke

K. Cahill  
J. Carter

D. Case  
P. Cedervall

L. Cicek  
W. Clasen

P. Clementson  
L. Code

C. Cofferty  
J. Colle

T. Collins  
J. Conley

E. Fedor



A. Farley



H. Fairbanks



G. Evans



B. Edwards  
E. Eichler

E. Eby  
A. Edgell

J. Ducsay  
V. Dunlap

B. Downs  
P. Drot

R. Doughe  
B. Downing

M. Disbro  
V. Dodds

D. Dewald  
J. Dickson

A. Dannes  
B. Davis



1  
9  
5  
9

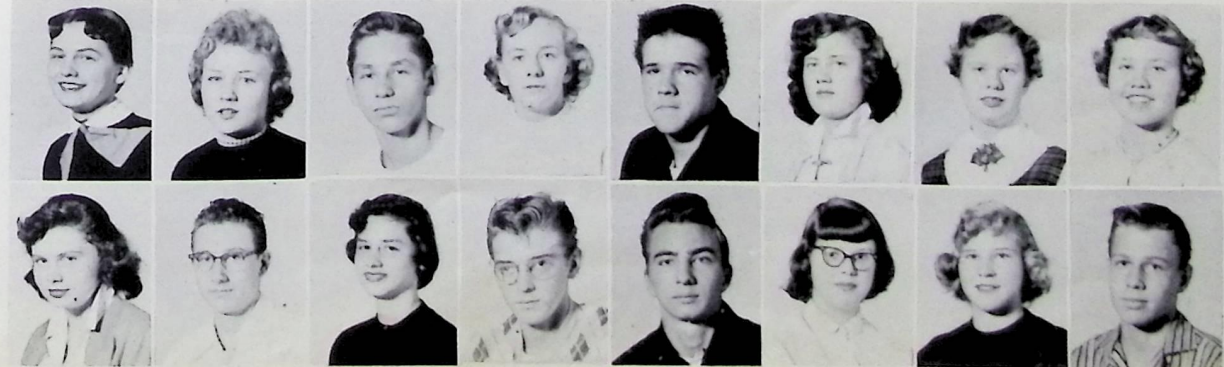

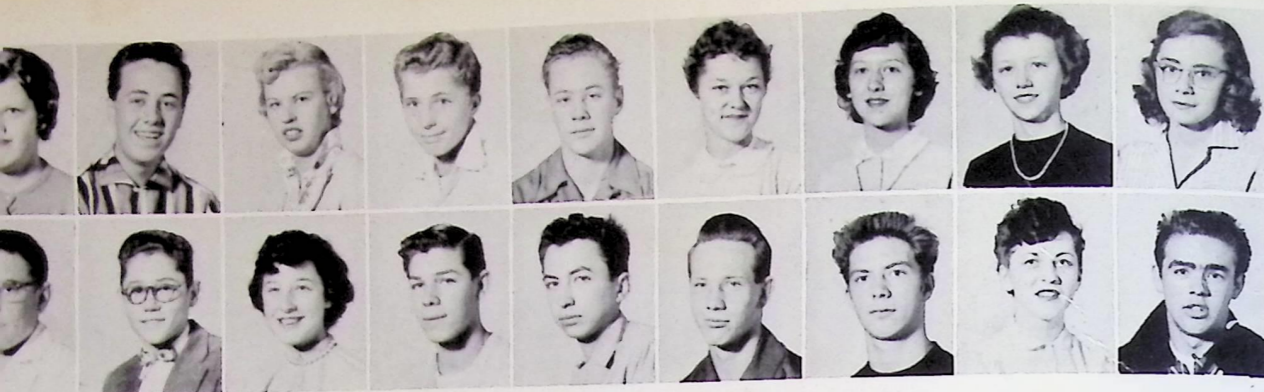

1959

Arnold  
Arthur  
D. Atkin  
R. Bacon  
H. Bailey  
V. Baker  
A. Barbean  
J. Barker  
J. Barna  
G. Barr  
V. Barr  
V. Barrett  
L. Bartko  
R. Bartoszek  
S. Baughman  
A. Baum  
S. Beam  
P. Bechbe

B. Beck



J. Bejger



J. Bell



B. Berndt



Brunez  
A. Brunez  
M. Brassell  
D. Brisbine  
F. Boytz  
W. Brady  
D. Bousquet  
S. Boyle  
J. Bohnsack  
R. Bourquard  
B. Blazer  
R. Blumel  
W. Bishop  
R. Blake  
J. Bilski  
C. Bishop



1959

1959



1959

T. Burgess  
B. Burke  
G. Burke  
J. Burke  
K. Cahill  
J. Carter  
D. Case  
P. Cedervall  
L. Cicek  
W. Clasen  
P. Clementson  
L. Code  
C. Cofferty  
J. Colle  
T. Collins  
J. Conley  
J. Connell  
J. Cook  
J. Cook  
A. Cooke  
A. Cooke  
J. Cooke  
A. Costello

E. Fedor



A. Farley



H. Fairbanks



G. Evans



B. Edwards  
E. Eichler  
E. Eby  
A. Edgell  
J. Ducsay  
V. Dunlap  
B. Downs  
P. Drot  
R. Doughe  
B. Downing  
M. Disbro  
V. Dodds  
D. Dewald  
J. Dickson  
A. Dannes  
B. Davis  
J. Currie  
D. Daniels  
B. Cratty  
C. Crawford  
R. Cox  
H. Crandal

E. Coughlin



G. Counts



C. Coward



B. Cox



1959



1959

1959



D. Fevold S. Flack B. Foster M. Foster J. Foutz J. Francis J. Freeman T. Frye J. Gano S. Gates J. Gielink  
S. Fevold S. Forrester J. Foster M. Foster K. Frances G. Freck B. Futchi J. Gaag C. Gaskins \*D. Geraghty J. Gielink



H. Hayford



M. Hayes



D. Hartman



G. Harris

J. Hardgrove M. Harbath J. Hammond B. Hamilton L. Hager R. Habina D. Haagen J. Grover K. Gregory M. Green R. Grable  
D. Harris R. Harber A. Hann R. Hamilton R. Hamilton S. Hacker R. Haak M. Gubanc H. Gross P. Greer E. Grall

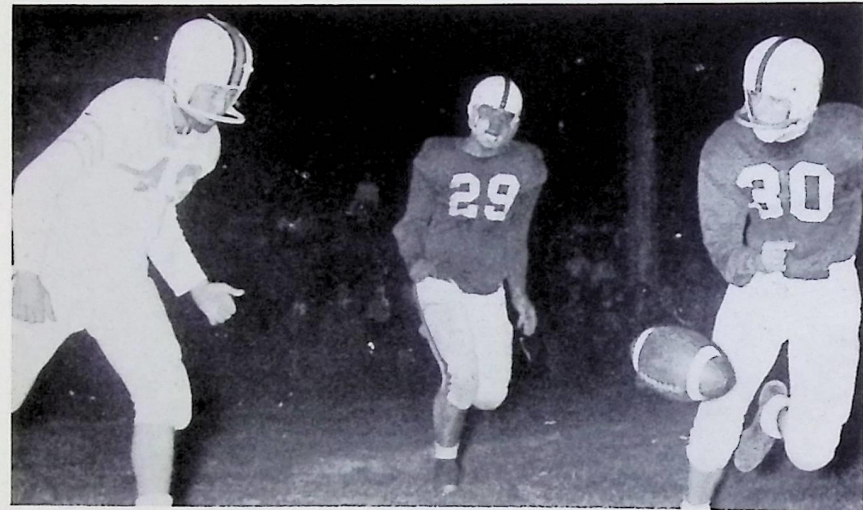

1959



1959

1959

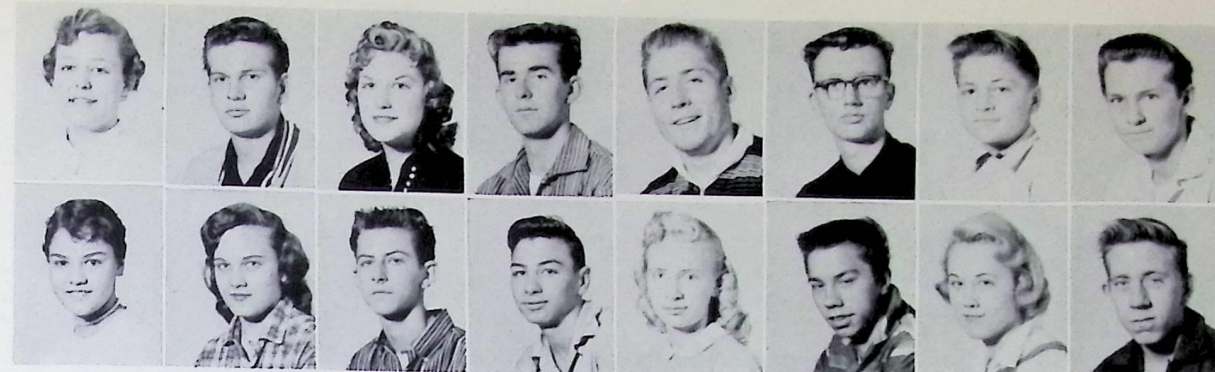

S. Helber N. Henning J. Herbert W. Himes J. Hoban R. Hobby J. Hoge T. Holub  
A. Henderson R. Henwood L. Hickman J. Hipsher S. Hobbs L. Hoffman L. Hohnsbein C. Howard



S. Gill



F. Gladstone



D. Gogam



J. Gould



J. Lanning



R. Langer



S. Lampe



A. Lambo



S. Kushlan K. Kuntz J. Kovarik P. Koster G. Klemm F. Kidner D. Kenyeres K. Keeler  
E. Kustic C. Kurtz M. Kuhn M. Kovacic M. Konad J. Klein D. Keyerleber A. Kenyeres

1959



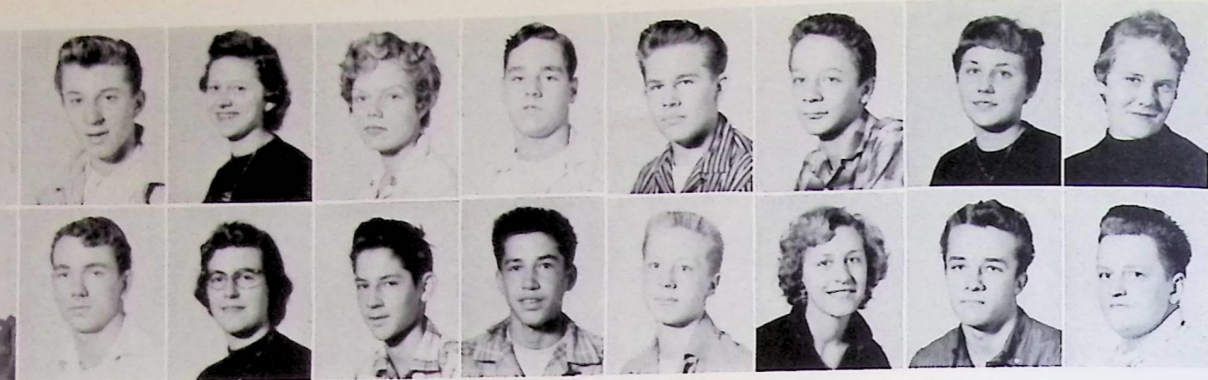

M. Foster  
M. Foster

J. Foutz  
K. Frances

J. Francis  
G. Freck

J. Freeman  
B. Futchi

T. Frye  
J. Gaag

J. Gano  
C. Gaskins

S. Gates  
D. Geraghty

J. Gielink  
J. Gielink



B. Hamilton  
R. Hamilton

L. Hager  
R. Hamilton

R. Habina  
S. Hacker

D. Haagen  
R. Haak

J. Grover  
M. Gubanc

K. Gregory  
H. Gross

M. Green  
P. Greer

R. Grable  
E. Grall



1  
9  
5  
9



S. Gill

F. Gladstone

D. Gogam

J. Gould

1  
9  
5  
9

1  
9  
5  
9



S. Helber  
A. Henderson

N. Henning  
R. Henwood

J. Herbert  
L. Hickman

W. Himes  
J. Hipsher

J. Hoban  
S. Hobbs

R. Hobby  
L. Hoffman

J. Hoge  
L. Hohnsbein

T. Holub  
C. Howard

S. Howiler  
E. Huey

J. Hunt  
J. Isherwood

G. Janke  
J. Jarmusch



J. Lanning

R. Langer

S. Lampe

A. Lambo



S. Kushlan  
E. Kustic

K. Kuntz  
C. Kurtz

J. Kovarik  
M. Kuhn

P. Koster  
M. Kovacic

G. Klemm  
M. Konad

F. Kidner  
J. Klein

D. Kenyeres  
D. Keyerleber

K. Keeler  
A. Kenyeres

C. Kaluga  
B. Kapferer

J. Jordan  
J. Jordan

B. Jonke  
B. Jordan

1  
9  
5  
9



J. Johannes

L. Johnston

R. Jones

R. Jones

1  
9  
5  
9



1  
9  
5  
9



J. Lattimore E. Lawlon C. Lekan B. Lenz T. Lino T. Loar T. Longhitans R. Loven N. Luke E. McCartney B. Mance  
L. Laughlin H. Lehtonen B. Lemin W. Linden D. Little H. Lohmeyer L. Loughlin S. Lukas J. Lyons J. Mack N. Manta

T. Morgan

P. Moon

N. Mook

M. Moody

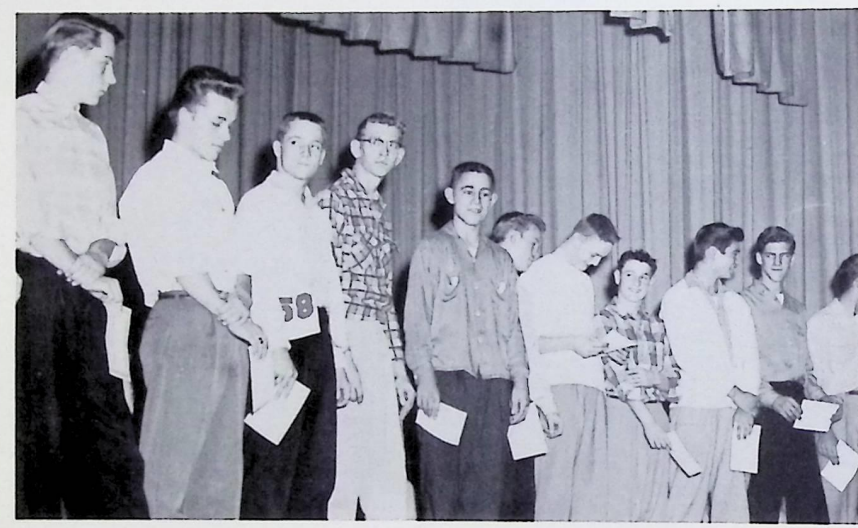

R. Minear P. Miller G. Miller F. Metsung N. Meares L. McNaughton G. McMullen A. McKay J. McCuen B. McCauley S. Matyevak  
C. Molly R. Miller J. Miller D. Miller D. Megginson J. McNea P. McNamara P. McLaughlin K. McIntosh N. McCauley R. McAndrews

1  
9  
5  
9

1  
9  
5  
9



K. Morgillo C. Mucha J. Murdoch J. Nash N. Neubacher R. Norsell B. Novak N. Olson  
D. Motulewicz S. Muman J. Murton B. Neiner M. Normandy E. Noss B. Olesko W. Orloff

M. Rice

L. Rhodds

C. Rettig

L. Reichert



J. Rasmussen E. Ramsey J. Pulford G. Prosser J. Price T. Pollar A. Porter P. Phillips  
D. Reardon A. Ramski B. Raab J. Ptak J. Price C. Price L. Preston J. Popson

1  
9  
5  
9



1  
9  
5  
9

1  
9  
5  
9







1  
9  
5  
9

B. Lenz  
W. Linden  
T. Lino  
D. Little  
T. Loar  
H. Lohmeyer  
T. Loughitans  
L. Loughlin  
R. Loven  
S. Lukas  
N. Luke  
J. Lyons  
E. MacCartney  
J. Mack  
B. Mance  
N. Manta



L. Marhoefer



G. Marsh



F. Martich



T. Mastin



F. Metsung  
D. Miller  
N. Meares  
D. Megginson  
L. McNaughton  
J. McNea  
G. McMullen  
P. McNamara  
A. McKay  
P. McLaughlin  
J. McCuen  
K. McIntosh  
B. McCauley  
N. McCauley  
S. Matyevak  
R. McAndrews



1  
9  
5  
9

1  
9  
5  
9



K. Morgillo  
D. Motulewicz  
C. Mucha  
S. Muman  
J. Murdoch  
J. Murton  
J. Nash  
B. Neiner  
N. Neubacher  
M. Normandy  
R. Norsell  
E. Noss  
B. Novak  
B. Olesko  
N. Olson  
W. Orloff  
K. Ostrow  
C. Pacholka  
M. Paciorek  
D. Palmer  
D. Papineau  
B. Papes

M. Rice



L. Rhodds



C. Rettig



L. Reichert



J. Rasmussen  
D. Reardon  
E. Ramsey  
A. Ramski  
J. Pulford  
B. Raab  
G. Prosser  
J. Ptak  
J. Price  
J. Price  
T. Pollar  
C. Price  
A. Porter  
L. Preston  
P. Phillips  
J. Popson  
J. Pettit  
B. Phifer  
J. Peterson  
P. Petrovic  
D. Pepin  
P. Perkins



J. Parinish



H. Parks



J. Peci



F. Penley



1  
9  
5  
9

1  
9  
5  
9

1959



W. Rice P. Riddle E. Richards C. Richert W. Rose L. Ross B. Rotman E. Rugnetta H. Russell S. Sacchini T. Sakach L. Saler D. Sargent D. Saxe L. Saxe M. Schmitz G. Schnigder J. Schriener B. Schultz D. Schulz K. Schwebel E. Seaber



D. Sulecki



L. Summers



L. Stolar



B. Stark

B. Spring A. Stafanick J. Spotton B. Sprague M. Spence J. Spoonamore T. Sparre B. Spate J. Sohl J. Southworth B. Snetsinger B. Snyder B. Smith B. Smith J. Skinner I. Sluga C. Singer D. Skinner P. Shriner S. Siddons S. Shannon W. Shaw

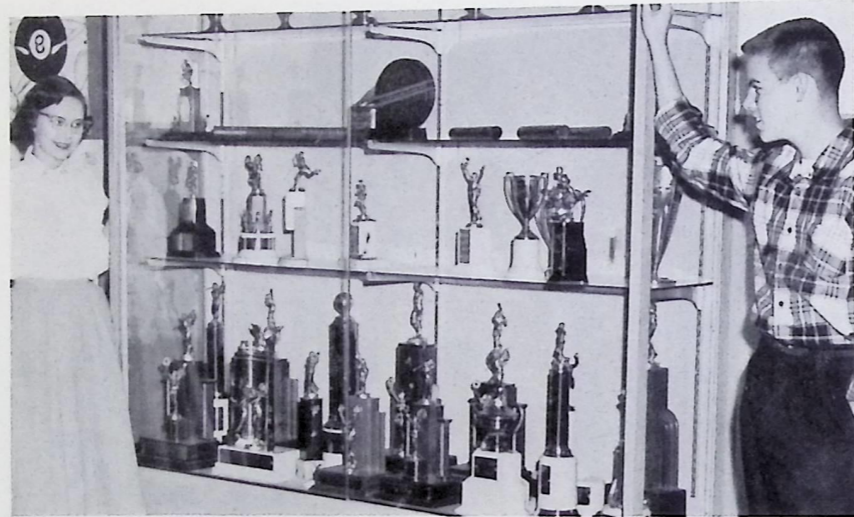

1959

1959



R. Sweeney B. Szatkowski E. Tate B. Taylor C. Taylor M. Taylor B. Thames L. Thomas R. Thomas B. Trawatha L. Trivisono S. Tuthill G. Tuttle D. Unger D. Valentino P. Valore



D. Sealey



E. Sears



J. Sears



G. Sellers

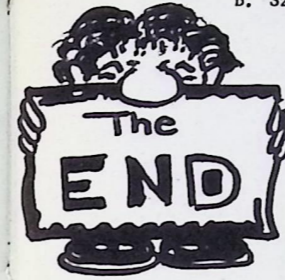

G. Zirm



R. Young

B. Yappel G. Yerse I. Wood J. Wooley A. Wolkensdorfer D. Wollschleger B. Wilson V. Witt L. Whitner J. William R. Wesfall L. Whinnery B. Wendell F. Werner B. Weiss E. Welker



1959



1959

1959





B. Rotman H. Russell T. Sakach D. Sargent L. Saxe G. Schnigder B. Schultz K. Schwebel  
E. Rugnetta S. Sacchini L. Saler D. Saxe M. Schmitz J. Schriner D. Schulz E. Seaber

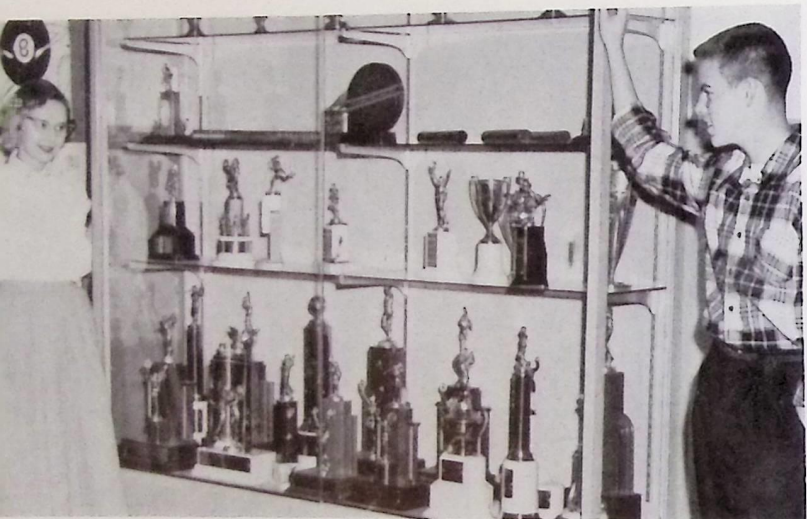

D. Sealey



E. Sears



J. Sears



G. Sellers



T. Sparre J. Sohl B. Snetsinger B. Smith J. Skinner C. Singer P. Shriner S. Shannon  
B. Spate J. Southworth B. Snyder B. Smith I. Sluga D. Skinner S. Siddons W. Shaw



1959

1959



R. Sweeney E. Tate C. Taylor B. Thames R. Thomas L. Trivisano G. Tuttle D. Valentino J. Vaughn L. Vernier D. Viol  
B. Szatkowski B. Taylor M. Taylor L. Thomas B. Trawatha S. Tuthill D. Unger P. Valore K. Verbecky E. Videtic B. Virant

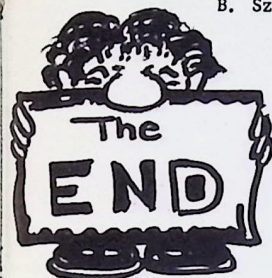

G. Zirm



R. Young



D. Vlach



D. Wade



M. Wales



P. Walker



B. Yappel I. Wood A. Wolkensdorfer B. Wilson L. Whitner R. Wesfall B. Wendell B. Weiss N. Weimer B. Webber R. Walther  
G. Yerse J. Wooley D. Wollschleger V. Witt J. William L. Whinnery F. Werner E. Welker F. Weingand B. Weber L. Walter



1959

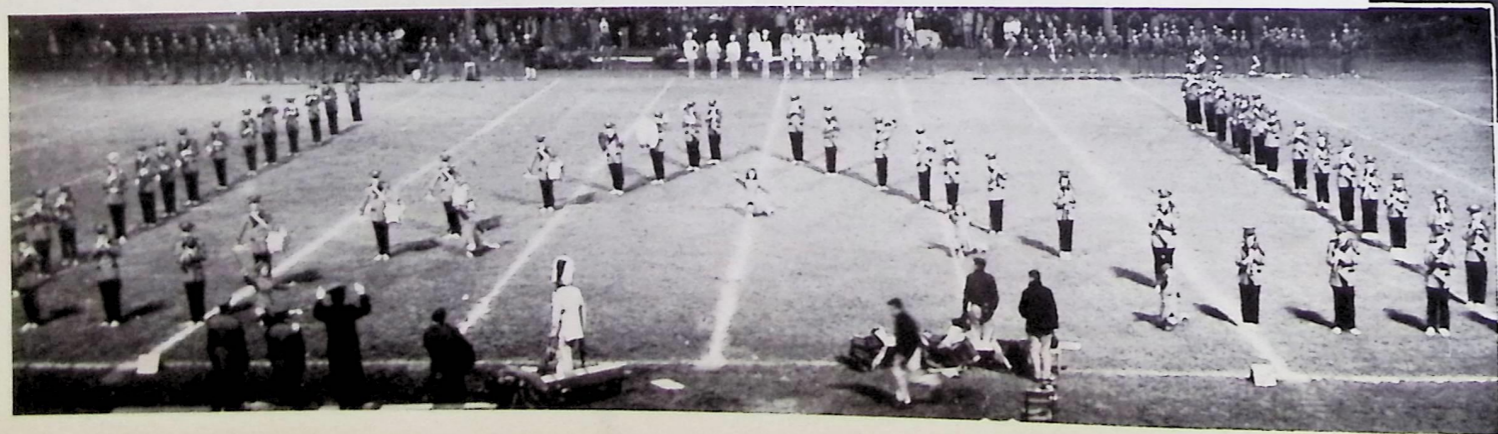

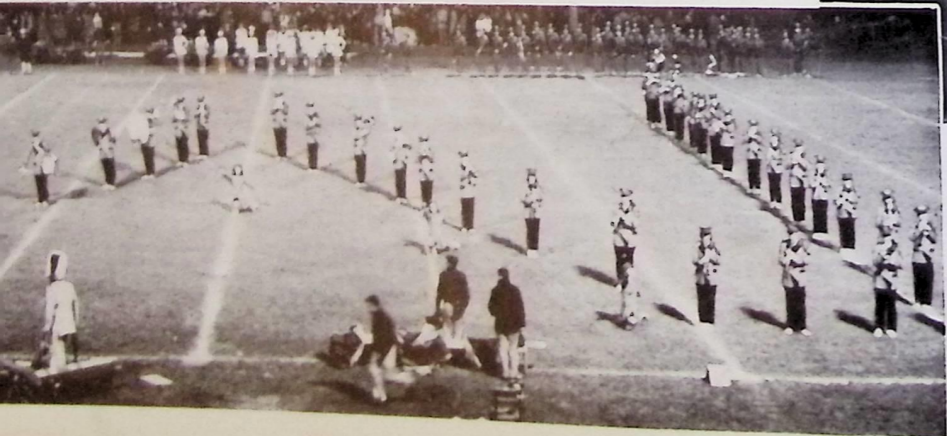



First Row: N. Williams, V. Tyler, G. York, P. Patterson, J. Rogers, C. Bouton, N. Lippens, S. Hengst. Second Row: R. McLean, R. Widgren, J. Nelson, J. Stendel, A. Shaw, K. Wright, A. Alpeter, R. Doyle. Third Row: R. Wendell, R. Mullen.

# LENS STAFF

Putting out a year book is not an easy job. There are pictures to be taken, articles to be written, and always, a dead-line to be met. While the members of the staff are working on these things, the salesmen are doing their best to sell the books.

Editor, Phyllis Patterson, and advisor, Mr. James Smeed, saw to it that all jobs were completed. Mr. Richard Miller was in charge of the Lens salesmen.

Even though it was hard work and often discouraging, we had a lot of good times and were really thrilled when the book started to take form.

J. Smeed, Advisor.

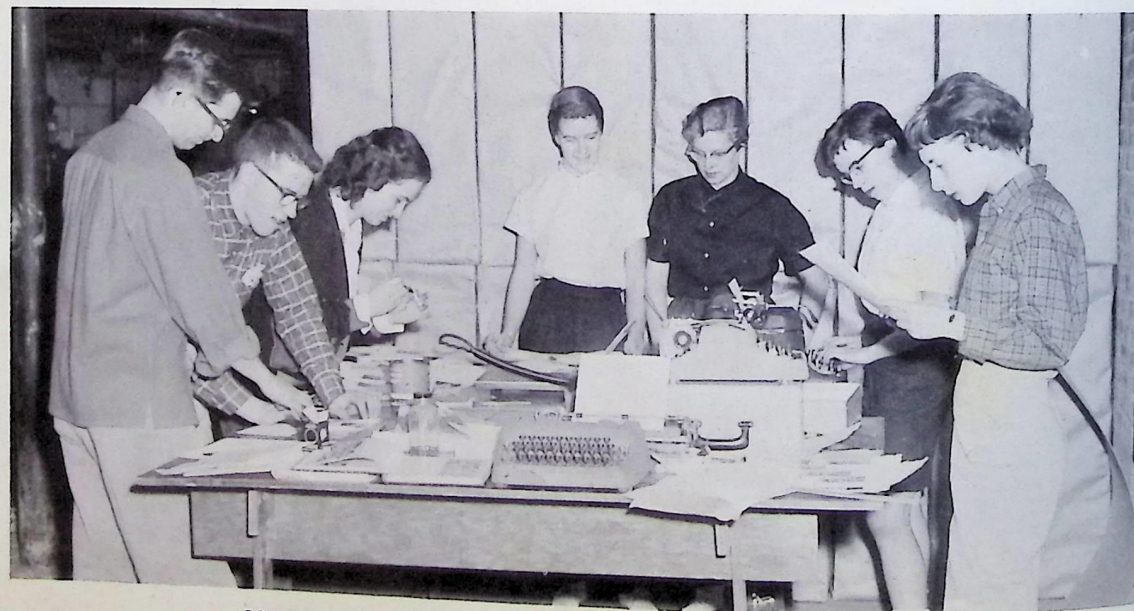
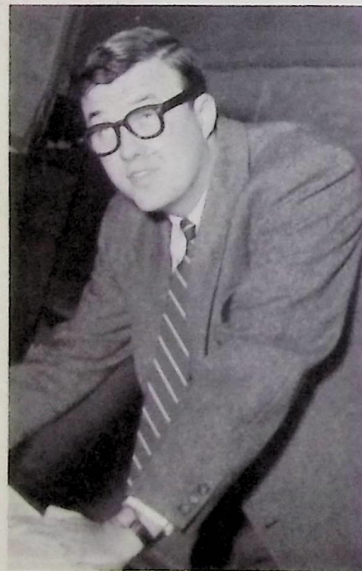

# LENS SA

First Row: L. Donovan, J. Alexander, C. Bomgardner, S. Fedor, P. Boykin, S. Gidley, B. Halaburda, G. Bell. Second Row: J. Dixon, D. Ducsay, B. Dickson, C. Schriener, B. Mitrovich, A. Bailey, R. Litwiler, M. Weaver. Third Row: R. Morgan, M. Harris, D. Waiter, J. Stone, P. Clark, S. Estes, S. Rose, G. Stewart. Fourth Row: E. Fertig, R. Jackson, F. Chisholm, L. Herold, M. Mestrovich, D. Parmele, G. Crocker, S. Teple.

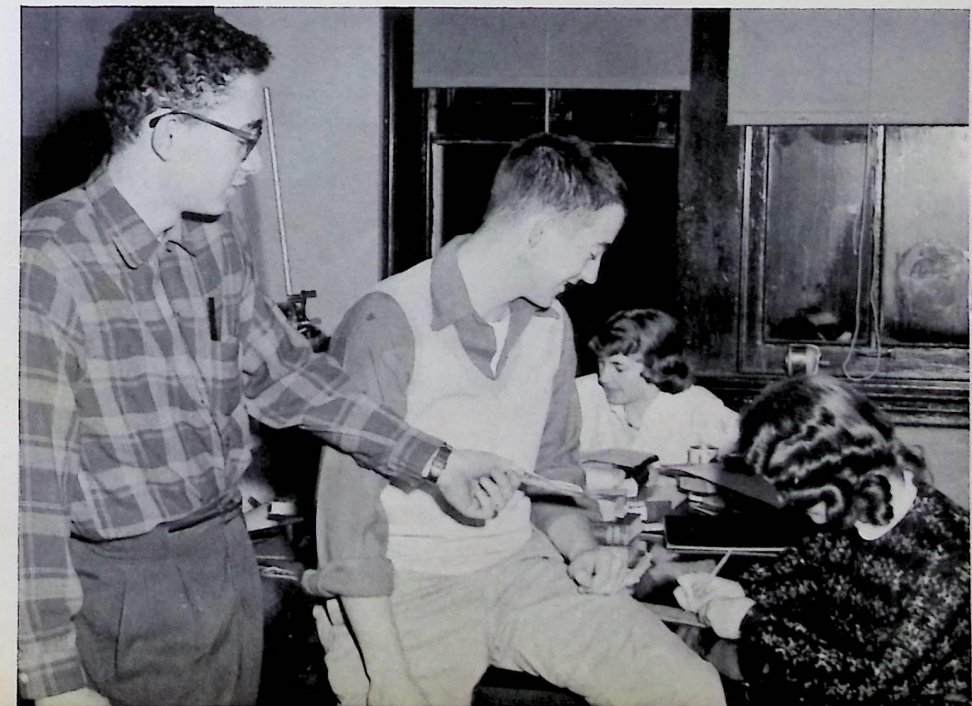
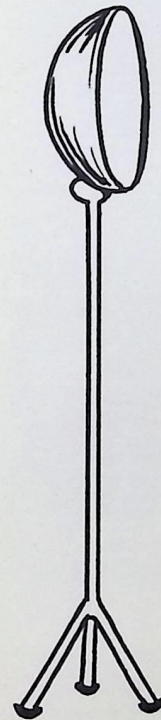



# LENS STAFF

Putting out a year book is not an easy job. There are pictures to be taken, articles to be written, and always, a dead-line to be met. While the members of the staff are working on these things, the salesmen are doing their best to sell the books.

Editor, Phyllis Patterson, and advisor, Mr. James Smeed, saw to it that all jobs were completed. Mr. Richard Miller was in charge of the Lens salesmen.

Even though it was hard work and often discouraging, we had a lot of good times and were really thrilled when the book started to take form.

York, P. Patterson, J. Rogers, C. Bouton, N. Lippens, S. Hengst. Second row, J. Stendel, A. Shaw, K. Wright, A. Alpeter, R. Doyle. Third Row:

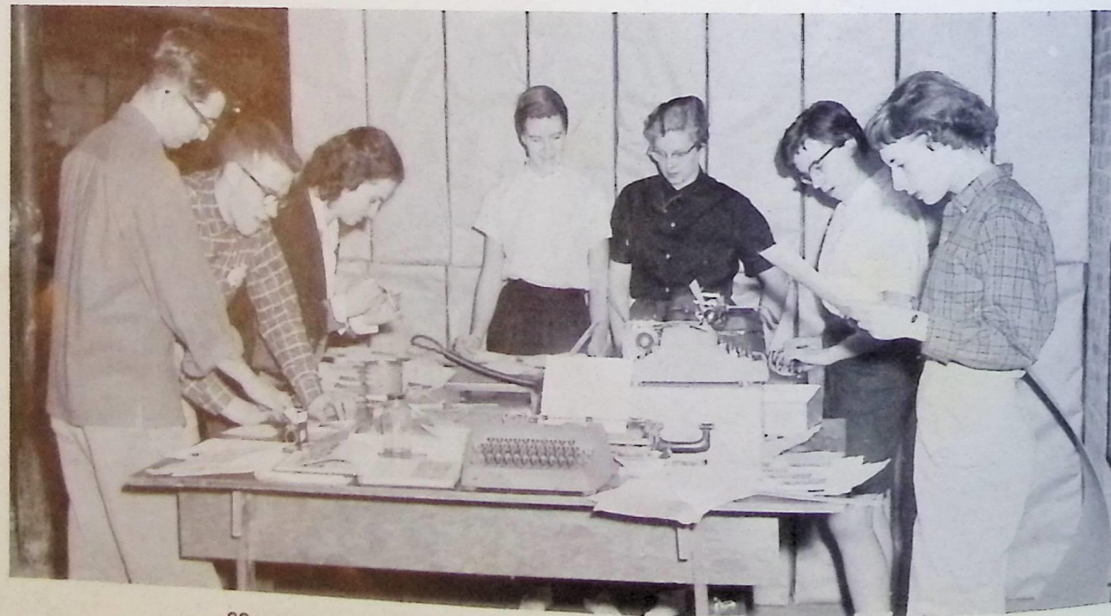

First Row: L. Donovan, J. Alexander, C. Bomgardner, S. Fedor, P. Boykin, S. Gidley, B. Halaburda, G. Bell. Second Row: J. Dixon, D. Ducsay, B. Dickson, C. Schriener, B. Mitrovich, A. Bailey, R. Litwiler, M. Weaver. Third Row: R. Morgan, M. Harris, D. Waite, J. Stone, P. Clark, S. Estes, S. Rose, G. Stewart. Fourth Row: E. Fertig, R. Jackson, F. Chisholm, L. Herold, M. Mestrovich, D. Parmele, G. Crocker, S. Teple.

# LENS SALESMEN

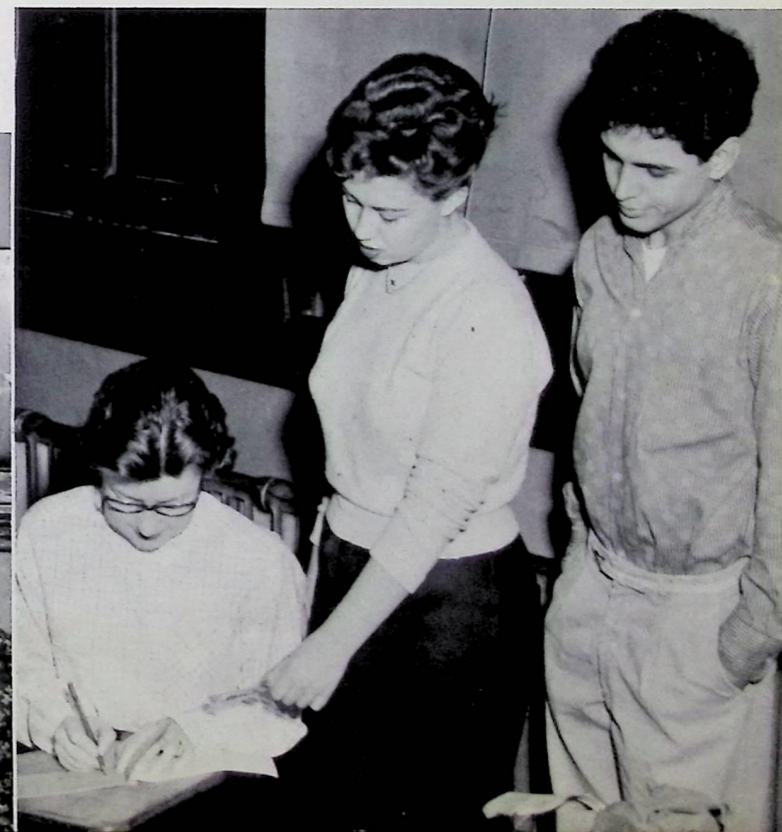
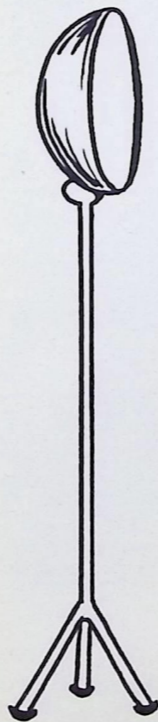

# STUDENT COUNCIL



## REPRESENTATIVES

First Row: S. Estes, J. Brumagin, M. Weaver, J. Murdock, A. Foutz, P. Greer, J. Cole. Second Row: M. Corlew, N. Williams, D. Atkins, L. Thomas, S. Richards, G. Stewart, S. Stahli, D. Lawson. Third Row: K. Lohmeyer, S. Siers, A. Cooke, G. Croker, D. Waite, J. Orick, J. Cullitan, G. Perkins. Fourth Row: B. Gongas, B. Wendell, R. Klein, R. Francis, D. Kennedy, F. Martich, B. Snyder, R. Sweeney.



First Row: J. Rogers, J. Rauker, B. Doyle, A. Alpeter. Second Row: T. Gieling, K. Wright, R. Mullen, S. Farran, J. Gasier, N. Lippens, D. Pelz, P. Patterson.



Mr. A. S. Holloway, Advisor.

The purpose of the Student Council is to stimulate the desire in every student to become a first class citizen and to inspire the student body to work together. This year, the tremendous school spirit built up before the Mentor game during School Spirit Week was a good example of the fine work of this important organization. The sale of toothbrushes and decals to help furnish the student lounge of North High was another big Student Council project. The Homecoming Dance, the talent show, and many after game dances were sponsored by the group.

This year's officers are Jim Rauker, president; Bob Doyle, vice president; Judy Rogers, secretary; and Ann Alpeter, treasurer. Mr. Arthur Holloway is the club advisor.



## ALTERNATES

First Row: H. Lohmeyer, M. Collins, A. Wolkersdorfer, B. Halaburta, B. Book, D. Harris. Second Row: A. McKay, G. Daskocil, B. Mitrovich, B. Meyers, P. Mericle, L. Maitland. Third Row: V. Dodds, R. Jackson, G. Cooke, M. Ginevra, J. Smith, E. Smith, L. Hager. Fourth Row: B. Swartz, L. Cicek, R. Cox, D. Daniels, P. Russo, R. Herrick, B. Wendell.

# NATIONAL HONOR SOCIETY



H. Lake, Advisor.



D. Kennedy, J. Rogers, P. Patterson, K. Wright, R. Lang, C. Blazy, A. Bailey, R. McLean, S. Farren, S. Parks, C. Bouton, R. Needham, D. Hogg.

The National Honor Society is a group of students who are selected for scholarship, and the group's main purpose is to help members.

The officers are Judy Rogers, vice president and Lang, secretary.

The co-advisors are Miss Lake and Miss Matz.

First Row: Gidley, S. Second Row: Stahlhut, R. Teple, A. man, C. C. kowski, D. Matz.





# STUDENT COUNCIL

## REPRESENTATIVES

First Row: S. Estes, J. Brumagin, M. Weaver, J. Murdock, A. Foutz, P. Greer, J. Cole. Second Row: M. Corlew, N. Williams, D. Atkins, L. Thomas, S. Richards, G. Stewart, S. Stahl, D. Lawson. Third Row: K. Lohmeyer, S. Siers, A. Cooke, G. Croker, D. Waite, J. Orick, J. Cullitan, G. Perkins. Fourth Row: B. Gongas, B. Wendell, R. Klein, R. Francis, D. Kennedy, F. Martich, B. Snyder, R. Sweeney.



A. Alpeter. Second Row: n, J. Gaster, N. Lippens,



## ALTERNATES

First Row: H. Lohmeyer, M. Collins, A. Wolkersdorfer, B. Halaburta, B. Book, D. Harris. Second Row: A. McKay, G. Daskocil, B. Mitrovich, B. Meyers, P. Mericle, L. Maitland. Third Row: V. Dodds, R. Jackson, G. Cooke, M. Ginevra, J. Smith, E. Smith, L. Hager. Fourth Row: B. Swartz, L. Cicek, R. Cox, D. Daniels, P. Russo, R. Herrick, B. Wendell.

The purpose of the Student Council is to stimulate the desire in every student to become a first class citizen and to inspire the student body to work together. This year, the tremendous school spirit built up before the Mentor game during School Spirit Week was a good example of the fine work of this important organization. The sale of toothbrushes and decals to help furnish the student lounge of North High was another big Student Council project. The Homecoming Dance, the talent show, and many after game dances were sponsored by the group.

This year's officers are Jim Rauker, president; Bob Doyle, vice president; Judy Rogers, secretary; and Ann Alpeter, treasurer. Mr. Arthur Holloway is the club advisor.



H. Lake, Advisor.

# NATIONAL HONOR SOCIETY



The National Honor Society is an organization of students who have been recognized for outstanding scholarship, character, leadership, and service. The group's main function is its annual induction ceremony for juniors and seniors who have been selected as members.

The officers are: Dan Kennedy, president; Ronnie Lang, vice president; Phyllis Patterson, secretary; Judy Rogers, treasurer.

The co-advisors of the society are Mr. Herbert Lake and Miss Margaret Gibbs.

D. Kennedy, J. Rogers, P. Patterson, K. Wright, R. Lang, C. Blazy, A. Bailey, R. McLean, S. Farren, S. Parks, C. Bouton, R. Needham, D. Hogg.

First Row: L. Donovan, M. Weaver, G. York, A. Shaw, S. Gidley, S. Rose, J. Nelson, J. Stone, N. Lippens, V. Tyler. Second Row: R. Litwiler, N. Dey, R. Roberts, D. Waite, C. Stahlhut, R. Brezic, L. Buhl, B. Schultz, J. Heltman, S. Teple, A. Huston. Third Row: D. Pelz, J. Ackroyd, H. Rotman, C. Cox, B. Schwartz, W. Fulton, G. Butzer, W. Makowski, D. Brezic, A. Alpeter, L. Purola, P. Ruddick, J. Matz.





First Row: J. Ackroyd, M. Weaver, V. Tyler, S. Farran, C. Blazy, D. Waite, S. Parks, P. Hadley, S. Gidley.  
 Second Row: P. Ruddick, J. Rogers, P. Patterson, A. Shaw, R. Litwiler, A. Bailey, J. Petrulis, D. Dickinson,  
 H. Rotman. Third Row: J. Stone, C. Bouton, C. Stahlhut, J. Nelson, S. Rose, M. McIntosh, L. Purola, C.  
 Cox. Fourth Row: K. Wright, J. Lewis, P. Zemple, J. Burch, D. Anderson, J. Perusek, R. Roberts, N. Wil-  
 liams, K. Paranish. Fifth Row: R. Brezic, D. Pelz, D. Kennedy, B. McLean, L. Goldrick, R. Brezic, W. Ma-  
 kowski, G. Butzer.

# SCHOLARSHIP CLUB

One of the largest organizations in school, the Scholarship Club encourages the regular and faithful performance of academic work.

The Club's officers are: Carolyn Blazy, Pres., Susan Parks, V.P., Donna Waite, Sec., Vicky Tyler, Treas.

Sally Farran was Vice President of the county organization which held its annual dinner dance in October.



First Row: S. Siddons, B. Thamer, S. Gill, J. Colle, A. McKay, B. Rotman, D. Wollschleger, L. Saler.  
 Second Row: P. Cedervalle, J. Bejgar, J. Dickson, H. Lohmeyer, P. Koster, B. Weber, J. Mack, P. Mil-  
 ler. Third Row: D. Wade, J. Nash, S. Saccini, M. Volcansek, I. Wood, D. Dewald, S. Baughman, K.  
 Cahill. Fourth Row: J. Bokovic, B. Taylor, D. Hartman, D. Kenyeres, A. Kenyeres, G. Evans, C. Sing-  
 er, P. Petrovich, M. Harbath. Fifth Row: T. Moore, D. Megginson, J. Hardgrove, J. Gano, B. Bourgard,  
 B. Hamilton, D. Skinner, J. Phifer, D. Bousquet.



W.M.P.W. Banquet



M. Gibbs, Advisor



W.M.P.W. Banquet



First Row: J. Ackroyd, M. Weaver, V. Tyler, S. Farran, C. Blazy, D. Waite, S. Parks, P. Hadley, S. Gidley.  
 Second Row: P. Ruddick, J. Rogers, P. Patterson, A. Shaw, R. Litwiler, A. Bailey, J. Petrulis, D. Dickinson,  
 Rotman. Third Row: J. Stone, C. Bouton, C. Stahlhut, J. Nelson, S. Rose, M. McIntosh, L. Purola, C.  
 Fourth Row: K. Wright, J. Lewis, P. Zemple, J. Burch, D. Anderson, J. Perusek, R. Roberts, N. Wil-  
 Fifth Row: R. Brezic, D. Pelz, D. Kennedy, B. McLean, L. Goldrick, R. Brezic, W. Ma-  
 wski, G. Butzer.

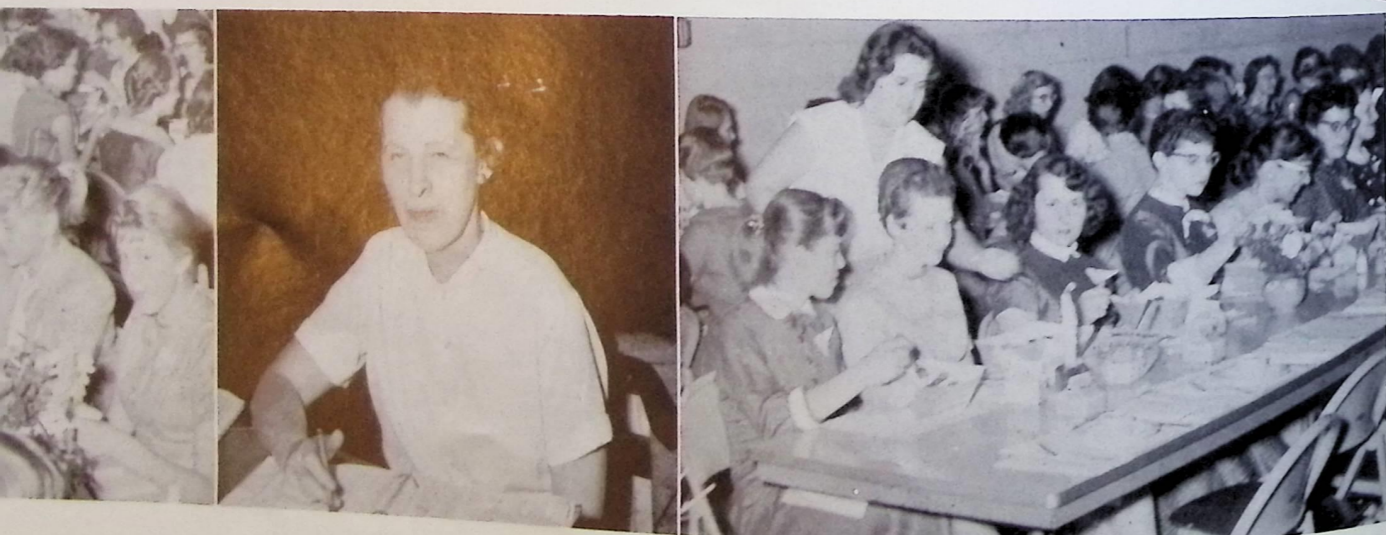

M. Gibbs, Advisor

W.M.P.W. Banquet

# SCHOLARSHIP CLUB

One of the largest organizations in school, the Scholarship Club encourages the regular and faithful performance of academic work.

The Club's officers are: Carolyn Blazy, Pres., Susan Parks, V.P., Donna Waite, Sec., Vicky Tyler, Treas.

Sally Farran was Vice President of the county organization which held its annual dinner dance in October.



First Row: S. Siddons, B. Thamer, S. Gill, J. Colle, A. McKay, B. Rotman, D. Wollschleger, L. Saler.  
 Second Row: P. Cedervalle, J. Bejgar, J. Dickson, H. Lohmeyer, P. Koster, B. Weber, J. Mack, P. Miller.  
 Third Row: D. Wade, J. Nash, S. Saccini, M. Volcansek, I. Wood, D. Dewald, S. Baughman, K. Cahill.  
 Fourth Row: J. Bokovic, B. Taylor, D. Hartman, D. Kenyeres, A. Kenyeres, G. Evans, C. Singer, P. Petrovich, M. Harbath.  
 Fifth Row: T. Moore, D. Megginson, J. Hardgrove, J. Gano, B. Bourgard, B. Hamilton, D. Skinner, J. Phifer, D. Bousquet.

# CAMERA CLUB

First Row: J. Miller, E. Huey, P. Russo, R. McLean, P. Moon. Second Row: J. Angelucci, S. Teple, P. Blake, J. Stone, A. Allen. Third Row: C. Allman, N. Williams, G. Crocker, L. McNaughten, T. Beal. Fourth Row: T. Buhl, L. Neeld, W. Fulton, E. Brott, T. Burgess.

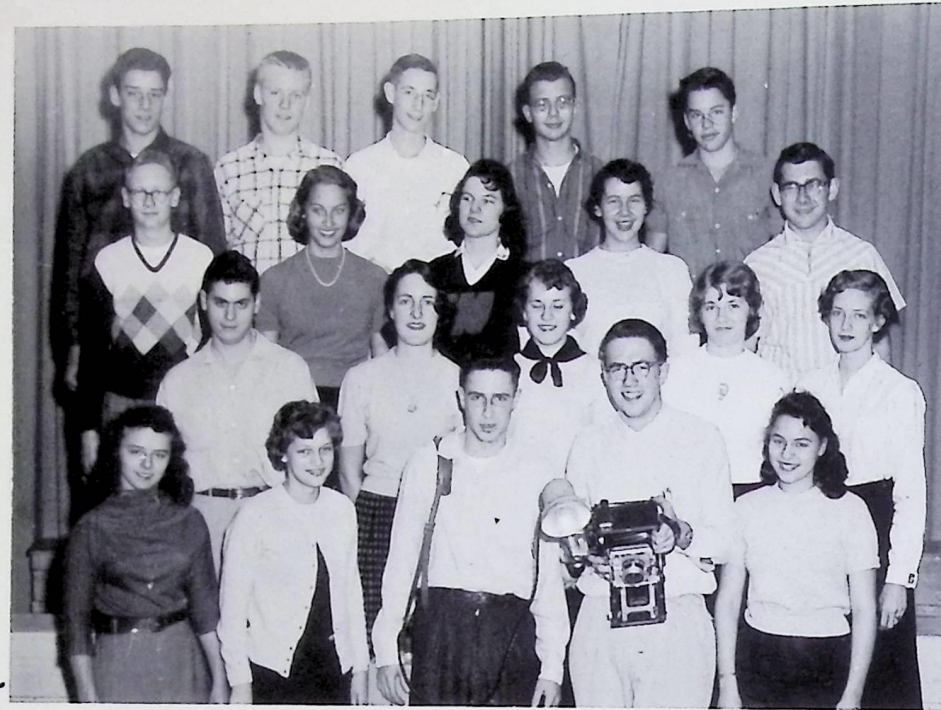

Under the supervision of Mr. D. J. Hewitt and Mr. D. Artale the Camera Club met bi-monthly to discuss techniques of photography and produce the many pictures needed for school publications.

The members of the club are very active all year and find enjoyment in taking, developing, and distributing photos.

The officers are: Bob McLean, president; Phil Russo, vice president; Eleanor Huey, secretary; Joanne Miller, treasurer; and Pat Moon, social chairman.

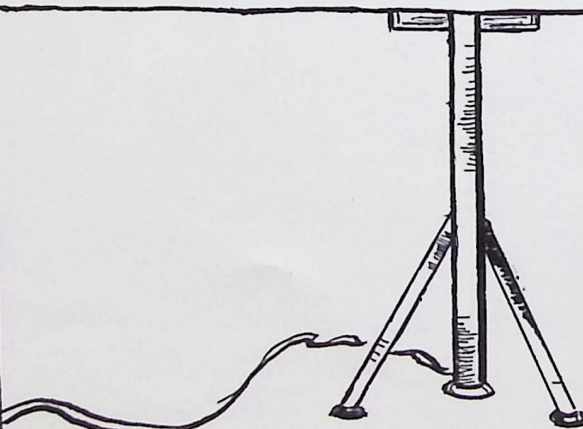
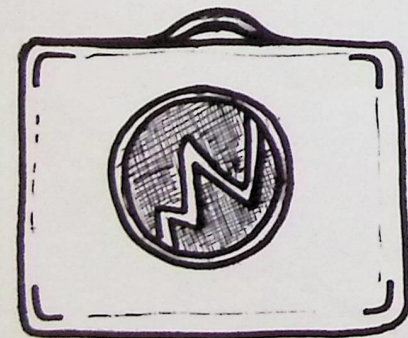

Bob McLean

D. Hewitt, Advisor

# \* Searchlight

Wednesday, June 5, 1957

## Sixteen Write '30' to Journal



## Students OK PULSE; Seek WHS Lifeblood

Sometime before the end of the academic year — probably in May — 'PULSE,' a general literary magazine written by WHS students, will make its first appearance. The new school publication, in the rumor mill for two years, was officially born last Thursday when students overwhelmingly indicated their support in a school-wide survey.

As early Monday machinery had already begun to grind to seek out talent and beat the publicity drums, and posters carrying the 'PULSE' message began making their appearance in the halls today.

Of the 716 students polled only 74 said they would not be in-

terested in the magazine at any cost. The balance indicated their approval, and 323 students even thought they would like to see the magazine oftener than once a semester.

### Finances a Problem

Because the soliciting of advertising as a means of raising

**S E A R**  
members shown to right, first Rosemary Jack, iams, Bob McL, Suzanne Heng, gardner, and Cy  
Second ro  
Robert Widgre  
Gaynor Crocker  
ey Tyler, Karen  
rey Balley.

operating reve  
aged, price was  
factors in the  
was feared that  
considered too  
the students p  
ever. The other  
price their app

# CAMERA CLUB

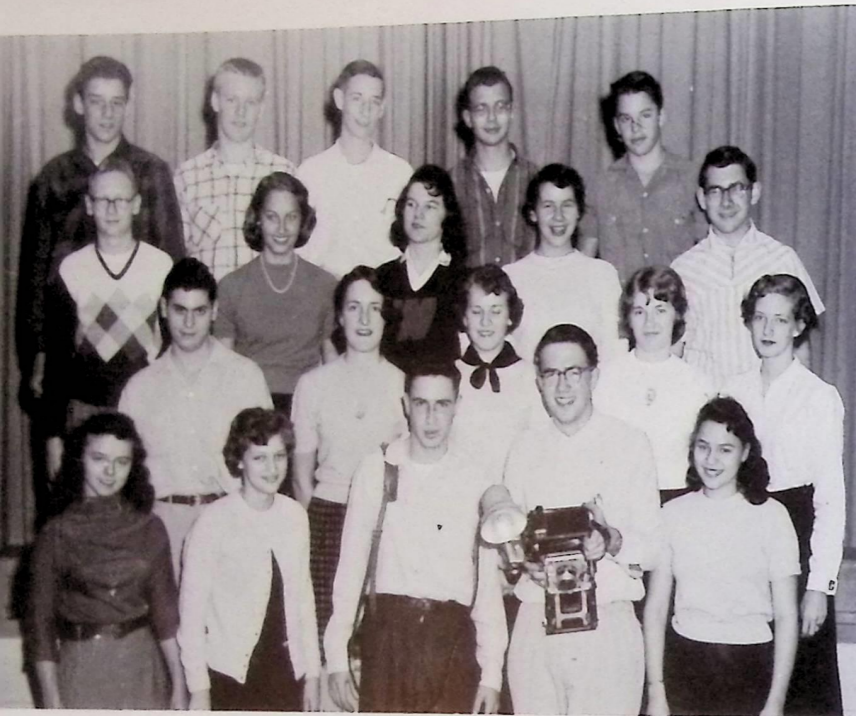

Under the supervision of Mr. D. J. Hewitt and Mr. D. Artale the Camera Club met bi-monthly to discuss techniques of photography and produce the many pictures needed for school publications.

The members of the club are very active all year and find enjoyment in taking, developing, and distributing photos.

The officers are: Bob McLean, president; Phil Russo, vice president; Eleanor Huey, secretary; Joanne Miller, treasurer; and Pat Moon, social chairman.

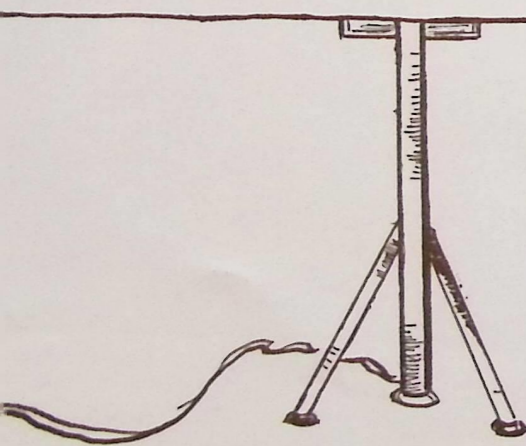

Bob McLean

D. Hewitt, Advisor

# \* Searchlight \*

Wednesday, June 5, 1957

Wednesday, June 5, 1957

## Sixteen Write '30' to Journalism Careers



### Cubs, Veterans Conclude Year's 'Searchlight'

Wednesday, June 5, WHS — Sixteen journalism II students today wrote the traditional "30" to the end of their 1956-57 newspaper careers. All but four bid final farewell to the SEARCHLIGHT.

The group published 34 Wednesday editions under the guidance of Mr. Leonard Slominski. Heading the student publication staff were editorial board members Sally Farran, Nancy Williams, and Bob McLean who rotated the individual responsibilities on a one-week-in-three basis.

Beginning the year as reporters were Carolyn Bomgardner, Gail York, Karen Wright, Cindy Bouton, Audrey Bailey, Donna Hogg, Linda Donovan, Gaynol Crocker, and Roberta Widgren. Sport writers Carolyn Blazy and Vickey Tyler and artist Suzanne Hengst were forced by combination of circumstances to retire from journalism at half year.

Cub reporters Hannah Rotman and Gloria Hambrecht, artist Mary Ginevra, and sports writer Gary Perkins joined the staff at the beginning of the second semester, having completed journalism I training.

### Students OK PULSE; Seek WHS Lifeblood

Sometime before the end of the academic year — probably in May — 'PULSE,' a general literary magazine written by WHS students, will make its first appearance. The new school publication, in the rumor mill for two years, was officially born last Thursday when students overwhelmingly indicated their support in a school-wide survey.

As early Monday machinery had already begun to grind to seek out talent and beat the publicity drums, and posters carrying the 'PULSE' message began making their appearance in the halls today.

Of the 716 students polled only 74 said they would not be in-

terested in the magazine at any cost. The balance indicated their approval, and 323 students even thought they would like to see the magazine oftener than once a semester.

#### Finances a Problem

Because the soliciting of advertising as a means of raising

SEARCHLIGHT members shown above are, left to right, first row: Gail York, Rosemary Jackson, Nancy Williams, Bob McLean, Sally Farran, Suzanne Hengst, Carolyn Bomgardner, and Cynthia Bouton.

Second row: Donna Hogg, Roberta Widgren, Linda Donovan, Gaynol Crocker, Judy Poe, Vickey Tyler, Karen Wright, and Audrey Bailey.

operating revenue was discouraged, price was one of the chief factors in the questionnaire. It was feared that 50 cents might be considered too high. Only 69 of the students polled balked, however. The others gave the proposed price their approval.



# THESPIANS



First Row: B. Halaburda, C. Bouton, R. Widgren, M. Weaver, G. York, D. Harris, G. Bell. Second Row: J. Alexander, J. Nelson, B. Dickson, C. Shriner, J. Rogers, R. Litwiler. Third Row: P. Patterson, N. Williams, S. Farran, K. Wright, L. Donovan, J. Stone, J. Dixon. Fourth Row: R. Mullen, R. Mominey, T. Prindle, R. Wendell, L. Buhl, R. Needham.

The purpose of this society is the advancement of standards of excellence in dramatic arts. The activities include a monthly meeting, senior class play, junior class play, and the Thespian one-acts.  
 This year Roberta Widgren headed the organization assisted by Gail York, V.P., Cindy Bouton, Sec., and Mona Weaver, Treas.

*Handwritten note:* Mrs. Moyer's class



N. Moyer, Advisor.



OSCULATION !

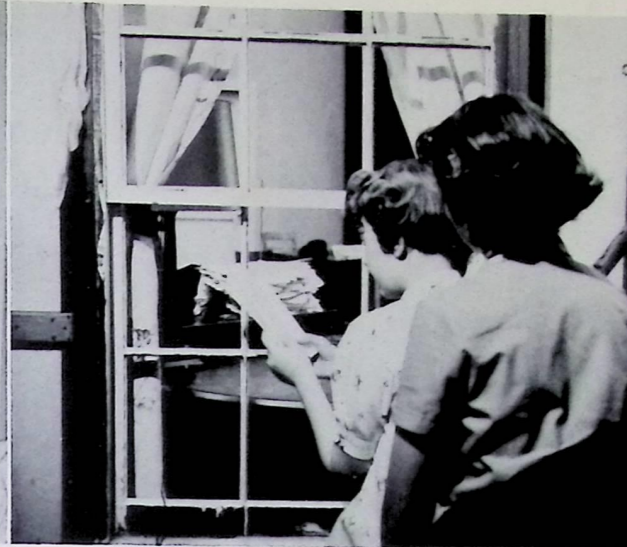

NO! THAT'S NOT YOUR LINE!



# JUNIOR SENIOR PLAY

WE SHOOK THE FAMILY TREE.

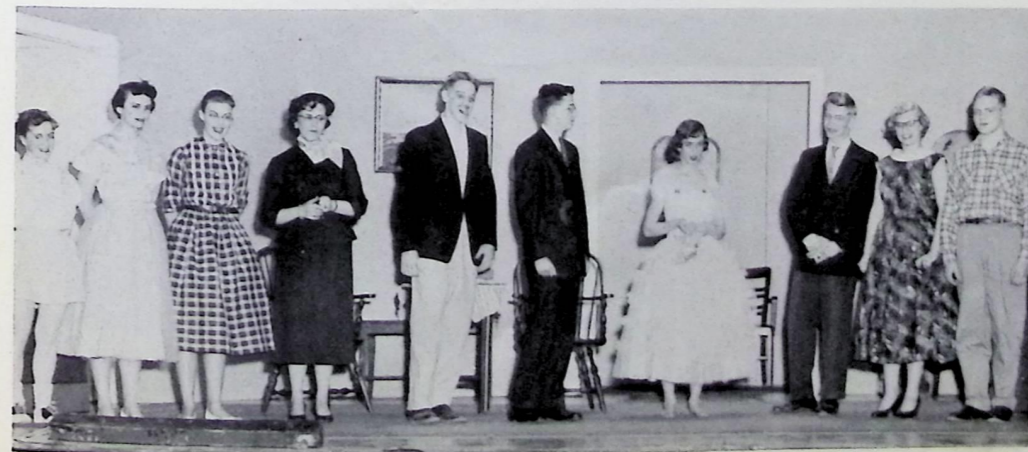

# HESPIANS



First Row: B. Halaburda, C. Bouton, R. Widgren, M. Weaver, G. York, D. Harris, G. Bell. Second Row: J. Alexander, J. Nelson, B. Dickson, C. Shriner, J. Rogers, R. Litwiler. Third Row: P. Patterson, N. Williams, S. Farran, K. Wright, L. Donovan, J. Stone, J. Dixon. Fourth Row: R. Mullen, R. Mominney, T. Prindle, R. Wendell, L. Buhl, R. Needham.

*Handwritten text in a vertical column, possibly a list of names or dates.*



N. Moyer, Advisor.



OSCULATION !



NO! THAT'S NOT YOUR LINE!



FATHER WAS A HOUSEWIFE.

# JUNIOR SENIOR PLAYS

WE SHOOK THE FAMILY TREE.

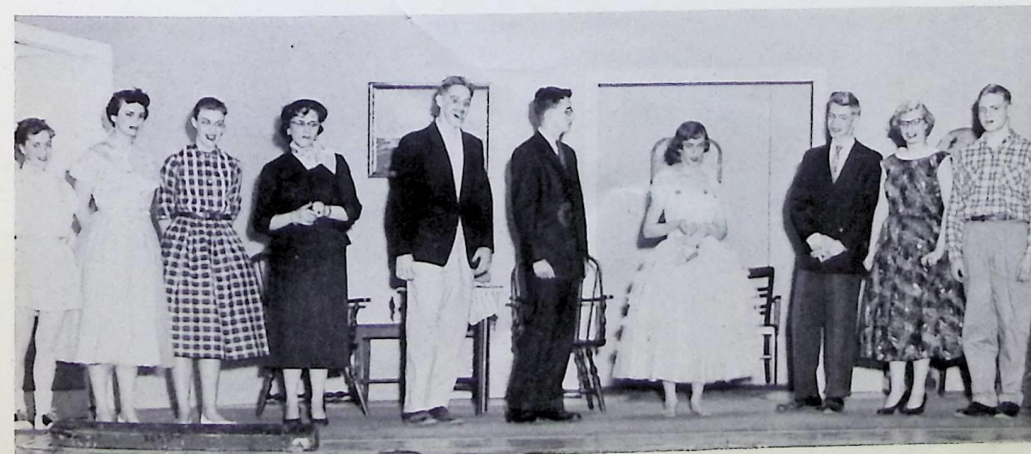

DIG THOSE CRAZY KNICKERS !

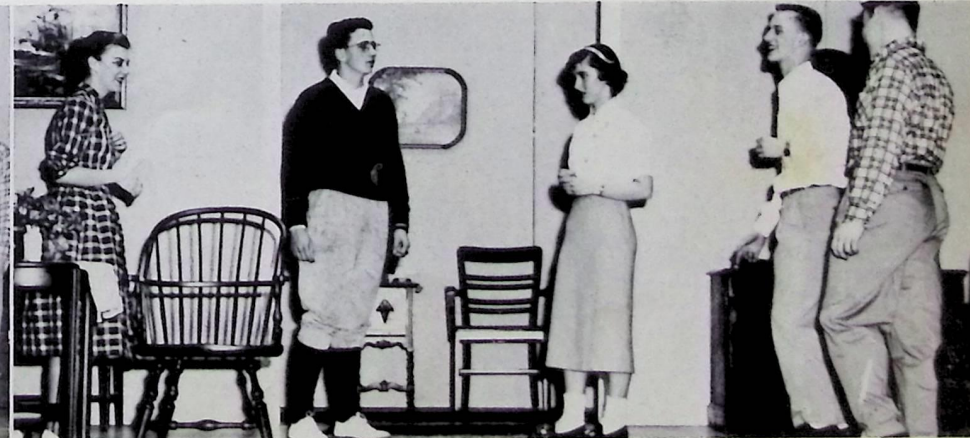



First Row: Donna Hogg, Judy Stendel, Sally Farran, Judy Rogers, Priscilla Ruddick, Gail York. Second Row: Cynthia Bouton, Carol Cox, Phyllis Patterson, Mona Weaver, June Ackroyd, Susan Parks. Third Row: Nancy Rosenberger, Roberta Widgren, Carolyn Blazy, Roberta Litwiler, Audrey Bailey. Fourth Row: Nancy Williams, Sue Hengst, Donna Waite, Vicky Tyler, Karen Wright, Jackie Stone.

# FRIENDSHIP CLUB

"Travel the U. S. with Us" was the theme of the Friendship Club this year. The girls started their tour of the U. S. with the Texas Roundup (Big Sister, Little Sister Party); the parties following were the Tennessee Jamboree (Informal Initiation), Pa. and Me. (Father-Daughter Picnic), Home for the Holidays (Christmas Party), Miss Debutante (Formal Initiation), Colonial Cotillion (Formal), Minnie and Paul (Hi-Y, F. C. Party), ALL US party, and ending with 5th Ave. Fashions (Mother-Daughter Tea).

A major change made in the club this year was the requirement that all new initiates complete an act of service before being allowed to join.

The tour was guided by Sally Farran, president; Judy Rogers, vice president; Judy Stendel, secretary; Priscilla Ruddick, treasurer; and co-advisors, Miss Adele Knight and Miss Marian Riemann.



MISS KNIGHT



MISS RIEMANN





# FRIENDSHIP CLUB

"Travel the U. S. with Us" was the theme of the Friendship Club this year. The girls started their tour of the U. S. with the Texas Roundup (Big Sister, Little Sister Party); the parties following were the Tennessee Jamboree (Informal Initiation), Pa. and Me. (Father-Daughter Picnic), Home for the Holidays (Christmas Party), Miss Debutante (Formal Initiation), Colonial Cotillion (Formal), Minnie and Paul (Hi-Y, F. C. Party), ALL US party, and ending with 5th Ave. Fashions (Mother-Daughter Tea).

A major change made in the club this year was the requirement that all new initiates complete an act of service before being allowed to join. The tour was guided by Sally Farran, president; Judy Rogers, vice president; Judy Stendel, secretary; Priscilla Ruddick, treasurer; and co-advisors, Miss Adele Knight and Miss Marian Riemann.

Priscilla  
yillis  
Nancy  
udrey  
Vicky



MISS RIEMANN



MISS KNIGHT



First Row: J. Dixon, J. Rauker, R. Needham, R. Wendell, R. Mullen. Second Row: R. Doyle, J. Gasier, J. Orick, B. Floyd, R. Parker, G. Bell. Third Row: D. Christian, M. LeRoy, B. Wotring, R. Mominey, C. Loach, J. Cullitan. Fourth Row: W. Fulton, D. Poole, A. Melton, E. Brott, T. Cassidy G. Williamson. Fifth Row: K. Lohmeyer, J. Matz, G. Jarmusch, D. Pelz, R. Miller, W. Schultz, H. Hender-shot.

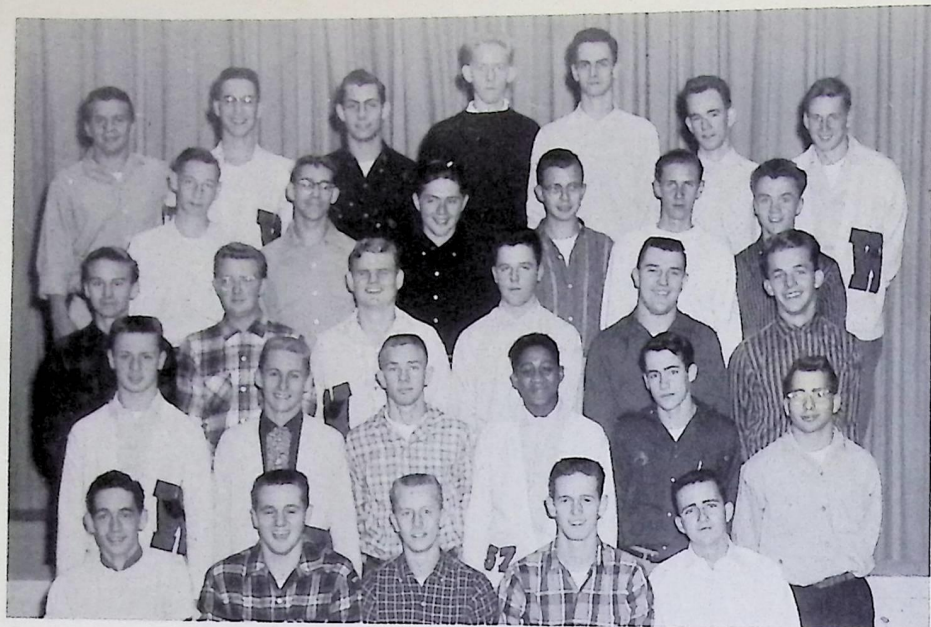

# 'HI-Y'

The Hi-Y is organized to maintain throughout the home, school, and community high standards of Christian character.

The officers are: Richard Needham, Pres., Bob Wendell, V.P., Dick Mullen, Sec., Jim Rauker, Treas., and Chaplain, Art Melton.

During the year the Hi-Y sponsored a Christmas Formal, at which Vicky Tyler was crowned sweetheart.

The activities of the Hi-Y this year included the operation of the concession stand at the Football games with the Friendship Club.

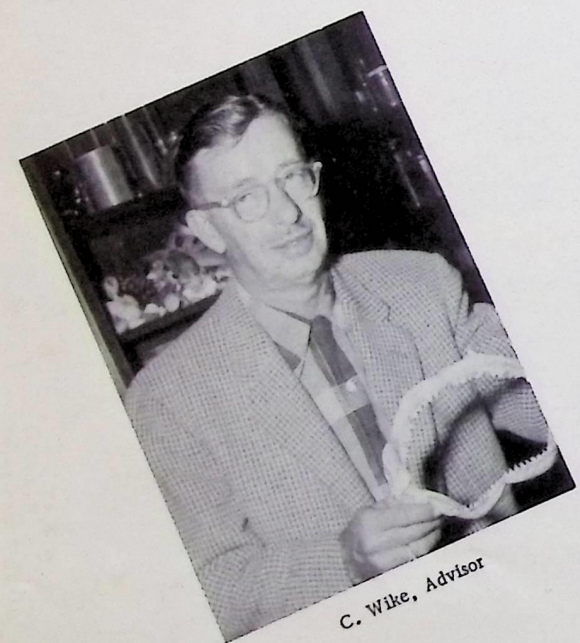

C. Wake, Advisor



Hi-Y Sweetheart Vicky Tyler



Christmas Formal

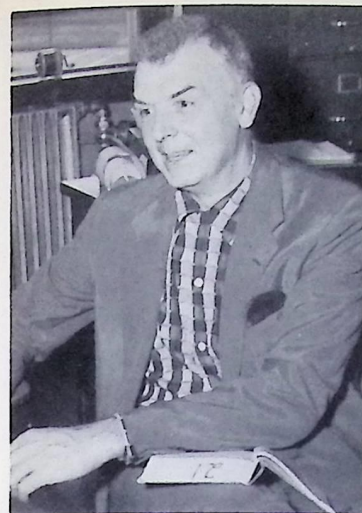

E. Edmunds, Advisor.

# JUNIOR COUNCIL ON WORLD AFFAIRS



First Row: B. Book, D. Hogg. Second Row: B. Halaburda, Foutz. Third Row: M. Gine, J. Ackroyd. Fourth Row: D. Butzer, J. Gasier, B. Smart.

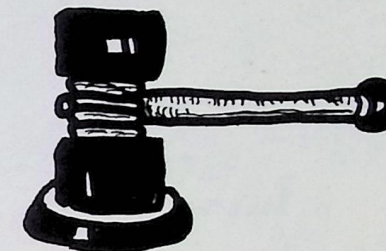

The Junior Council on World Affairs, meeting the second Wednesday of each month, is open to juniors and to seniors. This organization, sponsored by the Cleveland Council on World Affairs (all of whose meetings being open to the junior members) is affiliated through the Council with similar groups throughout the Greater Cleveland area. These groups meet together in an annual spring meeting which takes the form of a mock United Nations General Assembly where groups of students act as delegates from member states. The experience here gained in the exercise of the niceties of parliamentary law, the experience of debate during the sponsorship of resolutions, is interesting and valuable.

Monthly programs in the past have consisted of panel discussions, debates by outsiders, the interviewing of visitors to, or recent USA residents from, other countries, and of timely movies. These activities showed appeal to those students interested in widening or deepening their knowledge of world politics.

The officers of this group are: Donna Hogg, president; Laurine Purola, vice-president; Betty Book, secretary; Linda Thomas, social chairman and John Matz, program chairman.





# "HI-Y"

The Hi-Y is organized to maintain throughout the home, school, and community high standards of Christian character.

The officers are: Richard Needham, Pres., Bob Wendell, V.P., Dick Mullen, Sec., Jim Rauker, Treas., and Chaplain, Art Melton.

During the year the Hi-Y sponsored a Christmas Formal, at which Vicky Tyler was crowned sweetheart.

The activities of the Hi-Y this year included the operation of the concession stand at the Football games with the Friendship Club.



E. Edmunds, Advisor.

# JUNIOR COUNCIL ON WORLD AFFAIRS



First Row: B. Book, D. Hogg, L. Purola, A. Alpeter, E. Vura, L. Montanari. Second Row: B. Halaburda, L. Kennelly, S. Stahli, C. Cox, C. Shriner, A. Foutz. Third Row: M. Ginevra, J. Smith, L. Thomas, E. Rizer, C. Kramer, J. Ackroyd. Fourth Row: D. Frank, G. Perkins, W. Makowski, J. Matz, G. Butzer, J. Gasier, B. Smart.

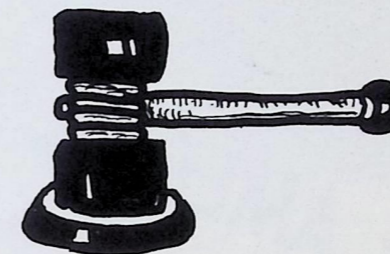

The Junior Council on World Affairs, meeting the second Wednesday of each month, is open to juniors and to seniors. This organization, sponsored by the Cleveland Council on World Affairs (all of whose meetings being open to the junior members) is affiliated through the Council with similar groups throughout the Greater Cleveland area. These groups meet together in an annual spring meeting which takes the form of a mock United Nations General Assembly where groups of students act as delegates from member states. The experience here gained in the exercise of the niceties of parliamentary law, the experience of debate during the sponsorship of resolutions, is interesting and valuable.

Monthly programs in the past have consisted of panel discussions, debates by outsiders, the interviewing of visitors to, or recent USA residents from, other countries, and of timely movies. These activities showed appeal to those students interested in widening or deepening their knowledge of world politics.

The officers of this group are: Donna Hogg, president; Laurine Purola, vice-president; Betty Book, secretary; Linda Thomas, social chairman and John Matz, program chairman.



Hi-Y Sweetheart Vicky Tyler



Christmas Formal



First Row:  
P. Riddle,  
C. Crawford,  
N. Williams,  
M. Ginevera,  
B. Book,  
Second Row:  
S. Furnas,  
L. Marhoefer,  
J. Mac,  
P. Cederval,  
M. Collins,  
Third Row:  
N. Mears,  
D. Frank,  
E. Rizer,  
M. Moody,  
J. Nelson,  
Fourth Row:  
V. Dodds,  
V. Dodds,  
D. Wade,  
B. Bullock,  
P. McLaughlen.

# FUTURE TEACHERS OF AMERICA

This year was a busy one for the F.T.A. Their many activities included ushering on N.E.O.T.A. Day, observing elementary school procedures, and holding a Valentine Party for retarded children. Many fine speakers were invited to their monthly meetings to discuss current problems in education.

Officers for the year are Pres., Nancy Williams; V.P., Mary Ginevera; Treas., Pat Riddle; and Sec., Carolyn Crawford.



A. Kassing, Advisor

# OFFICE STAFF



First Row: H. Presley, C. Cox, C. Snyder, K. Parnish, F. Chisholm, M.A. Kraker, A. Shaw, P. Mahoney. Second Row: C. Singer, M. Rice, P. Hogg, D. Whinnery, J. Perusek, M. Corlew, P. Frazier, G. Crocker.

Joy Cahill

Sylvia DeJoy

Wray Mills

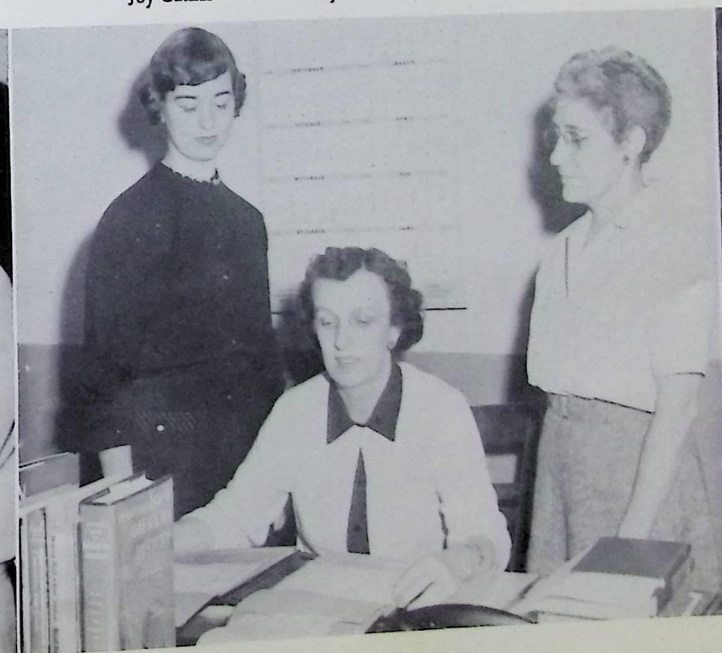



First Row:  
P. Riddle,  
C. Crawford,  
N. Williams,  
M. Ginevera,  
B. Book,  
Second Row:  
S. Furnas,  
L. Marhofer,  
J. Mac,  
P. Cederval,  
M. Collins,  
Third Row:  
N. Mears,  
D. Frank,  
E. Rizer,  
M. Moody,  
J. Nelson,  
Fourth Row:  
V. Dodds,  
V. Dodds,  
D. Wade,  
B. Bullock,  
P. McLaughlen.

# TEACHERS OF AMERICA

was a busy one for the F.T.A. activities included ushering on Day, observing elementary dures, and holding a Valentine d children. Many fine invited to their monthly discuss current problems in for the year are Pres., Nancy P., Mary Ginevera; Treas., and Sec., Carolyn Crawford.



A. Kassing, Advisor

# OFFICE STAFF



First Row: H. Presley, C. Cox, C. Snyder, K. Parnish, F. Chisholm, M.A. Kraker, A. Shaw, P. Mahoney. Second Row: C. Singer, M. Rice, P. Hogg, D. Whinnery, J. Perusek, M. Corlew, P. Frazier, G. Crocker.

Without the assistance of the Office Staff, the many routine problems of the average school day would be more complex. The pages who assist the secretaries competently handle many jobs which include; running the errands, collecting absence slips, delivering messages from office, and operating the switch board.

Joy Cahill      Sylvia DeJoy      Wray Mills





Seated: W. Rice, P. Zemple, P. Russo, W. Orloff, I. Kenyon, J. Wallace, T. Prindle, D. Megginson.

# MATH CLUB

President, Phil Russo, Vice President, Jim Heltman, and Reporter, Ann Allen, preside over the monthly meetings of the Math Club. These meetings give the students interested in math an opportunity to learn more about the various fields of mathematics.

Mrs. Alice Randles in the Club's advisor.

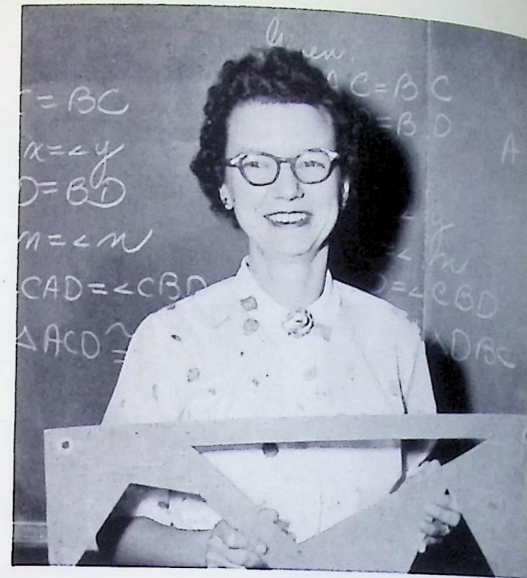

A. Randles, Advisor

First Row: A. Angus, A. Allen, P. Russo, D. Radebaugh. Second Row: K. Hoffman, B. Bilton, L. Goldrick, J. Landman, A. Heltman, W. Schultz, J. Lattimore.



# SCIENCE CLUB

Each member of the Science Club was required to complete a workable scientific project by the end of the first semester. These projects were then entered in the N.E. Ohio Science Fair in the Spring.

Officers are: Phil Russo, President; Wes Orloff, Vice President; Jim Wallace Treasurer; Pauline Zempel, Secretary; and advisor; Chris Artale.

The officers and members try to increase the student knowledge of science.

C. Artale, Advisor



# LATIN CLUB



First Row: C. Kaluga, B. Webber, P. Cedervall, J. Bejgar, H. Lohmeyer, P. Koster, S. Hobbs, B. Rotman, D. We J. Colle, J. Hoge. Second Row: M. Harbath, G. Evans, D. Hartman, C. Taylor, B. Smart, S. Siddons, M. Disbr hoefer, J. Mack, A. Henderson, E. Sears, D. Dewald, F. Martich. Third Row: T. Beal, J. Bukovec, S. Rose, S. Bouton, J. Stone, J. Dickson, J. Nash, P. Riddle, C. Coward, J. McNea, W. Makowski. Fourth Row: D. Schultz, J. Peters, E. Richter, M. Gubanc, C. Crawford, D. Wade, C. Bishop, G. Beck, B. Weiss, V. Baker, J. Cook, B. Fifth Row: B. Wendell, T. Burgess, W. Rice, D. Bousquet, J. Soul, D. Skinner, B. Miner, T. Maston, B. Phifer, D. Keyerleber, B. Hamilton, G. Butzer.

Miss Knight



The Latin Club is now affiliated with the American Jr. Classical League, a national organization.

The local activities include a signs of the zodiac party, a mythological story party, a Roman banquet, an astronomy meeting and a picnic.

The officers are: Consul, Bill Wendell; Pro-Consul, Tom Mastin; Scriba, Carolyn Crawford; and Juæstor, Jane Colle. Miss Adele Knight is the club advisor.



# MATH CLUB



Kenyon, J. Wallace, T. Prindle,

President, Phil Russo, Vice President, Jim Heltman, and Reporter, Ann Allen, preside over the monthly meetings of the Math Club. These meetings give the students interested in math an opportunity to learn more about the various fields of mathematics.

Mrs. Alice Randles in the Club's advisor.

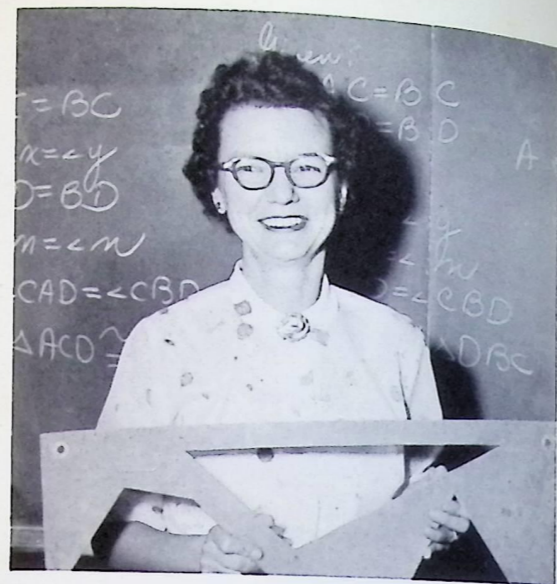

A. Randles, Advisor

First Row: A. Angus, A. Allen, P. Russo, D. Radebaugh. Second Row: K. Hoffman, B. Bilton, L. Goldrick, J. Landman, A. Heltman, W. Schultz, J. Lattimore.



# SCIENCE CLUB

Each member of the Science Club was required to complete a workable scientific project by the end of the first semester. These projects were then entered in the N.E. Ohio Science Fair in the Spring.

Officers are: Phil Russo, President; Wes Orloff, Vice President; Jim Wallace Treasurer; Pauline Zempel, Secretary; and advisor; Chris Artale.

The officers and members try to increase the student knowledge of science.

# LATIN CLUB



First Row: C. Kaluga, B. Webber, P. Cedervall, J. Bejgar, H. Lohmeyer, P. Koster, S. Hobbs, B. Rotman, D. Wollschleger, J. Colle, J. Hoge. Second Row: M. Harbath, G. Evans, D. Hartman, C. Taylor, B. Smart, S. Siddons, M. Disbro, L. Marhoefer, J. Mack, A. Henderson, E. Sears, D. Dewald, F. Martich. Third Row: T. Beal, J. Bukovec, S. Rose, S. Gidley, C. Bouton, J. Stone, J. Dickson, J. Nash, P. Riddle, C. Coward, J. McNea, W. Makowski. Fourth Row: D. Schultz, J. Burch, J. Peters, E. Richter, M. Gubanc, C. Crawford, D. Wade, C. Bishop, G. Beck, B. Weiss, V. Baker, J. Cook, B. Jonke. Fifth Row: B. Wendell, T. Burgess, W. Rice, D. Bousquet, J. Soul, D. Skinner, B. Miner, T. Maston, B. Phifer, B. Vesí, D. Keyerleber, B. Hamilton, G. Butzer.

Miss Knight



The Latin Club is now affiliated with the American Jr. Classical League, a national organization.

The local activities include a signs of the zodiac party, a mythological story party, a Roman banquet, an astronomy meeting and a picnic.

The officers are: Consul, Bill Wendell; Pro-Consul, Tom Mastin; Scriba, Carolyn Crawford; and Juaestor, Jane Colle. Miss Adele Knight is the club advisor.

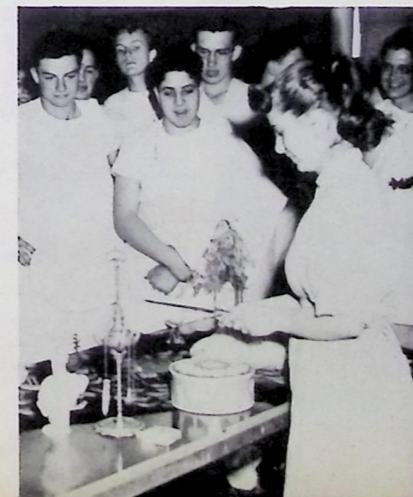



Breaking the pinata

# SPANISH CLUB

Buenos días. Que tal? was the official greeting of the monthly meetings of the Spanish Club. This organization, sponsored by Senora Puyau, gives the students studying Spanish, a chance to enjoy their knowledge by participating in Spanish games, songs, and conversations.

The officers of the club were: Pres., Barb Meyers; V.P., Dan Kennedy; Sec., Toni Gubanc; and Treas., Bill Wargo.



First Row: D. Kennedy, B. Wargo, B. Meyers, T. Gubanc, D. Brezic. Second Row: J. Petrusis, B. Rotman, V. Dunlap, M. Spence, L. Montanari. Third Row: M. Maudy, C. LaVerne, J. Gerbec, P. Brent, S. Kushlan. Fourth Row: D. Probst, J. Hardgrove, C. Boulton, L. Donovan, L. Jarmusch, D. Fevold.



Mrs. Puyau, Advisor

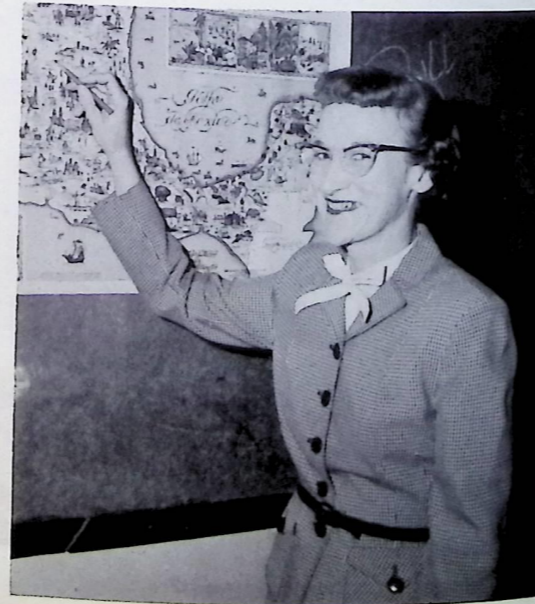

# RIFLE CLUB

The Rifle Club provided its members with an opportunity to learn the proper use of firearms and the chance to become skilled in the use of a rifle. The club meets weekly at the Ohio Rubber Company Rifle Range. The climax of the season is the N.R.A. Regional Championships in which the club's five best shooters participate.

The officers are: Bob Mellen, president; Art Melton, vice president; John Stange, secretary-treasurer; Burt Schwartz, Range officer; Bill Miller, statician.

Members of the club are: First Row: S. O'Donnell, B. Schultz, B. Miller, B. Mellen, A. Melton, S. Noss. Second Row: G. Butzer, D. Christian, B. Spate, F. Kidner, R. Milner, H. Hayford, G. Harwood. Third Row: D. Hamner, R. Tittle, T. Gruelle, R. Cox, T. Beal, B. Blake, A. Edgell. Fourth Row: T. Loar, D. Pepin, D. Gogard, F. Little, B. Anderson, L. Whitmer, B. Schwartz.



# FRENCH CLUB

Mr. Lake, Advisor



The members of the French Club, with Mr. Lake as their advisor, hold meetings monthly in the homes of its various members.

The objective of the club is to create a greater interest in French language, customs, and culture.

This year the group was headed by Phyllis Patterson, Pres., Carol Schriener, V.P., and Rochelle Roberts, Treas.



First Row: R. M. Roberts, C. Shriener



# SPANISH CLUB

Buenos dias. Que tal? was the official greeting of the monthly meetings of the Spanish Club. This organization, sponsored by Senora Puyau, gives the students studying Spanish, a chance to enjoy their knowledge by participating in Spanish games, songs, and conversations.

The officers of the club were: Pres., Barb Meyers; V.P., Dan Kennedy; Sec., Toni Gubanc; and Treas., Bill Wargo.



winata



First Row: D. Kennedy, B. Wargo, B. Meyers, T. Gubanc, D. Brezic. Second Row: J. Petruis, B. Rotman, V. Dunlap, M. Spence, L. Montanari. Third Row: M. Maudy, C. LaVerne, J. Gerbec, P. Brent, S. Kushlan. Fourth Row: D. Probst, J. Hardgrove, C. Bouton, L. Donovan, L. Jarmusch, D. Fevold.



Mrs. Puyau, Advisor

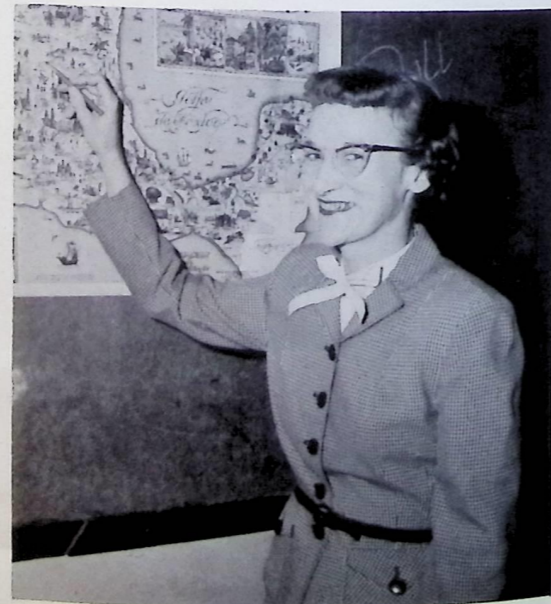

# RIFLE CLUB

The Rifle Club provided its members with an opportunity to learn the proper use of firearms and the chance to become skilled in the use of a rifle. The club meets weekly at the Ohio Rubber Company Rifle Range. The climax of the season is the N.R.A. Regional Championships in which the club's five best shooters participate.

The officers are: Bob Mellen, president; Art Melton, vice president; John Stange, secretary-treasurer; Burt Schwartz, Range officer; Bill Miller, statician.

Members of the club are: First Row: S. O'Donnell, B. Schultz, B. Miller, B. Mellen, A. Melton, S. Noss. Second Row: G. Butzer, D. Christian, B. Spate, F. Kidner, R. Milner, H. Hayford, G. Harwood. Third Row: D. Hamner, R. Tittle, T. Gruelle, R. Cox, T. Beal, B. Blake, A. Edgell. Fourth Row: T. Loar, D. Pepin, D. Gogard, F. Little, B. Anderson, L. Whitmer, B. Schwartz.

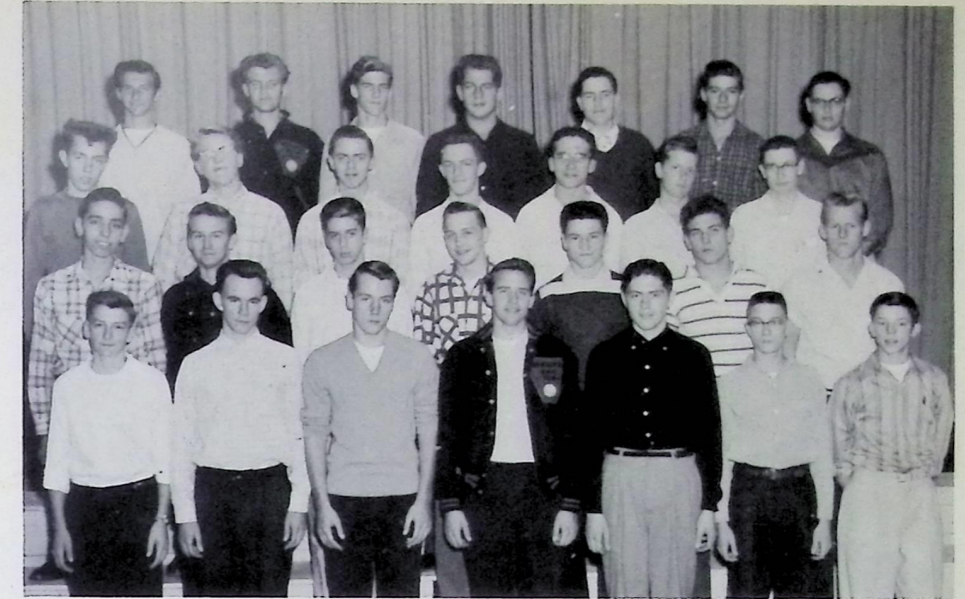

# FRENCH CLUB

Mr. Lake, Advisor



The members of the French Club, with Mr. Lake as their advisor, hold meetings monthly in the homes of its various members.

The objective of the club is to create a greater interest in French language, customs, and culture.

This year the group was headed by Phyllis Patterson, Pres., Carol Schriener, V.P., and Rochelle Roberts, Treas.



First Row: R. Morgan, K. Hoffman, R. Cox. Second Row: S. Parks, R. Roberts, C. Shriener, S. Hengst, P. Patterson.



Ready! Set . . . !



Slugger!

## "W" CLUB

Left to Right: A. Cooke, S. Gill, C. Crawford, G. Crocker, P. Ruddick, L. Montonari, K. Wright, M. Mestrovich, B. Murray, V. Tyler, D. Frank, D. Waite, B. Book, J. Schaer, A. Shaw, D. Hogg, N. Leonello, G. Doskocil, J. Dickson, A. Alpeter, J. Cooke, C. Schriener, A. Mancini.



M. Dansforth, Advisor.

The aim of the "W" Club is to promote interest in athletics and to develop a sense of good sportsmanship among the members. The girls are chosen for membership on the basis of initiative, scholarship, and interest in school activities.

Club functions for the year included: Dad's Night Program, the "Highland Fling" Dance, group attendance at the Ice Capades and a Spring Banquet.

Officers: Karen Wright, President; Nancy Leonello, Vice President; Donna Hogg, Secretary and Treasurer, Arlene Mancini.

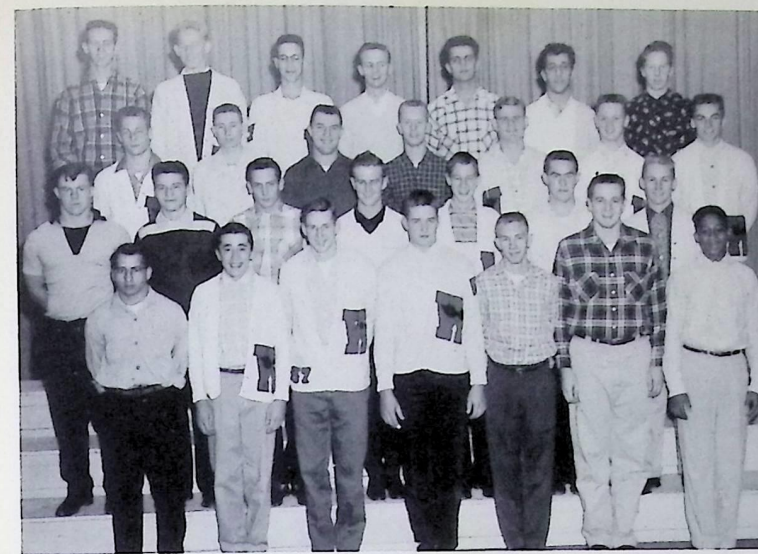

First Row: G. Bell, E. Richards, H. Hendershot, J. Thompson, J. Orick, J. Rauker, B. Floyd. Second Row: R. Lang, R. Milner, G. Harris, R. Sweeney, B. Bourguard, D. Porter, J. Gasier. Third Row: J. Fickes, A. Edgell, C. Loach, D. Needham, B. Wotring, B. Doyle, T. Geiling. Fourth Row: B. Wendell, D. Pelz, J. Matz, B. Gongas, W. Tring, F. Vitale, D. Lino.

J. Bryan, J. Littleton, G. Dawson

## VARSITY CLUB

The Varsity Club, whose membership consists of Varsity letter winners, contributed much atmosphere to the W.H.S. scene this year by selling colorful book bags, sweatshirts and caps.

Other activities included attending a Brown's football game, preparing a Christmas basket and holding an initiation.

This year's officers are: Pres., Jim Rauker; V.P., Junior Orick; Sec., Harold Hendershot; and Treas., Joe Thompson.

## MAINTENANCE

With the half day sessions in progress these people had an exceptionally busy year. In spite of the added difficulties everything ran as smoothly as before.

If early risers complained, they should have thought of their faithful bus drivers who had to rise at least a half hour before them.

Our clean sidewalks and our fresh green lawns will always stand tribute to our maintenance staff.





Slugger!

## "W" CLUB

Left to Right: A. Cooke, S. Gill, C. Crawford, G. Crocker, P. Ruddick, L. Montonari, K. Wright, M. Mestrovich, B. Murray, V. Tyler, D. Frank, D. Waite, B. Book, J. Schaer, A. Shaw, D. Hogg, N. Leonello, G. Doskocil, J. Dickson, A. Alpeter, J. Cooke, C. Schriener, A. Mancini.

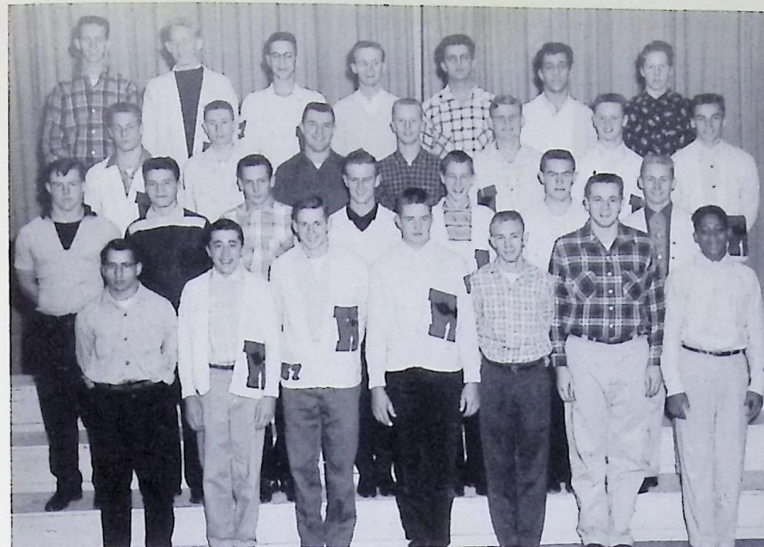

First Row: G. Bell, E. Richards, H. Hendershot, J. Thompson, J. Orick, J. Rauker, B. Floyd. Second Row: R. Lang, R. Milner, G. Harris, R. Sweeney, B. Bourguard, D. Porter, J. Gasier. Third Row: J. Fickes, A. Edgell, C. Loach, D. Needham, B. Wotring, B. Doyle, T. Geiling. Fourth Row: B. Wendell, D. Pelz, J. Matz, B. Gongas, W. Tring, F. Vitale, D. Lino.

J. Bryan, J. Littleton, G. Dawson



## MAINTENANCE

With the half day sessions in progress these people had an exceptionally busy year. In spite of the added difficulties everything ran as smoothly as before.

If early risers complained, they should have thought of their faithful bus drivers who had to rise at least a half hour before them.

Our clean sidewalks and our fresh green lawns will always stand tribute to our maintenance staff.

## VARSITY CLUB

The Varsity Club, whose membership consists of Varsity letter winners, contributed much atmosphere to the W.H.S. scene this year by selling colorful book bags, sweatshirts and caps.

Other activities included attending a Brown's football game, preparing a Christmas basket and holding an initiation.

This year's officers are: Pres., Jim Rauker; V.P., Junior Orick; Sec., Harold Hendershot; and Treas., Joe Thompson.



Harry Winters





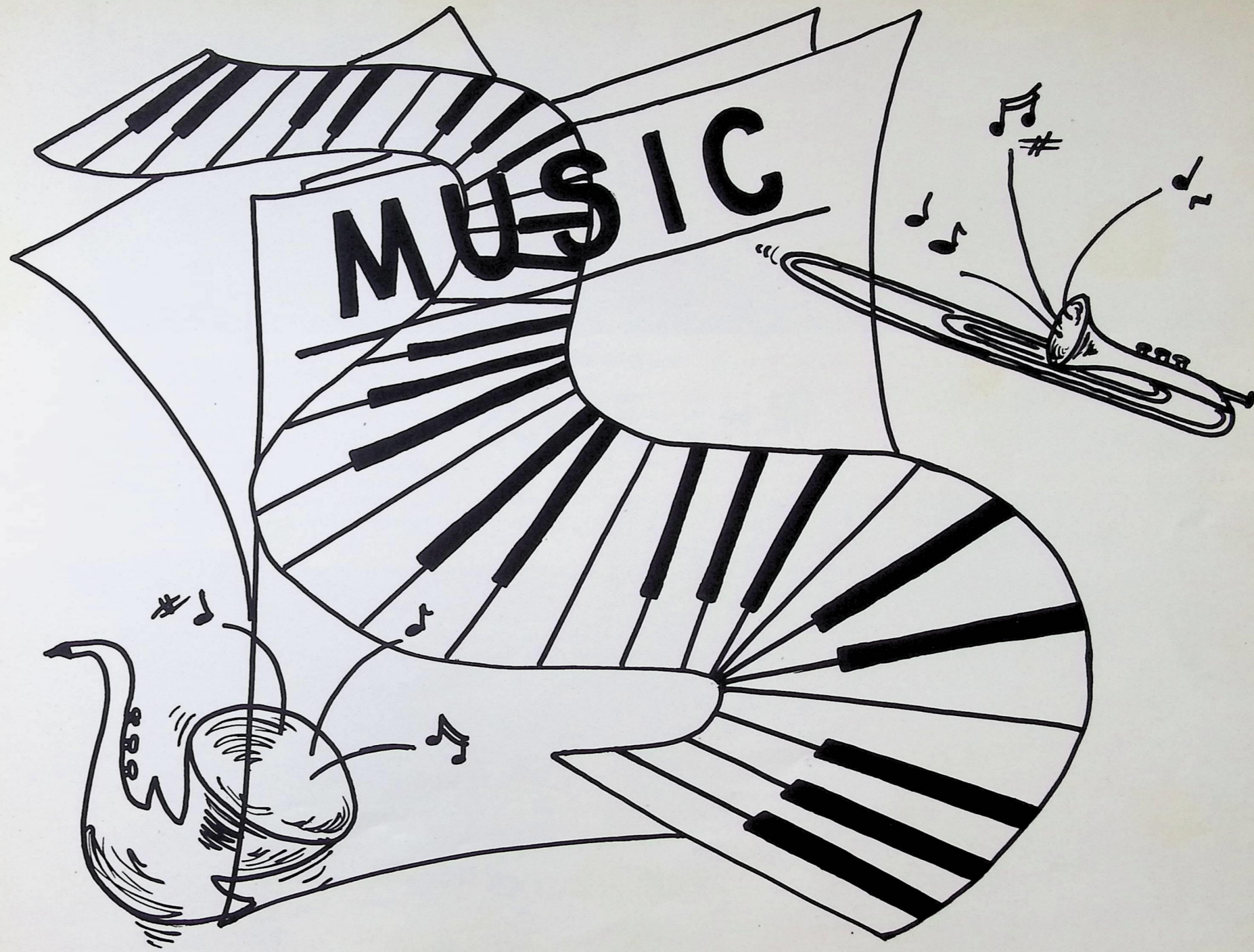



W. H. S. CONCERT BAND

# W.H.S. BANDS

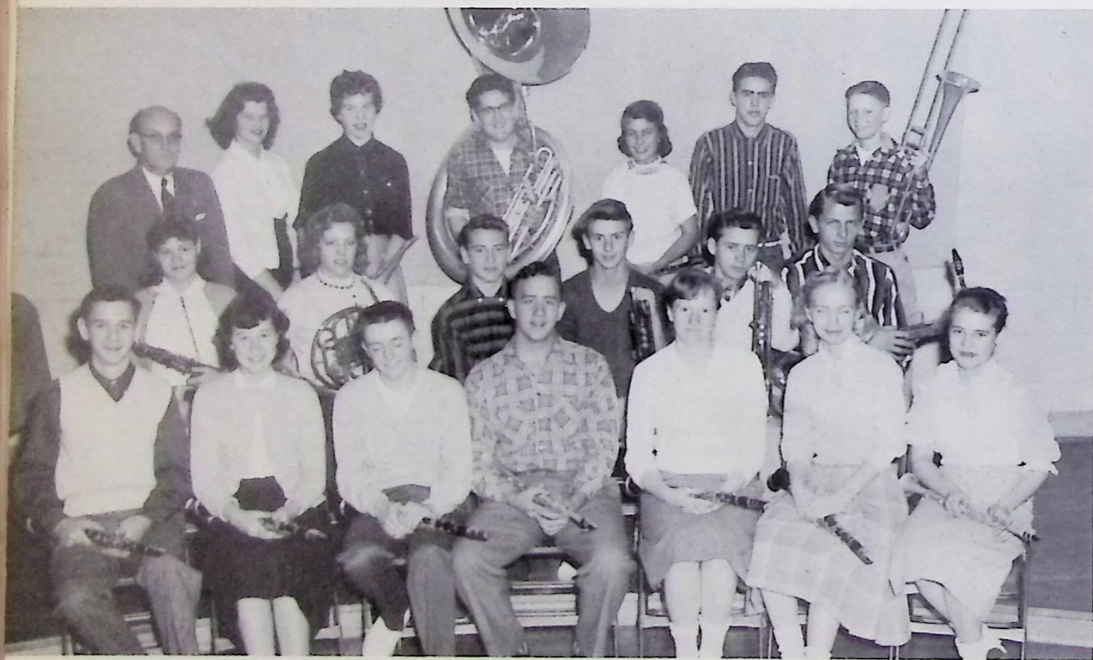

First Row: B. Jonke, V. Baker, B. Cox, F. Orloff, P. Riddle, S. Hobbs, M. Morris. Second Row: G. Evans, S. Forrester, J. Soul, T. Collins, T. Lewis, L. Cicek. Third Row: Mr. Ruddick, L. Saxe, P. McGloughlin, J. Burke, L. Saler, P. Beckberger, T. Morgan.

Willoughby High School's Concert Band, one of the finest in Ohio, gives a Spring Concert and appears in the Christmas program with the choral groups each year.

The Concert Band also plays for many other events, including a combined concert at Bay Village High School.

The band competes each year in the district contest and always does extremely well.

Candy sales, endless practicing, and lots of fun were the keynotes and highlights of the 1957 Concert Band's year.

Officers of the Concert Band are: Linda Donovan, president; Bob Mellen, vice-president; Gail Daskocil, secretary; Dennis Atkins, treasurer.



MR. RUDDICK, DIRECTOR



OUR NATIONAL ANTHEM

Flashing orange and black uniforms, high stepping white bucks, and sparkling instruments denote the Willoughby High School Marching Band.

The band's sixty members, directed by Charles D. Ruddick, assisted by Raymond Rinaldi and Miss Jean Kelly, were led in each of their performances by four peppy majorettes: Priscilla Ruddick, Linda Saler, Diane Radebaugh, and Pat McLaughlin, and drum major, Wayne Makowski.

The band started the season with a memorable

trip to Florida to compete in the Lion's Club Convention Parade.

The band members and directors also attended Camp Chibiabos at Doylestown, Ohio. Here they learned and practiced the steps essential to the clever formations put on at each football game.

The officers for the Marching Band are President, Linda Donovan; Vice-president, Bob Mellen; Secretary, Gail Daskocil; and Treasurer, Dennis Atkins.



W. H. S. MARCHING BAND



RANGERETTE



W. H. S. CONCERT BAND

# W.H.S. BANDS



First Row: S. Hobbs, M. Morris. Second Row: G. Evans, L. Saxe, P. McLaughlin. Third Row: Mr. Ruddick.

Willoughby High School's Concert Band, one of the finest in Ohio, gives a Spring Concert and appears in the Christmas program with the choral groups each year.

The Concert Band also plays for many other events, including a combined concert at Bay Village High School.

The band competes each year in the district contest and always does extremely well.

Candy sales, endless practicing, and lots of fun were the keynotes and highlights of the 1957 Concert Band's year.

Officers of the Concert Band are: Linda Donovan, president; Bob Mellen, vice-president; Gail Duskocil, secretary; Dennis Atkins, treasurer.



MR. RUDDICK, DIRECTOR



OUR NATIONAL ANTHEM

Flashing orange and black uniforms, high stepping white bucks, and sparkling instruments denote the Willoughby High School Marching Band.

The band's sixty members, directed by Charles D. Ruddick, assisted by Raymond Rinaldi and Miss Jean Kelly, were led in each of their performances by four peppy majorettes: Priscilla Ruddick, Linda Saler, Diane Radebaugh, and Pat McLaughlin, and drum major, Wayne Makowski.

The band started the season with a memorable

trip to Florida to compete in the Lion's Club Convention Parade.

The band members and directors also attended Camp Chibiabos at Doylestown, Ohio. Here they learned and practiced the steps essential to the clever formations put on at each football game.

The officers for the Marching Band are President, Linda Donovan; Vice-president, Bob Mellen; Secretary, Gail Duskocil; and Treasurer, Dennis Atkins.



DRUM MAJOR, Wayne Makowski



W. H. S. MARCHING BAND



RANGERETTES: L. Saler, P. McLaughlin, D. Radebaugh, P. Ruddick.



Our holiday assemblies this year were highlighted by the singing of the Choir.

This fine choral group sang often during the year for the

students of Willoughby High School. The choir also

distinguished themselves at many of the various

music festivals throughout the county and climaxed their successful

season by receiving a superior rating in the State Contest.

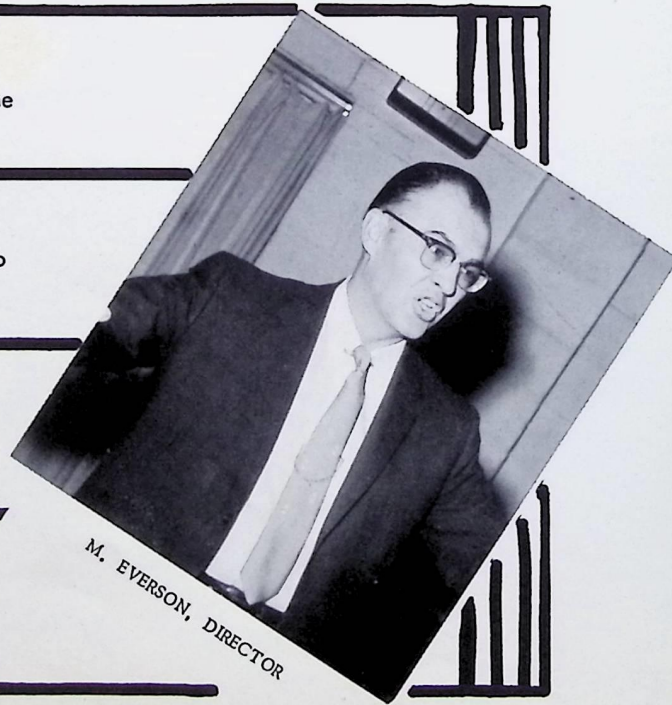

M. EVERSON, DIRECTOR



P. Ruddick, M. Crookham, J. Campbell, C. Cox.

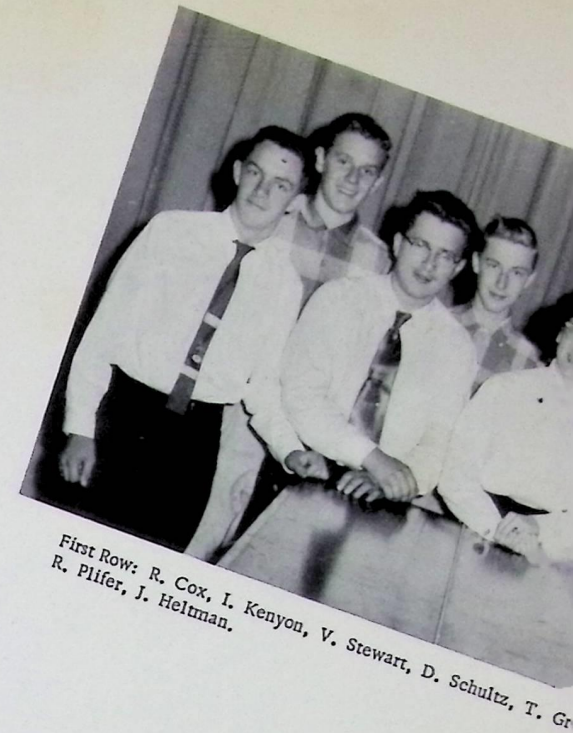

First Row: R. Cox, I. Kenyon, V. Stewart, D. Schultz, T. Gr  
R. Plifer, J. Heltman.

## ENSEMBLES



J. Stendel, G. York, M. Weaver, R. Widgren, P. Ruddick, M. Crookham, T. Gubanc, M. Miller, J. Campbell, C. Cox.





ur holiday assemblies this year were highlighted by the singing of the Choir.

This fine choral group sang often during the year for the

students of Willoughby High School. The choir also

distinguished themselves at many of the various

ivals throughout the county and climaxed their successful

on by receiving a superior rating in the State Contest.

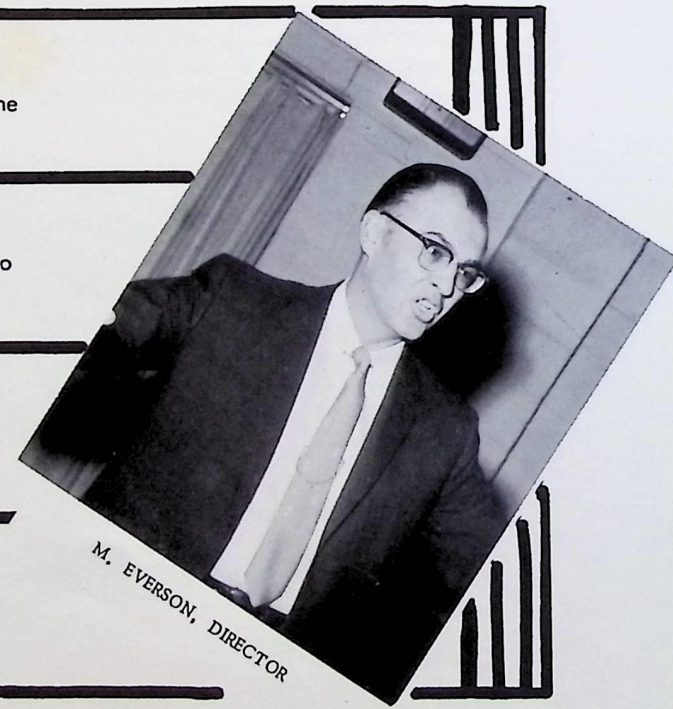

M. EVERSON, DIRECTOR



P. Ruddick, M. Crookham, J. Campbell, C. Cox.



First Row: R. Cox, I. Kenyon, V. Stewart, D. Schultz, T. Gruelle. Second Row: L. Buhl, R. Plifer, J. Heltman.

## ENSEMBLES



J. Stendel, G. York, M. Weaver, R. Widgren, P. Ruddick, M. Crookham, T. Gubanc, M. Miller, J. Campbell, C. Cox.



# GIRLS' GLEE CLUB

This year the Girls' Glee Club, directed by Mr. Maynard Everson, provided many enjoyable musical moments for W. H. S. They participated in the Christmas Concert, singing "Oh Sacred Heart." At the District Contest they sang "Take Joy Home" and "To You."

This year the officers of the Glee Club are: Pres., Ginnie Stewart; V.P., Sally Fedor; and Sec., Kay Jackson.

First Row: P. Miller, S. Flack, A. Henderson, N. Neubacher, D. Haagen, B. Dickson, G. Stewart, N. Adams, S. Gidley, C. Brettrager. Second Row: P. Krinsky, S. Lamos, C. Veit, D. Case, I. Sluga, M. Disbro, S. Boyle, S. Fedor, C. Bradley, P. Moon. Third Row: M. Rice, B. Edwards, J. Simoncic, A. Hahn, D. Miller, B. Smart, J. Scharr, G. Hambrect, P. Ruddick, C. Crawford, J. Stendel. Fourth Row: D. Evans, C. Faflik, B. Mihalik, M. Harris, E. Schmidt, E. Sears, K. Pearson, M. O'Donnell, M. Kuhn, E. Coughlin.

# BOYS' GLEE CLUB

The Boys' Glee Club, which is composed of those boys taking the course and those in the Choir who are interested in going to District Contest with the group, is under the direction of Mr. Maynard Everson.

The pieces they selected for contest are: "Praise Ye the Lord," and "High Barbaree."

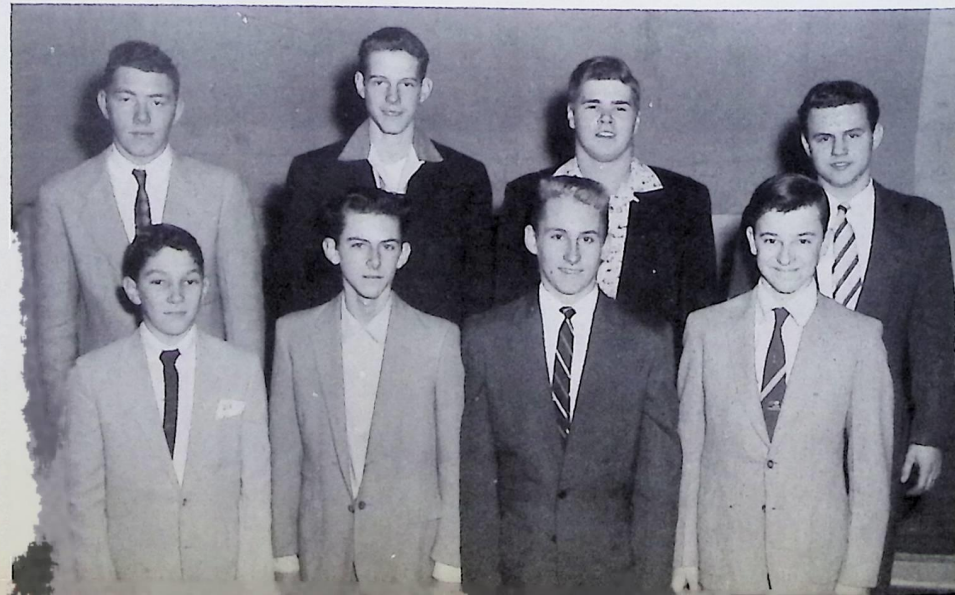

First Row: A. Costello, Hickman, J. Gasier, B. Foster. Second Row: R. McCauley, G. Counts, C. Price, R. Hartman.

# SPORTS

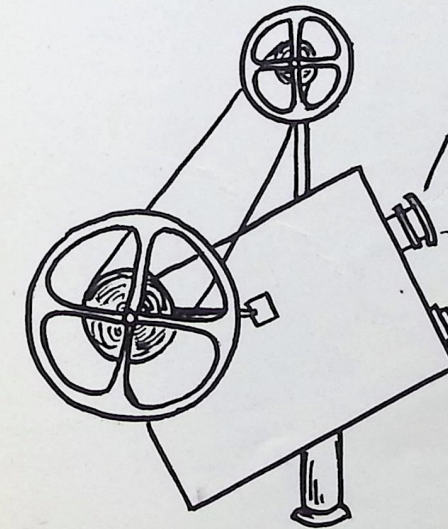
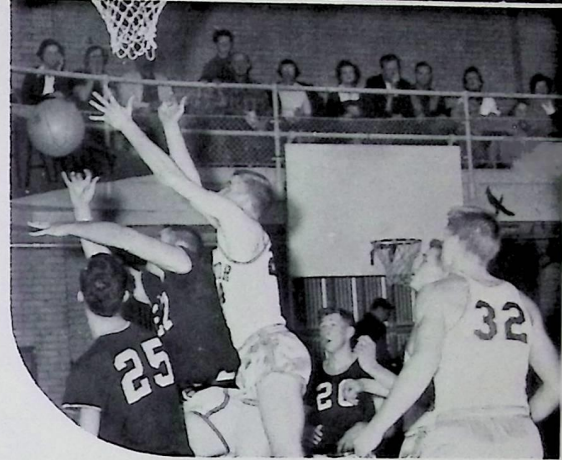

# NEWS



# GIRLS' GLEE CLUB

This year the Girls' Glee Club, directed by Mr. Maynard Everson, provided many enjoyable musical moments for W. H. S. They participated in the Christmas Concert, singing "Oh Sacred Heart." At the District Contest they sang "Take Joy Home" and "To You."

This year the officers of the Glee Club are: Pres., Ginnie Stewart; V.P., Sally Fedor; and Sec., Kay Jackson.

cher, D. Haagen, B. Dickson, G. Stewart, N. Adams, S. Gidley, C. Brettrager. Second  
a, M. Disbro, S. Boyle, S. Fedor, C. Bradley, P. Moon. Third Row: M. Rice, B. Ed-  
charr, G. Hambrect, P. Ruddick, C. Crawford, J. Stendel. Fourth Row: D. Evans, C.  
Pearson, M. O'Donnell, M. Kuhn, E. Coughlin.

First Row: A. Costello, Hickman, J. Gasier,  
B. Foster. Second Row: R. McCauley, G.  
Counts, C. Price, R. Hartman.

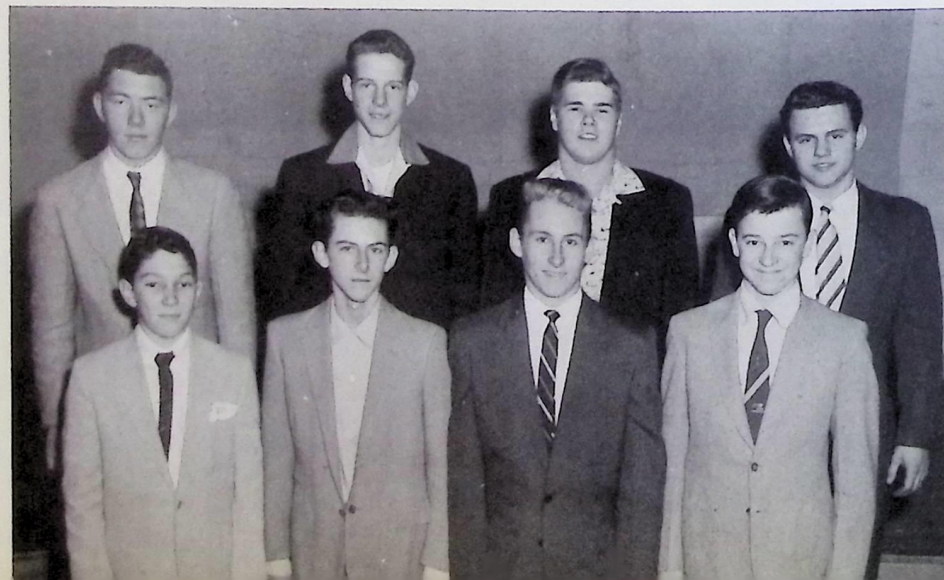

Boys' Glee Club, which is composed of boys taking the course and those in their who are interested in going to Contest with the group, is under the direction of Mr. Maynard Everson. The pieces they selected for contest are: "Ye the Lord," and "High Barbaree."

# SPORTS

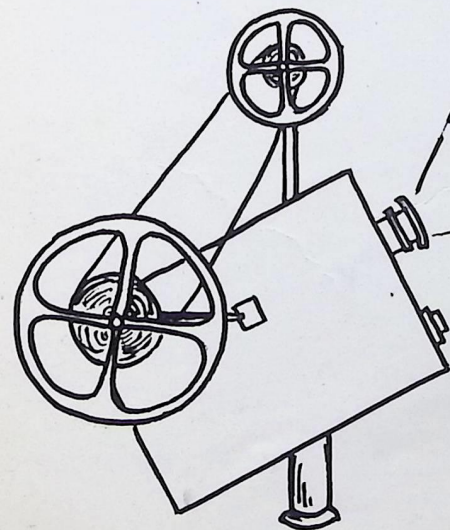
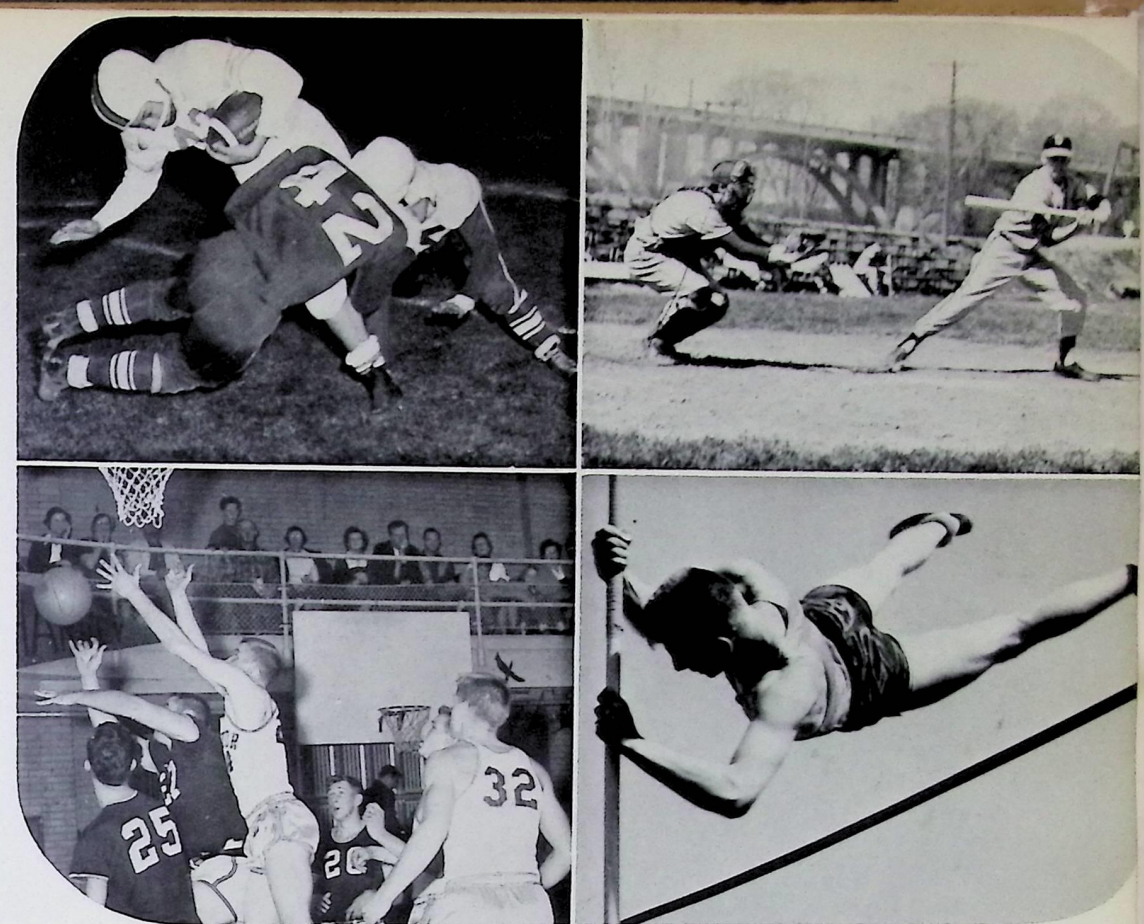

# NEWSREEL



Tom Geiling



John Matz



Jim Rauker

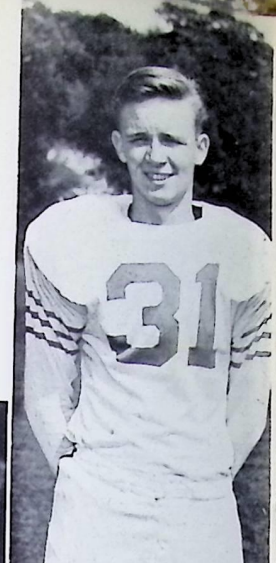

Bob Gongas



Chuck Loach

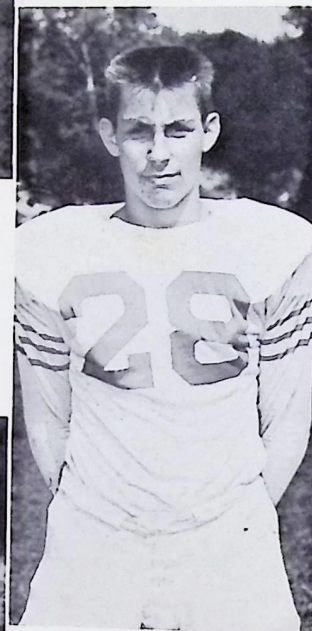

Gary Jarmusch



Billy Floyd

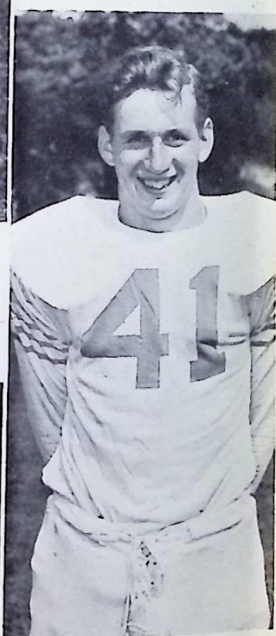

Hal Hendershot

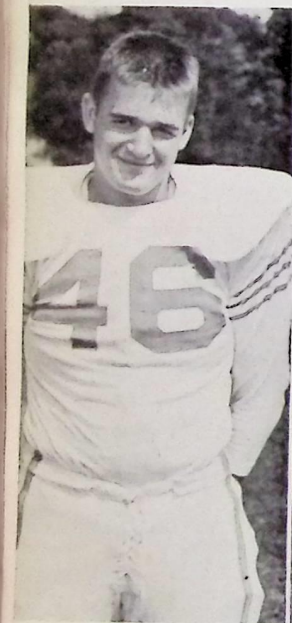

Joe Thompson

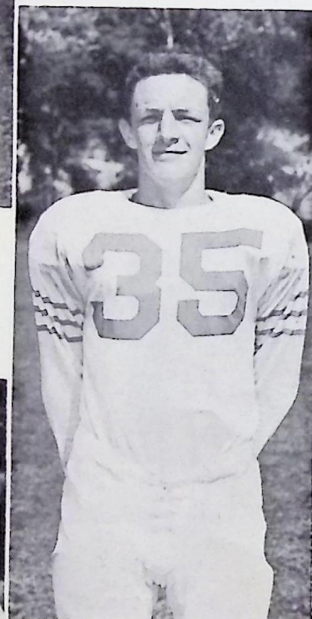

Dick Cox

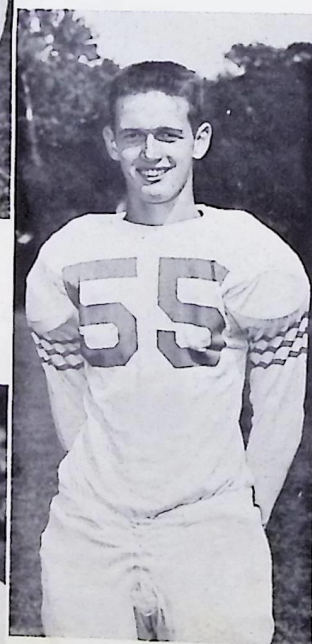

Bob Wendell



Bruce Worring



Ronnie Lang



Glen Bell

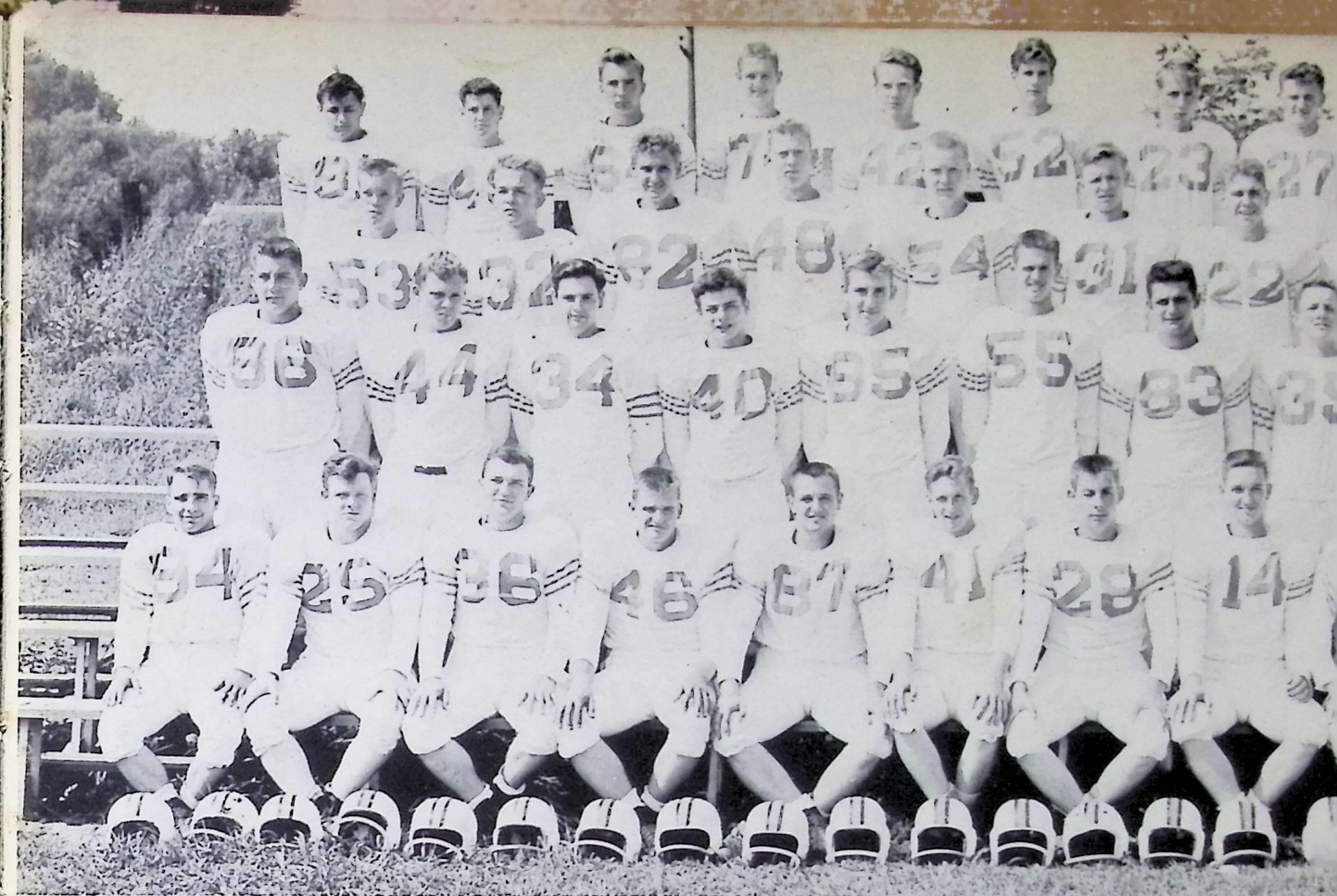

COACHES: J. Kost, H. Winters, S. Foster, K. Potter.

# FOOTBALL

Although the Ranger Gridders sharing the GCC cellar with Bed without its share of thrills and br Harry Winters' stalwarts.

Among the latter was the sele eran Jim Rauker as All-Conferen Hendershot and Ronnie Lang to th and tackle slots.

WHS	20	Post Me
	32	Riverside
	12	Lutheran
	6	Garfield
	7	Maple Hts
	13	Brush
	0	Bedford
	2	Berea
		Mentor



John Matz



Jim Rauker



Bob Gongas

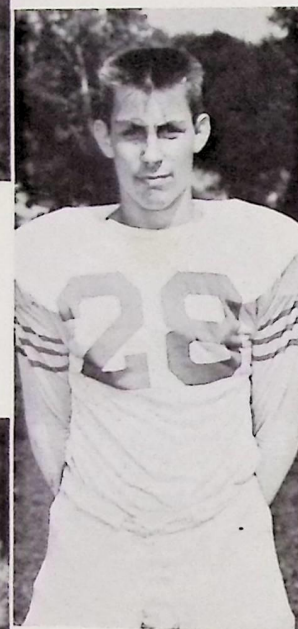

Gary Jarmusch



Billy Floyd



Dick Cox

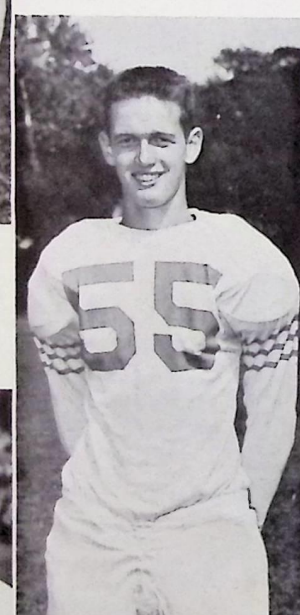

Bob Wendell



Hal Hendershot

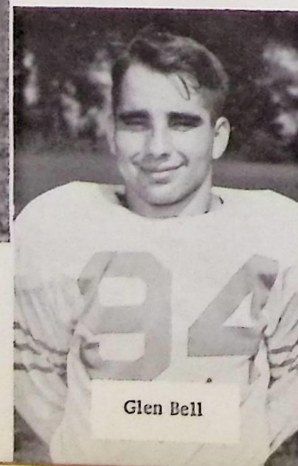

Glen Bell



Bruce Wotring

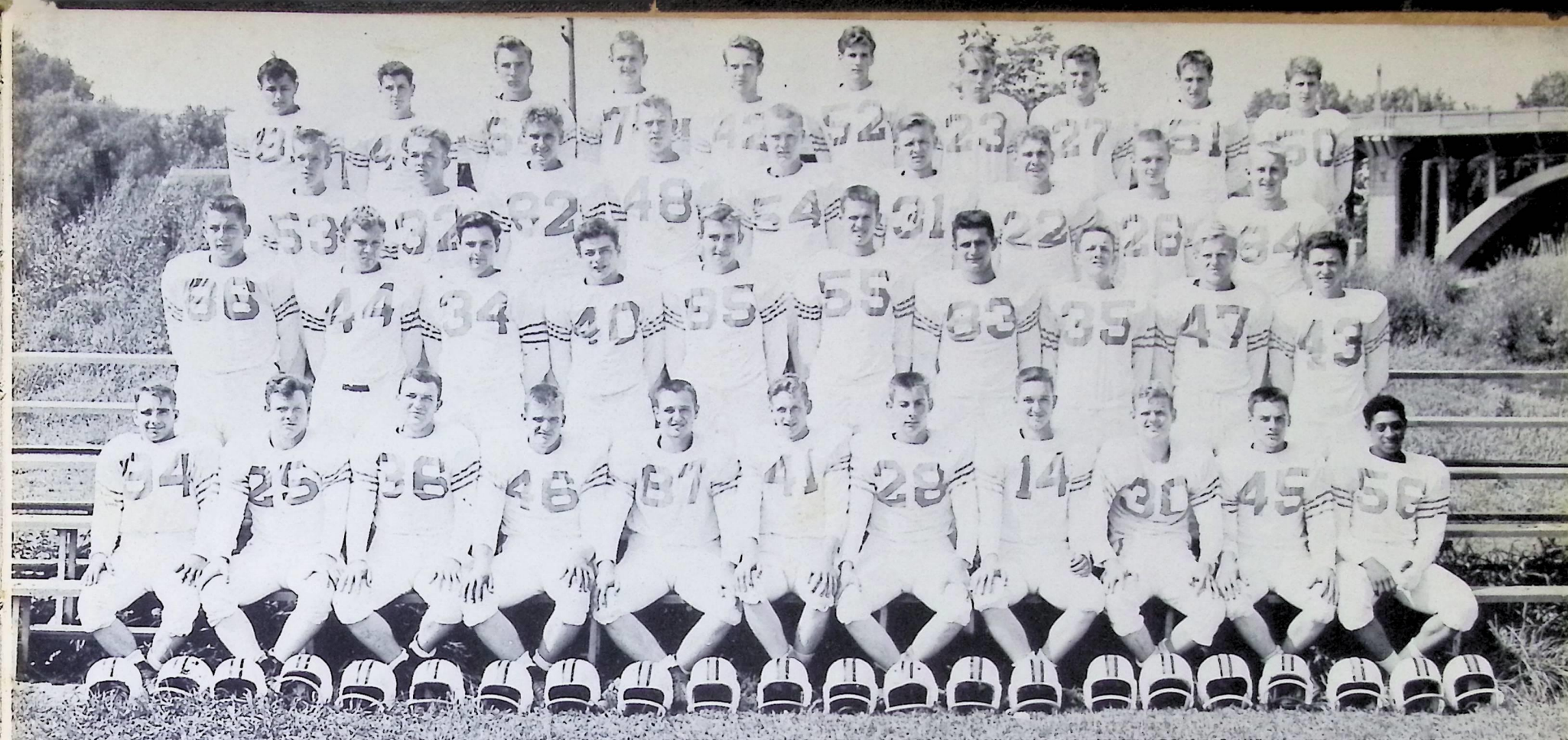

COACHES: J. Kost, H. Winters, S. Foster, K. Potter.

# FOOTBALL TEAM

Although the Ranger Gridders finished the season sharing the GCC cellar with Bedford, the year was not without its share of thrills and bright spots for Coach Harry Winters' stalwarts.

Among the latter was the selection of Varsity veteran Jim Rauker as All-Conference tackle, and Hal Hendershot and Ronnie Lang to the second team in end and tackle slots.

		Post Mortem	
WHS	20	Riverside	6
	32	Lutheran	6
	12	Garfield	44
	6	Maple Hts.	20
	7	Brush	13
	13	Bedford	13
	0	Berea	14
	2	Mentor	20



OUCH !



STOP THE MUSIC !



GETTING A HEAD

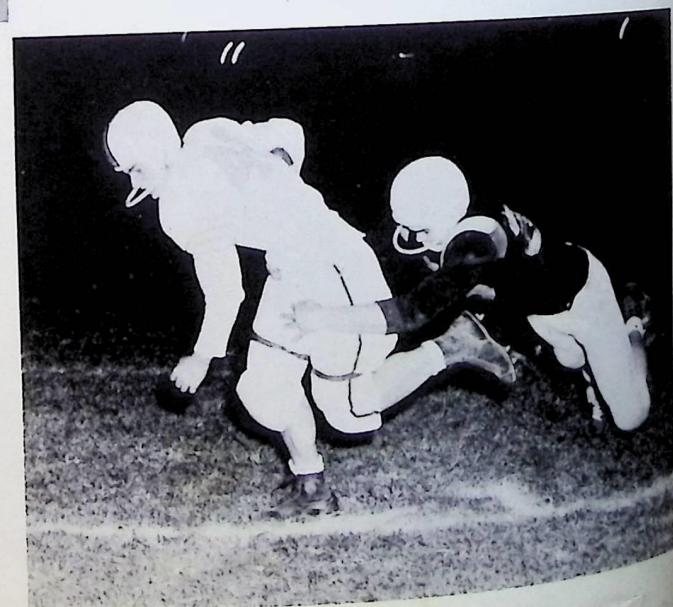

Go-----Go--- GO--GO--GO !



GET THAT MAN !



First Row: H. Hendershot, B. Floyd, J. Orick, E. Brott, D. Needham, D. Mullen. Second Row: J. Thompson, B. Wendell, D. Pelz, K. Bohnsack, J. Rauker.

COACHES: K. Potter, M. Cupp, C. Custer

## BASKETBALL TEAM



This year the Ranger Cagers finished in second place in the Greater Cleveland Conference, losing a heartbreaker to Bedford, 59 to 60. Dick Miller led the scoring race with 308 points in 18 games.

Willoughby dropped the tournament opener to Euclid, 55 to 53 in an overtime, another crushing loss. Dick Miller was chosen all-Tournament center for the Euclid District Tournaments.

Willoughby out-scored the opposition, 336 to 308.



GETTING A HEAD



STOP THE MUSIC !

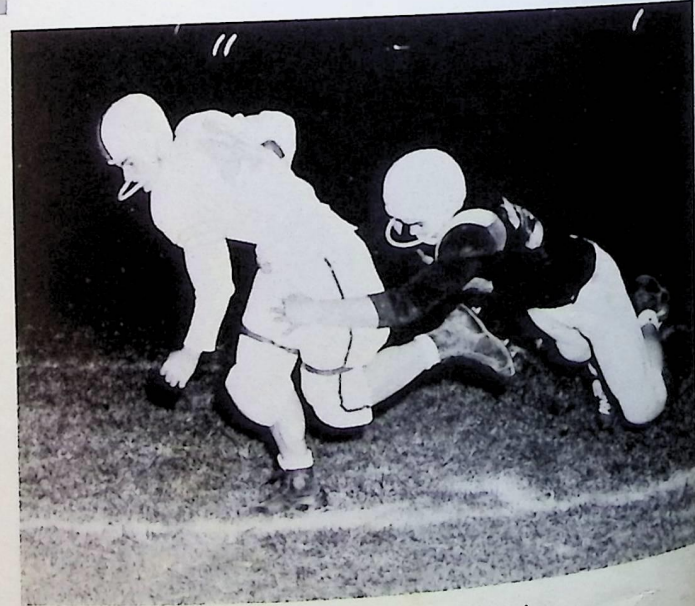

Go-----Go--- GO--GO--GO !



First Row: H. Hendershot, B. Floyd, J. Orick, E. Brott, D. Needham, D. Mullen. Second Row: J. Thompson, B. Wendell, D. Miller, D. Pelz, K. Bohnsack, J. Rauker.

COACHES: K. Potter, M. Cupp, C. Custer

# BASKETBALL TEAM



This year the Ranger Cagers finished in second place in the Greater Cleveland Conference, losing a heartbreaker to Bedford, 59 to 60. Dick Miller led the scoring race with 308 points in 18 games. Willoughby dropped the tournament opener to Euclid, 55 to 53 in an overtime, another crushing loss. Dick Miller was chosen all-Tournament center for the Euclid District Tournaments. Willoughby out-scored the opposition, 336 to 308.

### Conference Schedule

We	They	
62	Berea	57
50	Garfield	39
44	Maple	32
42	Brush	38
49	Bedford	51
68	Berea	69
64	Garfield	61
54	Maple	36
52	Brush	45
59	Bedford	60

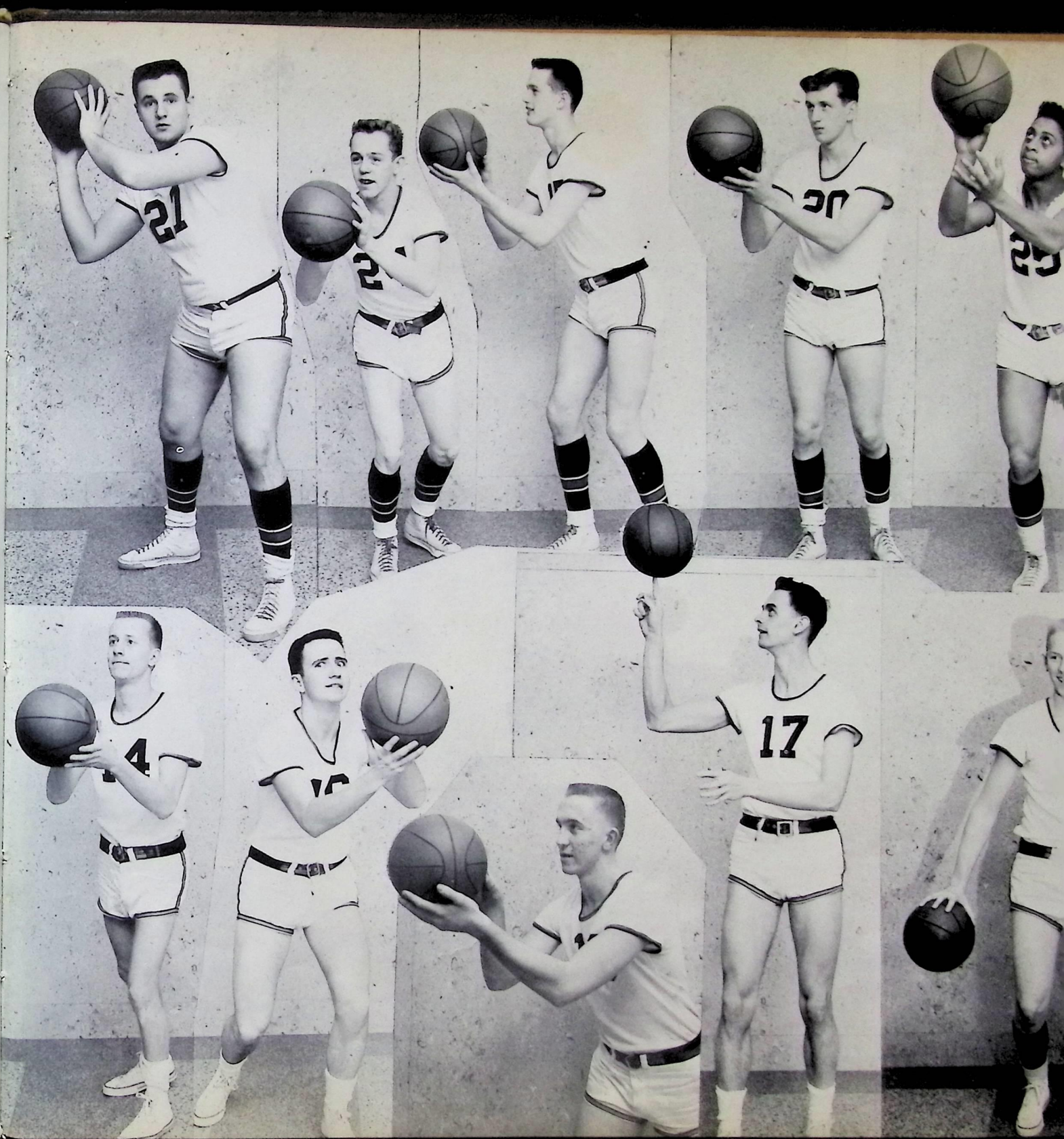
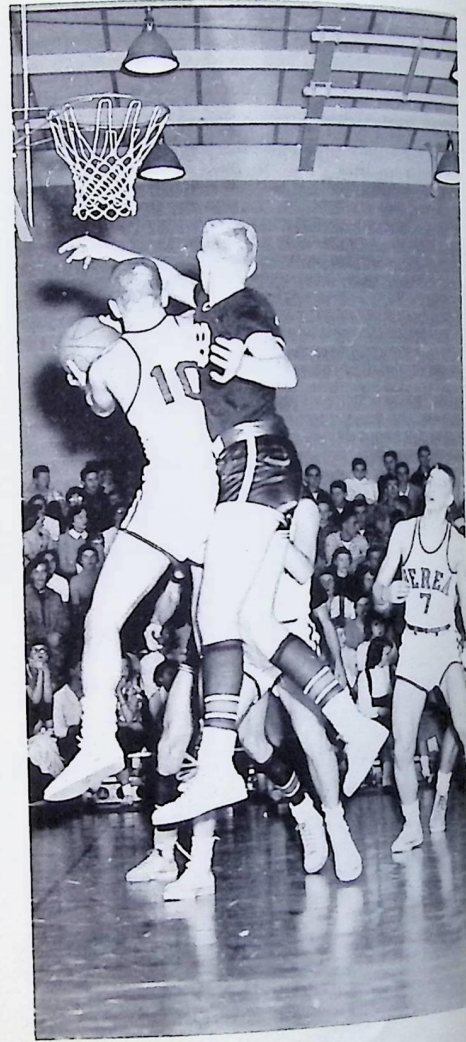
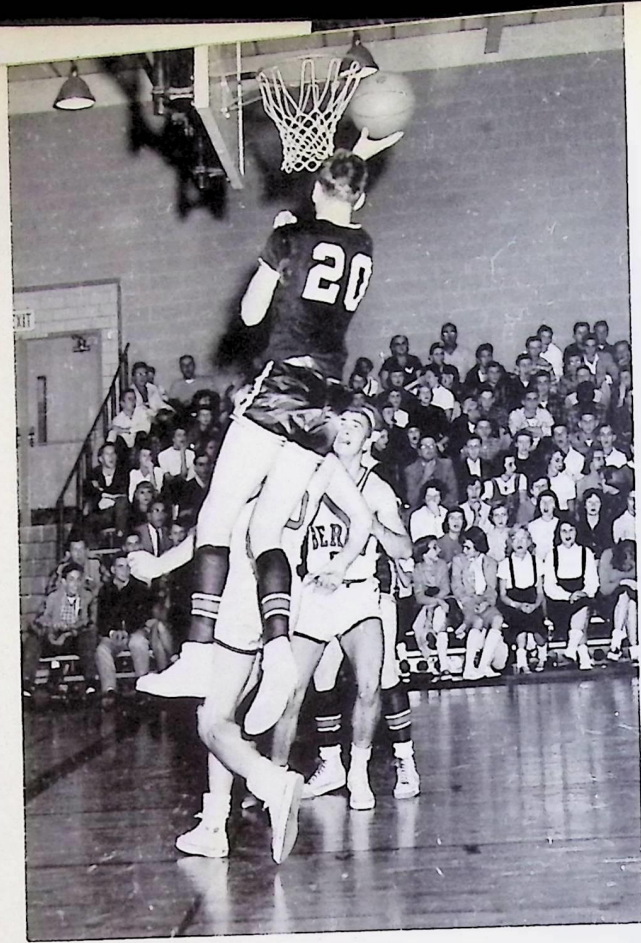



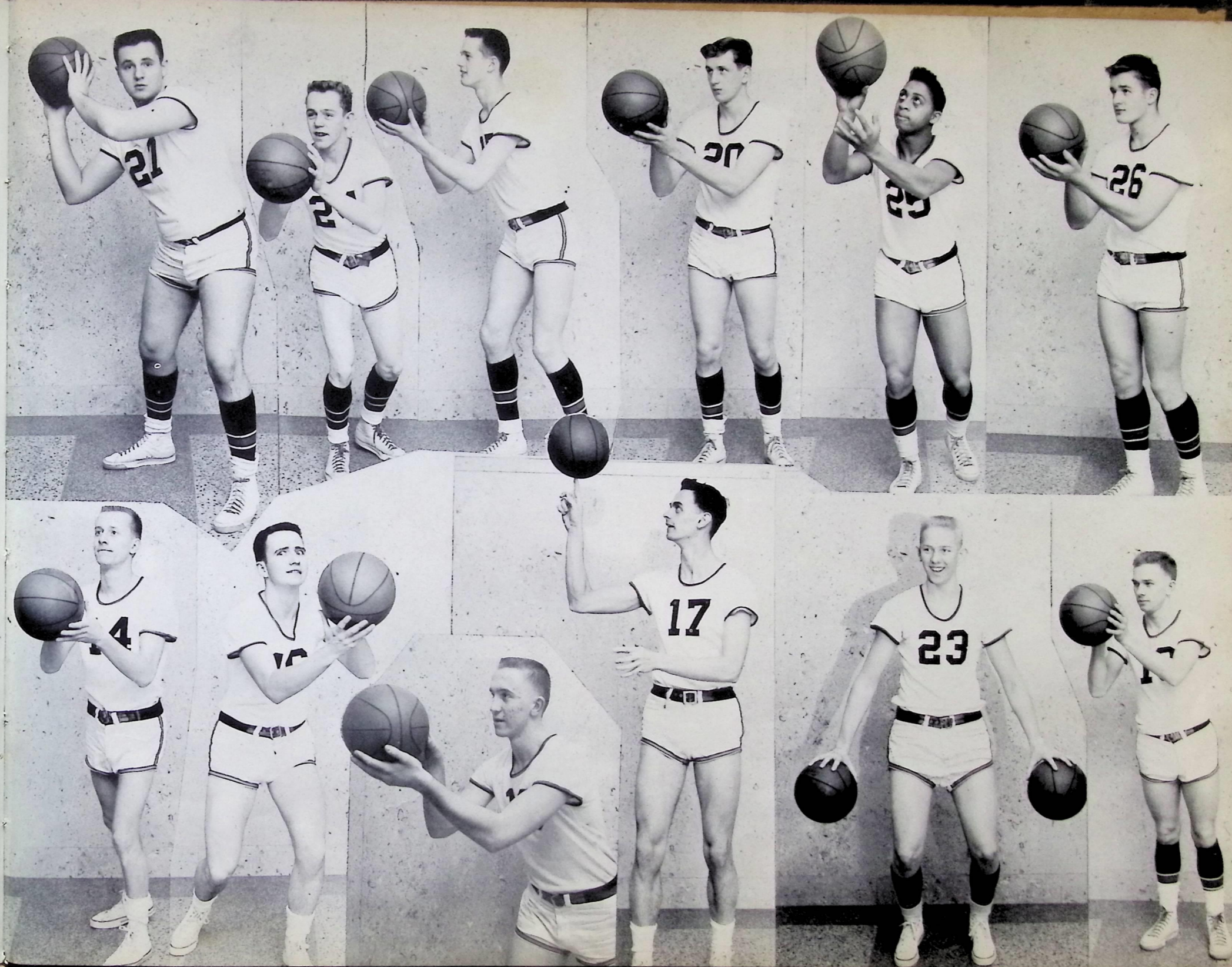
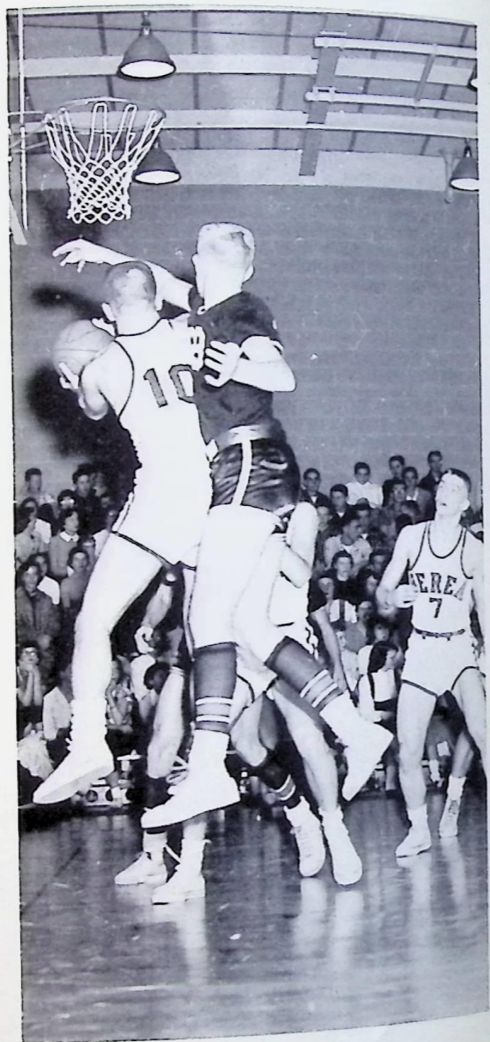
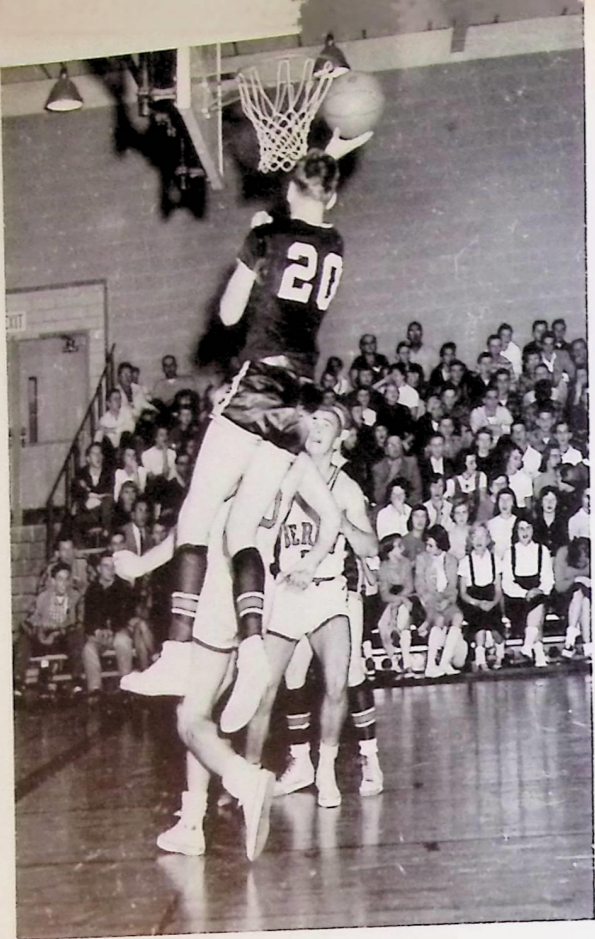

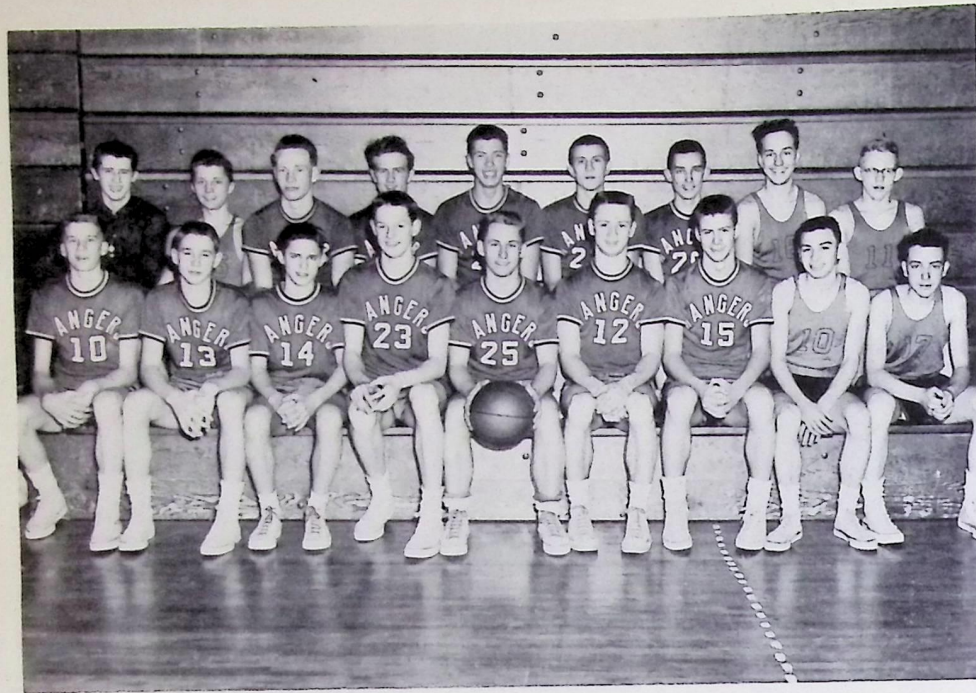

First Row: C. Sherk, B. Bourquard, J. Ptak, B. Wendell, J. Gasier, B. Doyle, T. Baller, J. Hipsher, B. Hamilton. Second Row: J. Bell, A. Barbian, B. Barrett, R. Sweeney, B. Pachnowski, A. Roth, T. Stell, D. Unger, D. Sealey.

MR. C. CUSTER, COACH



# J V U A N R I S O I T Y



The reserve team of the Rangers serves to acquaint the promising underclassmen with the why's and wherefore's of basketball. They have games before every varsity game, giving them both practice and experience in the face of the opposition. Those who show enough promise in the reserves are transferred to the varsity squad.

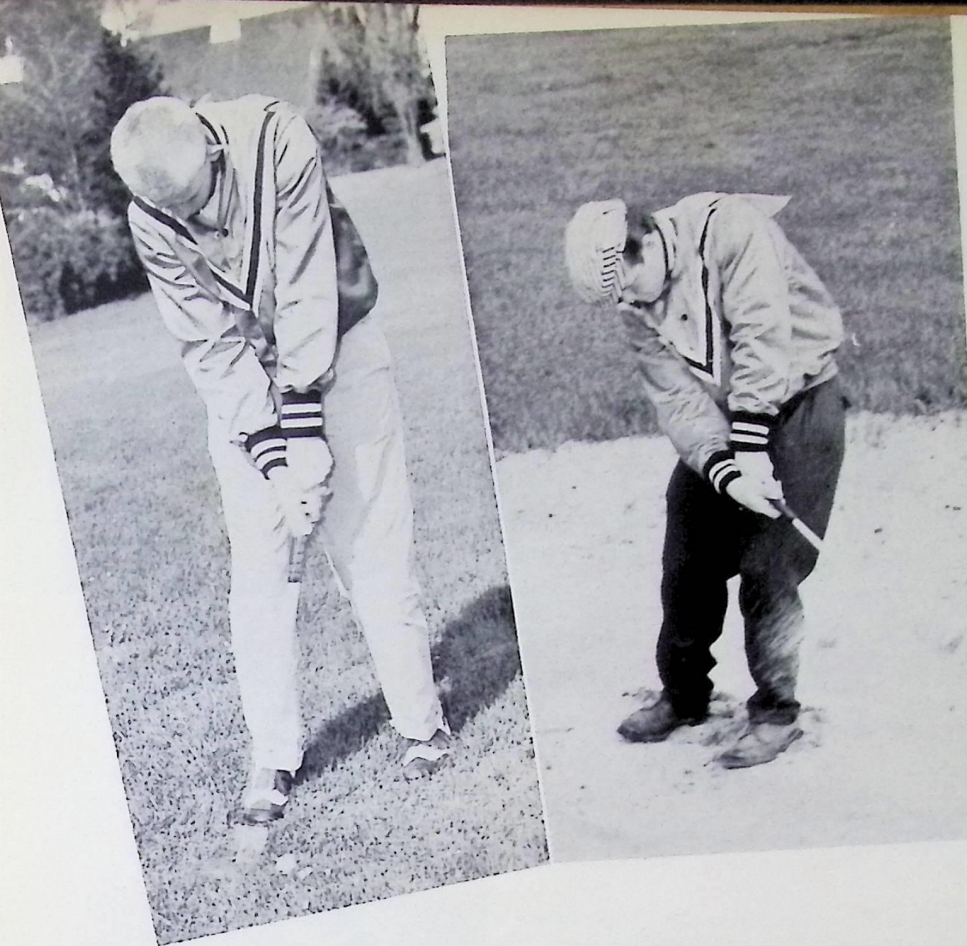

MR. C. WIKE, COACH



Mr. Wike J. Pizmoht

## RANGER GOLF TEA

This year, as they have for many years, Coach Chester Wike's Golfing Rangers putted around the Greater Cleveland Conference greens without losing a head-on-head match.

Jerry Pizmoht, medalist with 84, led the GCC tournament victory, and the Rangers ran their match play streak to beyond the century mark before finishing second and fourth in the Cleveland District and State tournaments.



Wendell, J. Gasier, B. Doyle, T. Baller, J. Hipsher, B. Barrett, R. Sweeney, B. Pachnowski, A. Roth, T. Stell,

J  
U  
N  
I  
O  
R  
S  
I  
T  
Y

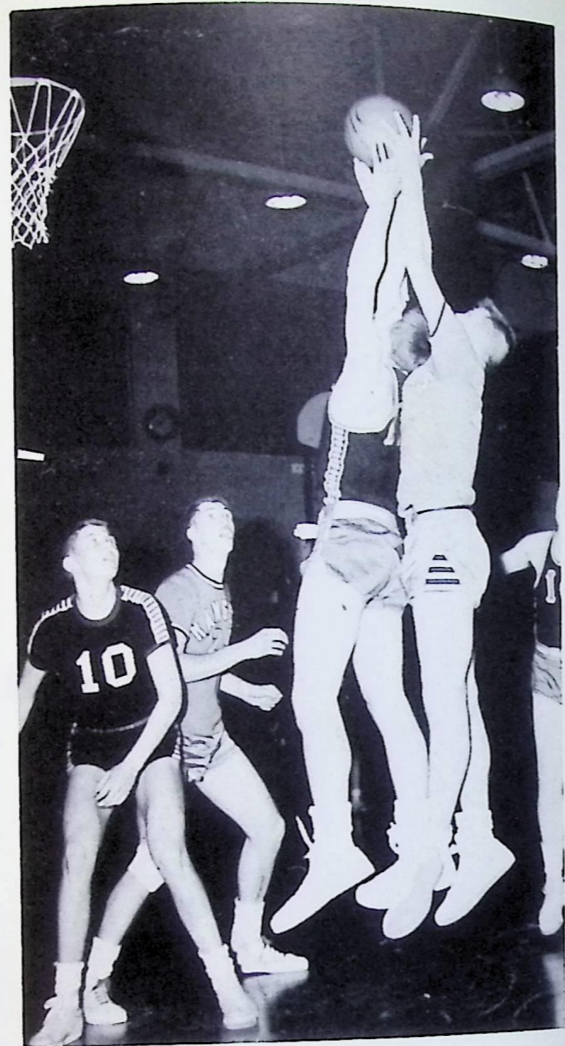

The reserve team of the Rangers serves to acquaint the promising underclassmen with the why's and wherefore's of basketball. They have games before every varsity game, giving them both practice and experience in the face of the opposition. Those who show enough promise in the reserves are transferred to the varsity squad.

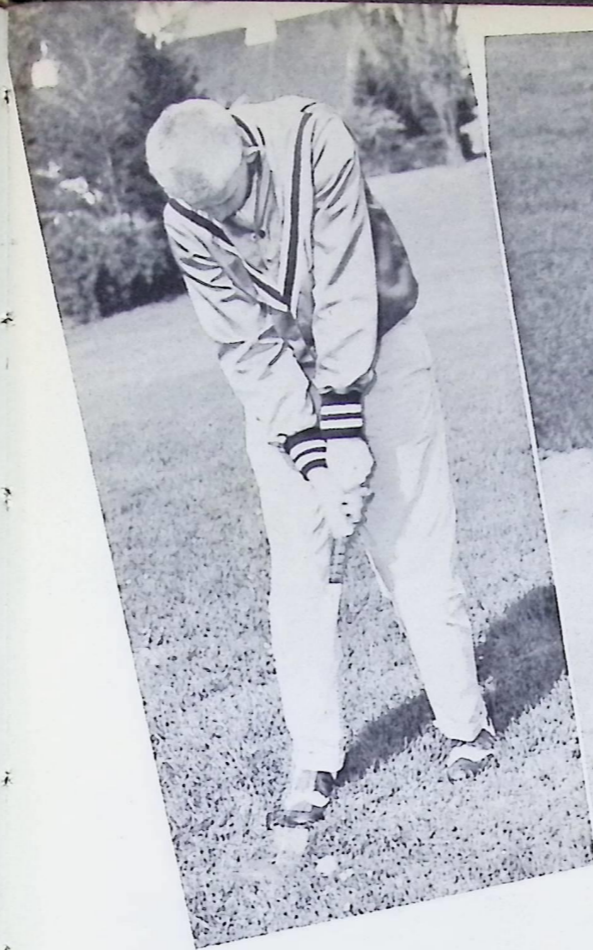

MR. C. WIKE, COACH

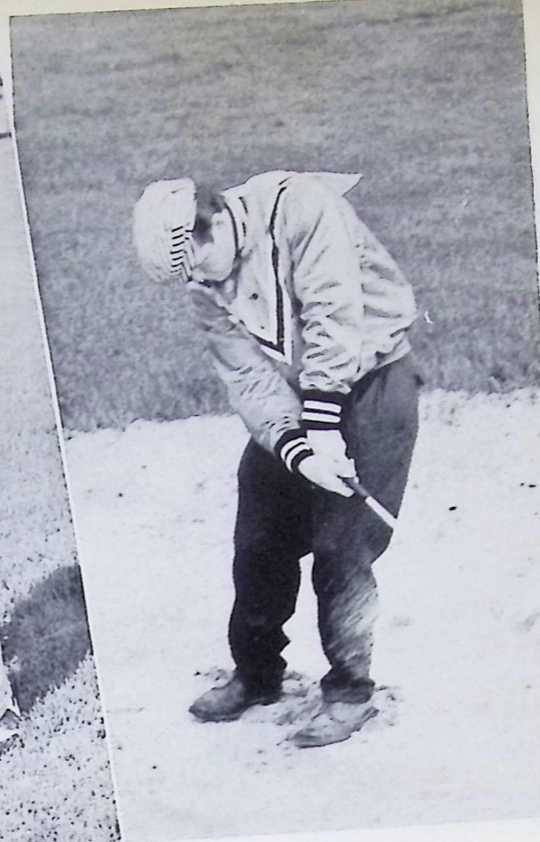

Mr. Wike J. Pizmoht C. Cook D. Pelz D. Lino R. Lang

## RANGER GOLF TEAM



This year, as they have for many years, Coach Chester Wike's Golfing Rangers putted around the Greater Cleveland Conference greens without losing a head-on-head match.

Jerry Pizmoht, medalist with 84, led the GCC tournament victory, and the Rangers ran their match play streak to beyond the century mark before finishing second and fourth in the Cleveland District and State tournaments.





Pole Vault, Tom Geiling



Relay: Bruce Wotring, Tim Tyler, Bob Doyle, Billy Floyd



Hurdles, Dick Miller.

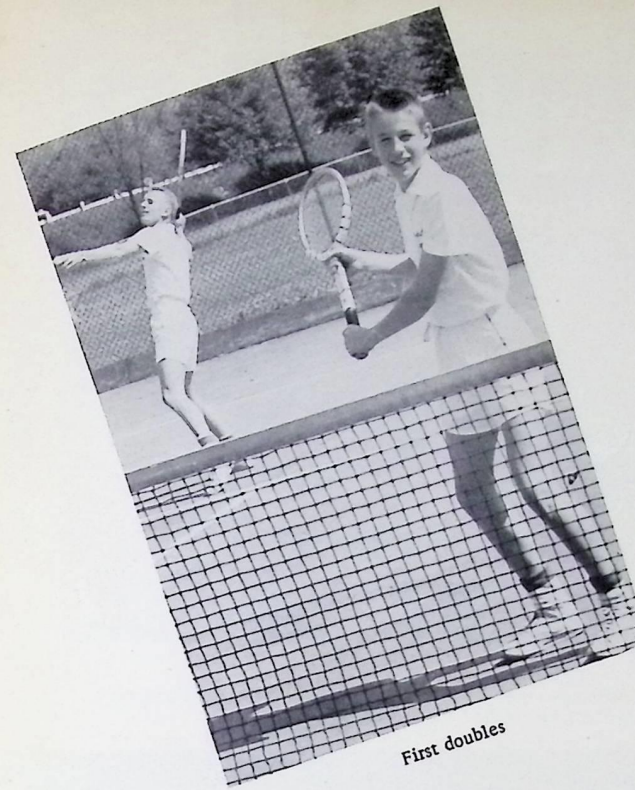

First doubles



Varsity men

# TRACK TEAM

JOHN KOST, COACH

In his first year as Willoughby High School track coach, John Kost developed an interesting and highly spirited team. The W. H. S. "Cindermen," high in competitive spirit compiled a winning record, scoring five wins while suffering three defeats.

The high spots of the season included a third place at the annual Mentor Relays and a fourth spot at the difficult Euclid Relays.

The Ranger record for 1956 was:

We	They	
11 1/2	Marion	106 1/2
66 1/2	Mentor	51 1/2
37 2/5	Maple Hts.	80 3/5
76	P. Harvey	42
78 1/2	Garfield Hts.	39 1/2
84 1/2	Brush	33 1/2
72 1/2	Bedford	45 1/2
46 1/3	Euclid	71 2/3



First Row: E. Richards, K. Hoffman, B. Floyd, J. Gasier, J. Orick, T. Geiling, L. Neeld. Second Row: P. Bolthauzer, B. Doyle, J. Fickes, B. Wotring, R. Sweeney, T. Tyler. Third Row: J. Kost, D. George, J. Thompson, R. Francis, D. Stupor, J. Mursencavage, D. Cox. Fourth Row: T. Whittington, D. Hunter, J. Rauker, W. Tring, A. Hoge, A. Pollard.

# TENNIS TEAM

KEN POTTER, COACH

The 1956 Ranger tennis squad marked the school's third entry in interscholastic racquet competition, but the record belies their "youth."

Coach Ken Potter's boys won all their regular league games but to Shaker Heights in the city playoffs. In independent play, the squad won three out of four, losing only to crackerjack Cleveland Heights. There was another but no-count loss, an exhibition defeat at the hands of Muskingham College, 5 to 2.

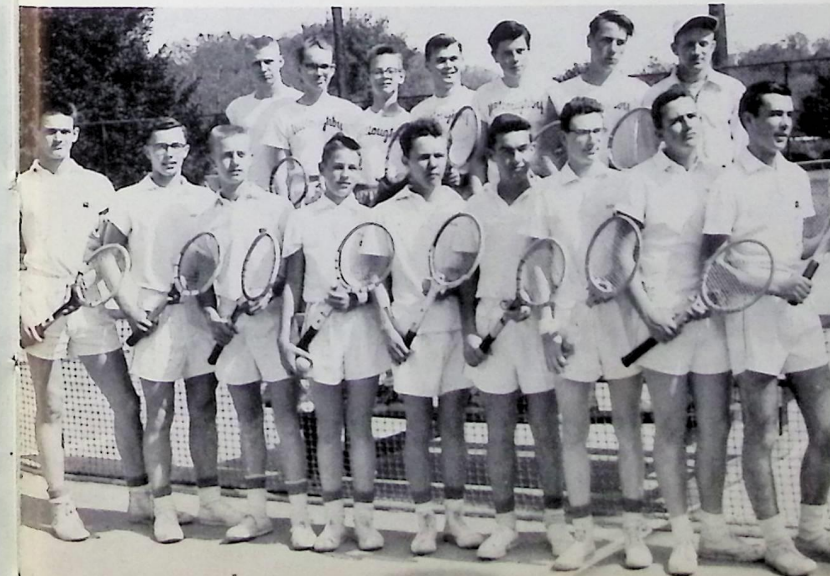



Relay: Bruce Woring, Tim Tyler, Bob Doyle, Billy Floyd



Hurdles, Dick Miller.

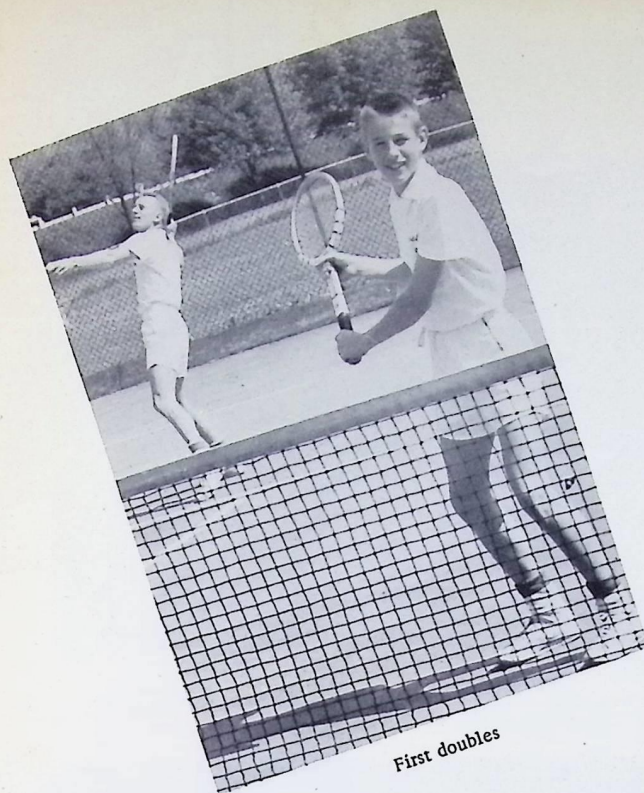

First doubles



Varsity men

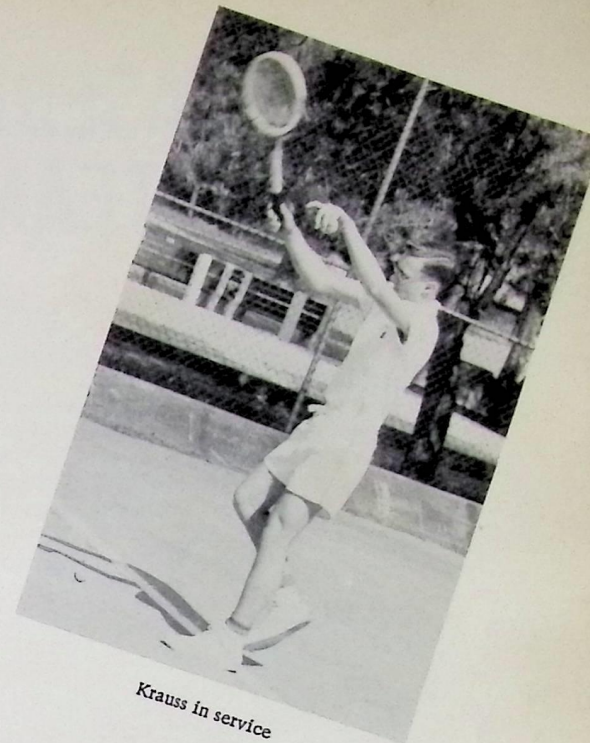

Krauss in service

# TRACK TEAM

JOHN KOST, COACH

In his first year as Willoughby High School track coach, John Kost developed an interesting and highly spirited team. The W. H. S. "Cindermen," high in competitive spirit compiled a winning record, scoring five wins while suffering three defeats.

The high spots of the season included a third place at the annual Mentor Relays and a fourth spot at the difficult Euclid Relays.

The Ranger record for 1956 was:

We	They	
11 1/2	Marion	106 1/2
66 1/2	Mentor	51 1/2
37 2/5	Maple Hts.	80 3/5
76	P. Harvey	42
78 1/2	Garfield Hts.	39 1/2
84 1/2	Brush	33 1/2
72 1/2	Bedford	45 1/2
46 1/3	Euclid	71 2/3



Orick, T. Geiling, L. Neeld. Second Row: y, T. Tyler. Third Row: J. Kost, D. George, Cox. Fourth Row: T. Whittington, D. Hunter,

# TENNIS TEAM

First Row: B. Wendell, C. Krauss, D. Needham, B. Bourquard, B. Bilton, D. Porter, A. Edgell, D. Mullen, D. Kurrle. Second Row: J. Berndt, B. Hamilton, B. Papes, A. Hughes, D. Humphrey, B. Miller, K. Potter, Coach.

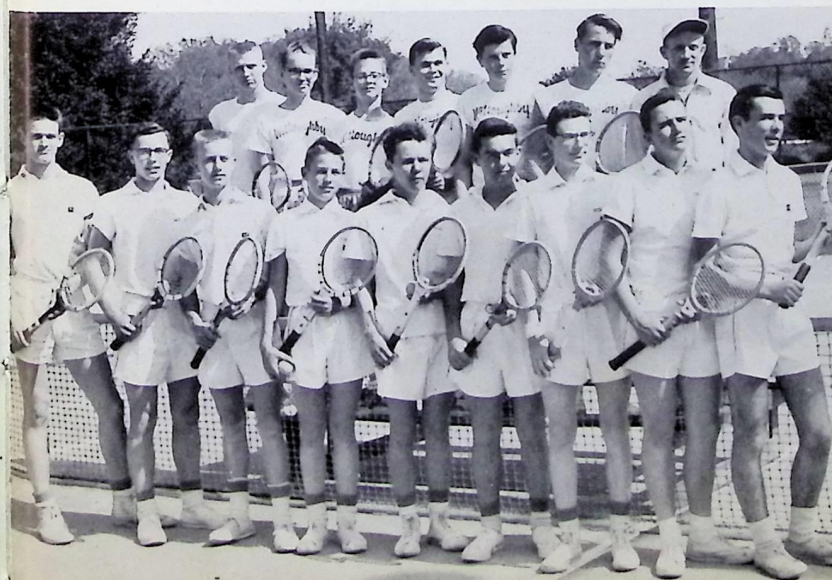

The 1956 Ranger tennis squad marked the school's third entry in interscholastic racquet competition, but the record belies their "youth."

Coach Ken Potter's boys won all their regular league games but to Shaker Heights in the city playoffs. In independent play, the squad won three out of four, losing only to crackerjack Cleveland Heights. There was another but no-count loss, an exhibition defeat at the hands of Muskingham College, 5 to 2.

KEN POTTER, COACH



Follow through

# BASEBALL TEAM

Despite the fact that only three lettermen returned to diamond warfare in 1956, Coach Stan Foster's Rangers captured the Greater Cleveland Conference for the fifth time in six years, compiling as they did, a 9-1 league record.

Winning individual honors for the high-riding team was Doug Pringle, who took over the lion's share of the pitching duties and won a place for himself on All-Conference, All-Scholastic, and All-State teams. Also winning distinction were shortstop Hal Hendershot, second basemen George Korpi, and outfielder John MacIlwaine.

### Post Mortem

<u>We</u>	<u>They</u>
4	Maple Hts. 1
8	Brush 2
8	Bedford 6
14	Berea 2
7	Garfield Hts. 0
3	Maple Hts. 1
7	Brush 4
0	Bedford 5
12	Berea 4
14	Garfield Hts. 6

Managers: Tom Sizer, Henry Wilson



### VARSITY

Front: Stan Foster, Tom Sizer. Back: T. Heymeyer, G. Korpi, B. Ronniger, C. Loach, H. Hendershot, B. Baughman, D. Pringle, J. MacIlwaine, J. Matz, C. Sturm.



### JUNIOR VARSITY

First Row: C. Price, R. Miller, C. Reed, J. Carroll, R. Spohn, B. Pachnowski, T. Baller, J. Stois. Second Row: Mr. Cupp, C. Estes, J. Hipsher, C. Shenk, J. Lattimore, E. Brott, D. Marsh, S. Lambo.

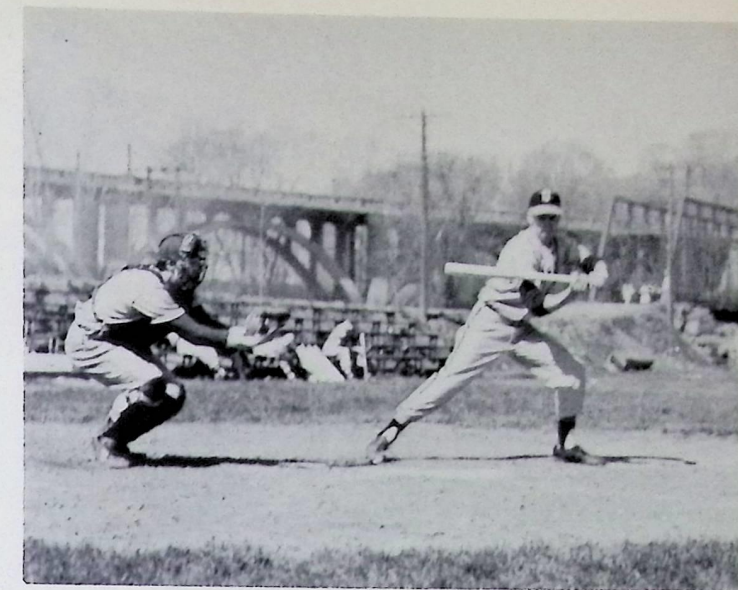

Where's the ball?

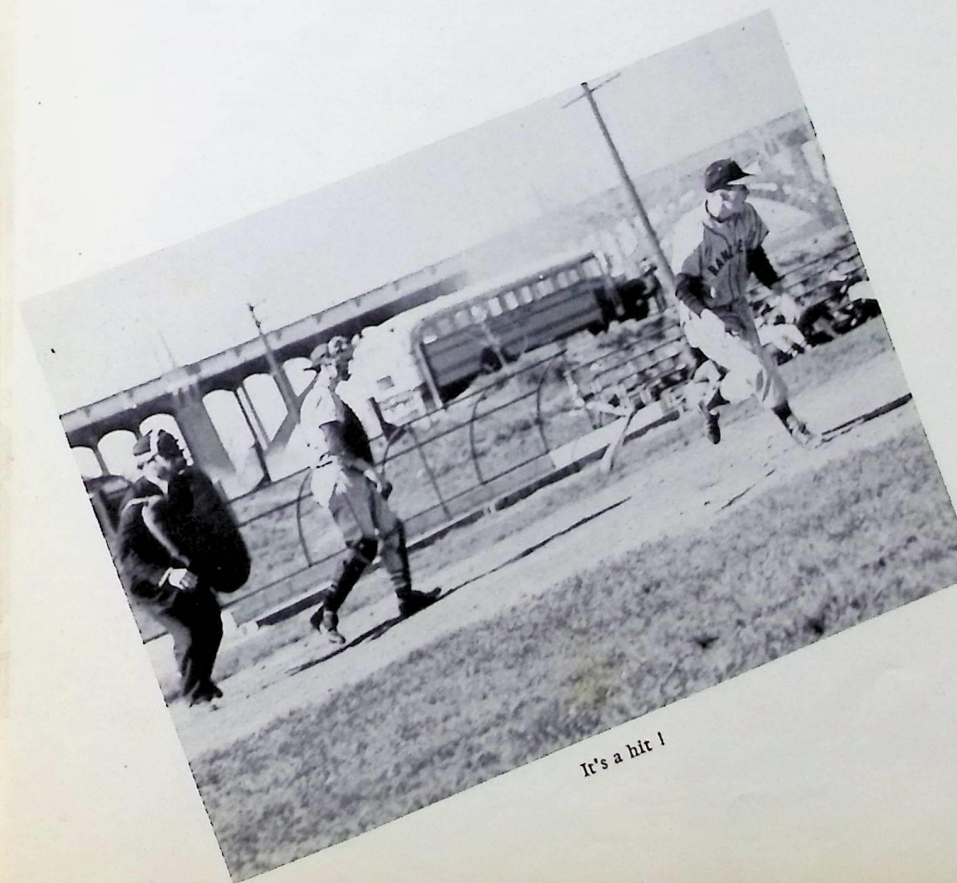

It's a hit!



You're Out!

# ALL M

Aftermen returned to diamond  
Rangers captured the Greater  
one in six years, compiling as

high-riding team was Doug  
e of the pitching duties and  
ence, All-Scholastic, and  
ction were shortstop Hal  
Korpi, and outfielder John

m



**VARSITY**  
Front: Stan Foster, Tom Sizer. Back: T. Heymeyer, G. Korpi, B. Ronniger, C. Loach, H. Hendershot,  
B. Baughman, D. Pringle, J. MacIlwaine, J. Matz, C. Sturm.

They	
Maple Hts.	1
Brush	2
Bedford	6
Berea	2
Garfield Hts.	0
Maple Hts.	1
Brush	4
Bedford	5
Berea	4
Garfield Hts.	6



**JUNIOR VARSITY**  
First Row: C. Price, R. Miller, C. Reed, J. Carroll, R. Spohn, B. Pachnowski, T. Baller, J. Stojs. Second  
Row: Mr. Cupp, C. Estes, J. Hipsher, C. Shenk, J. Lattimore, E. Brott, D. Marsh, S. Lambo.

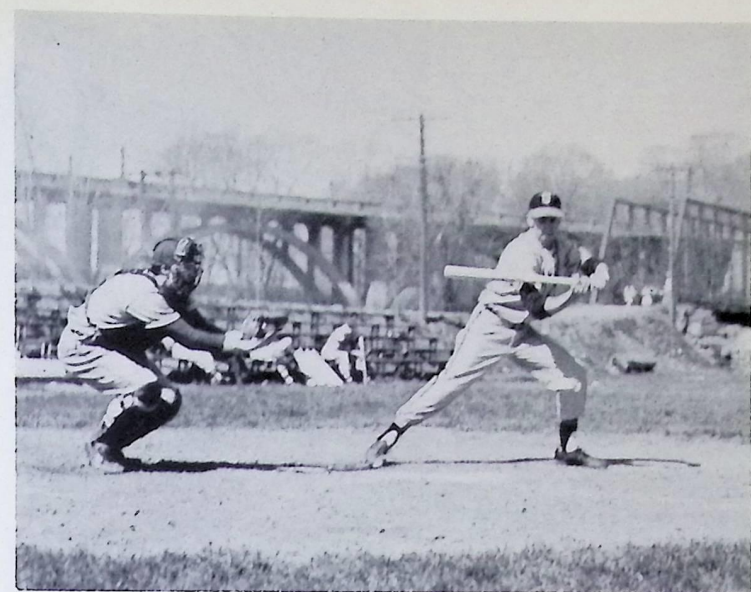

Where's the ball?

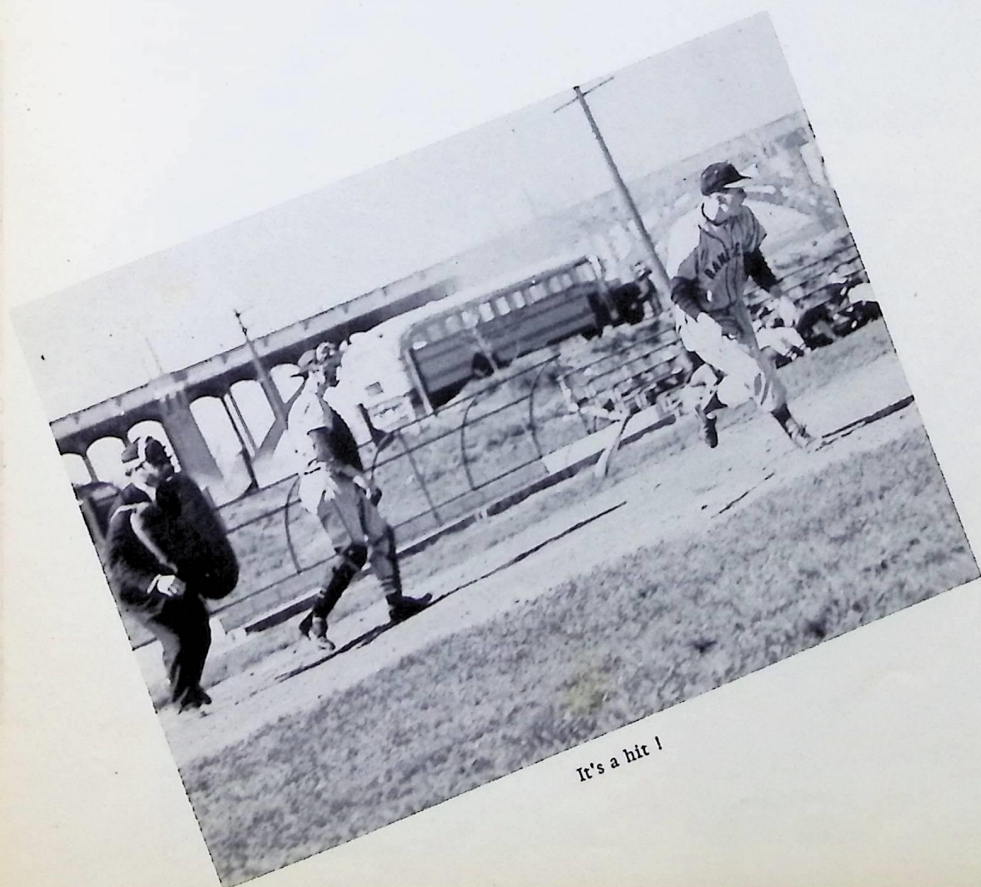

It's a hit!

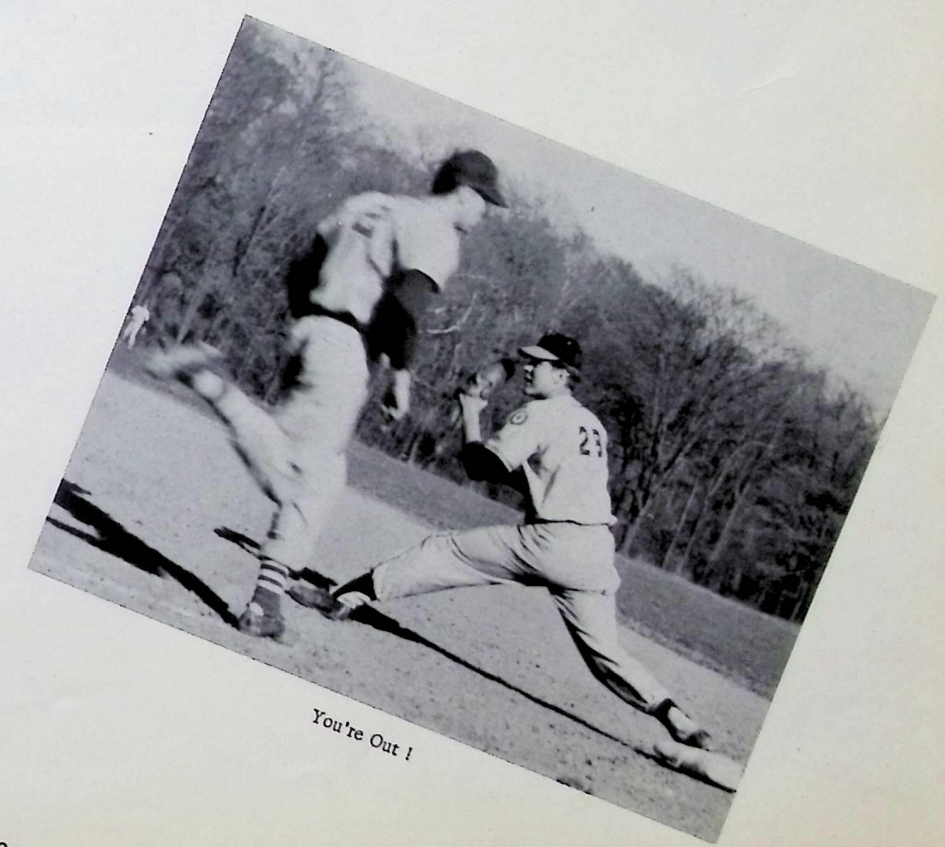

You're Out!

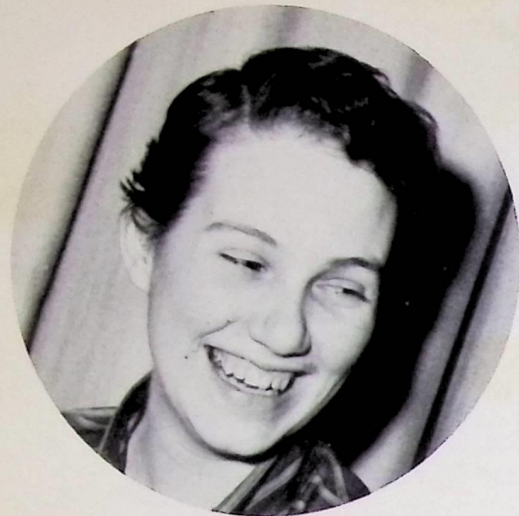

DONNA HOGG, MANAGER

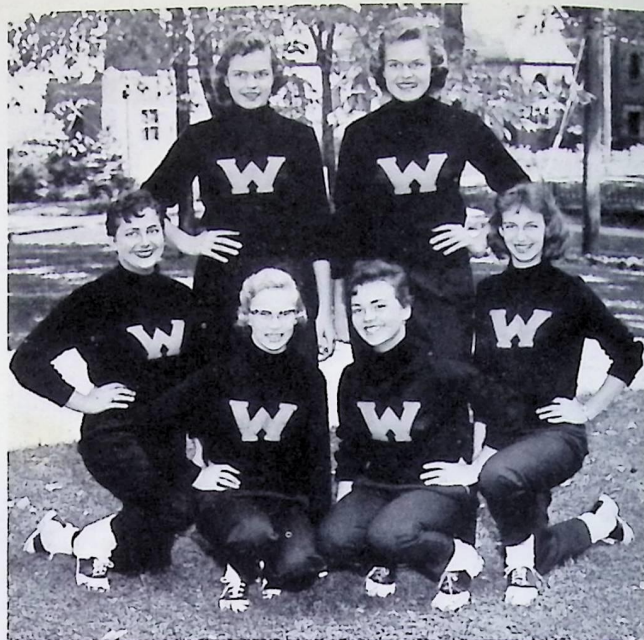

JUNIOR VARSITY

J. Lasko, E. Pirkola, P. Greer, J. Ling, J. Cooke, A. Cooke



PAT

ANITA

PHYL

JUDY

ANN

LINDA

# CHEERLEADERS

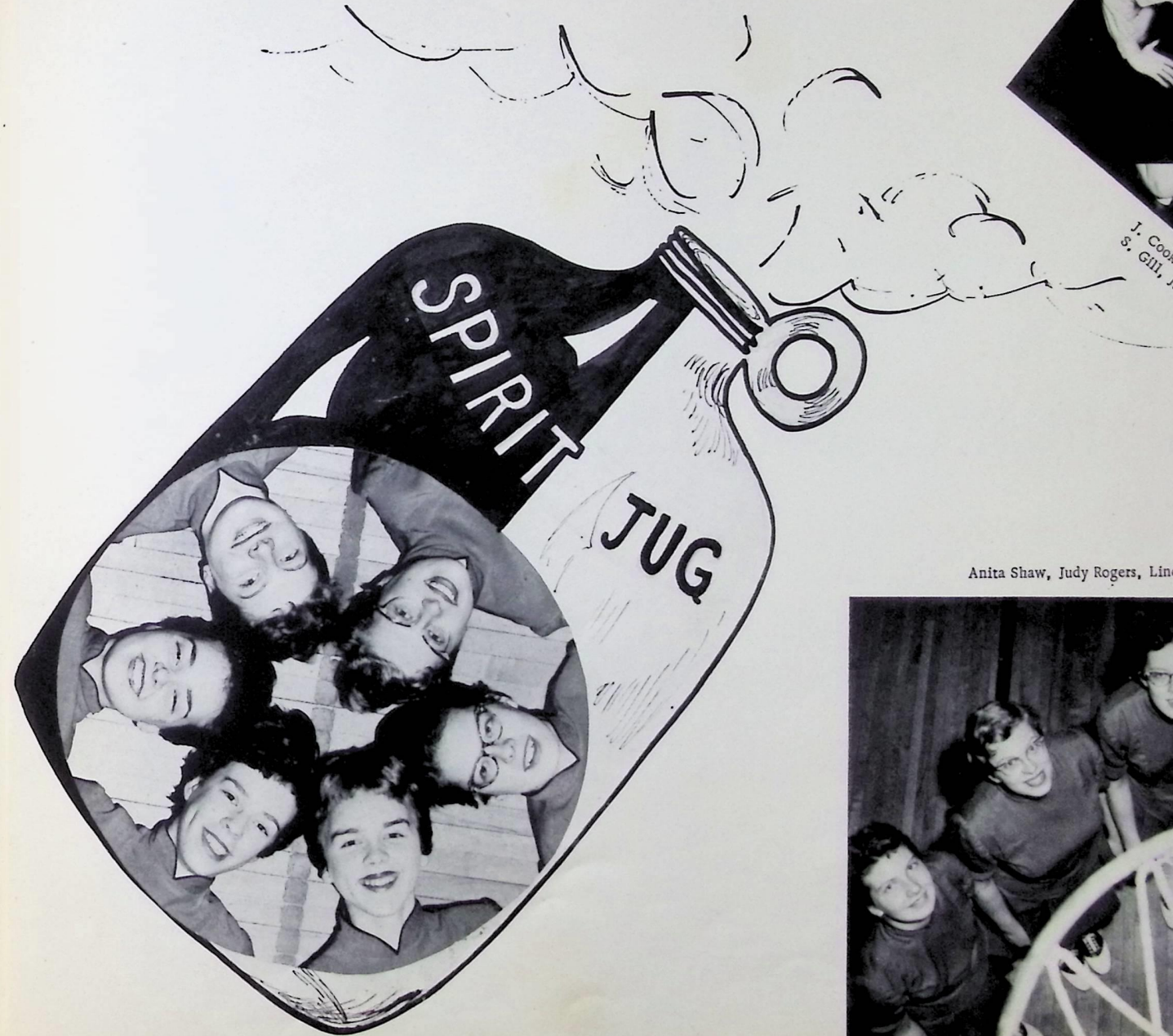

Anita Shaw, Judy Rogers, Linda







JUNIOR VARSITY  
 J. Lasko, E. Pirkola, P. Greer, J. Ling, J. Cooke, A. Cooke



ANITA      PHYL      JUDY      ANN      LINDA

# CHEERLEADERS

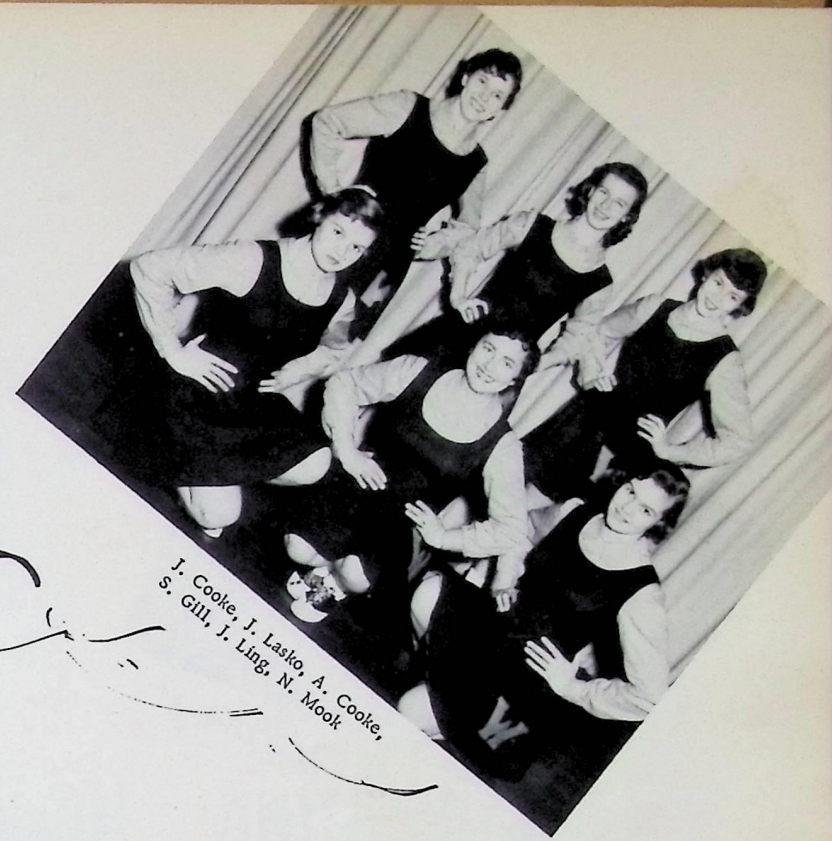
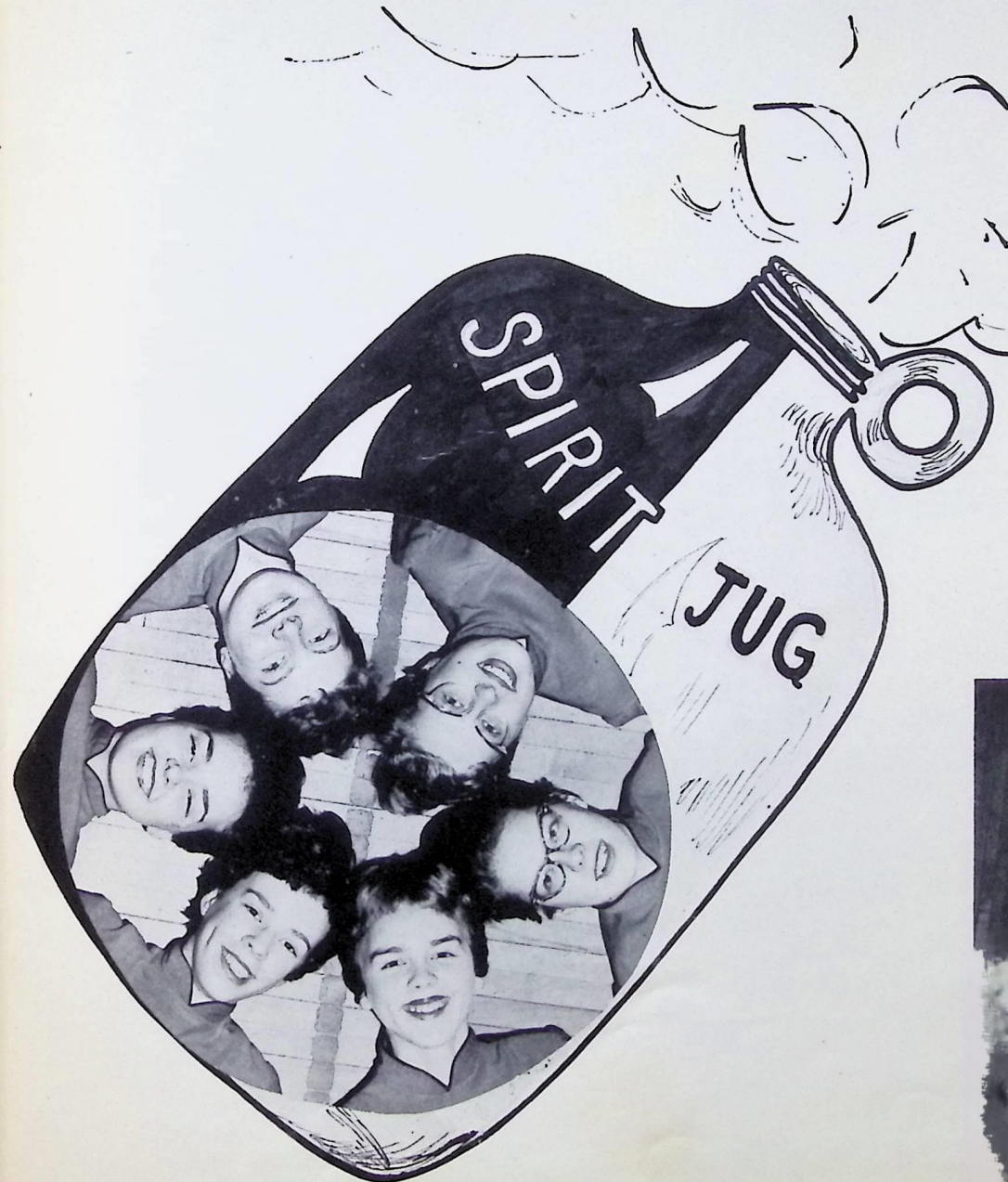

J. Cooke, J. Lasko, A. Cooke,  
 S. Gill, J. Ling, N. Mook

Anita Shaw, Judy Rogers, Linda Thomas, Ann Alpeter, Phyllis Patterson, Pat Greer

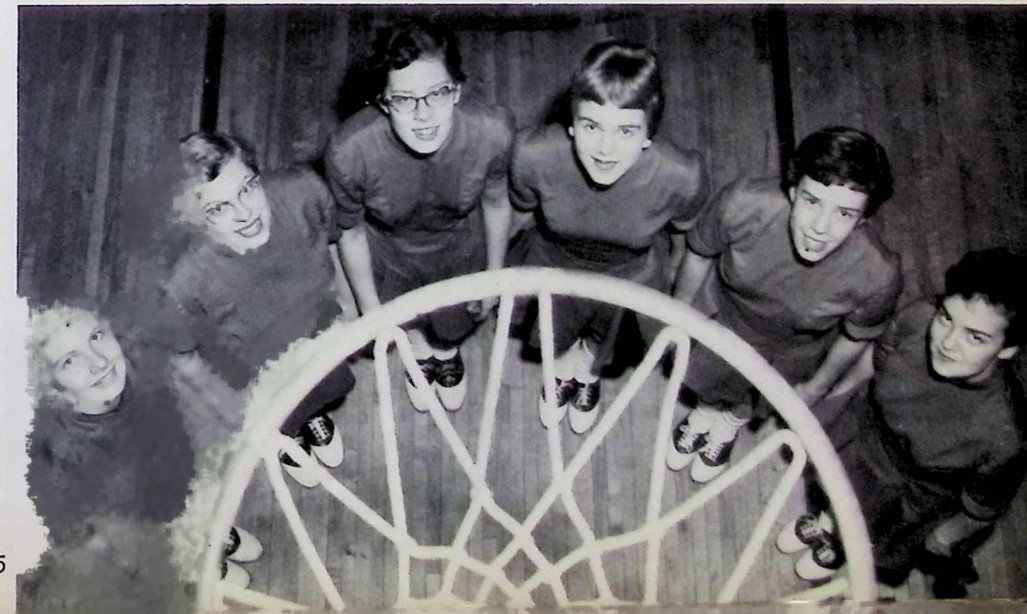



*Carolyn Blazyn*



*Cindy Bouton*



*Sally Farnan*

# HOMECOMING COURT

*Suzanne Bengt*



*Donna Hogg*



*Nicky Rippens*



*Anita Shaw*

The  
High Sch  
ing of pr  
court reig  
tured in



*Cindy Bouton*



*Sally Farran*

**HOMECOMING COURT**



*Neely Rippens*



*Donna Hoag*



*Anita Shaw*

**HOME  
COMING  
QUEEN**

**ANITA SHAW**

The Homecoming celebration held at Willoughby High School this year was highlighted with the crowning of pretty Anita Shaw as queen. Anita and her court reigned over the many activities which are featured in Willoughby's annual Homecoming weekend.

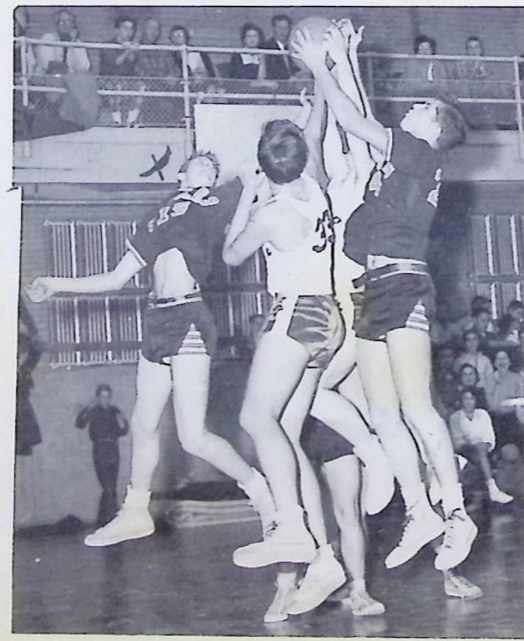
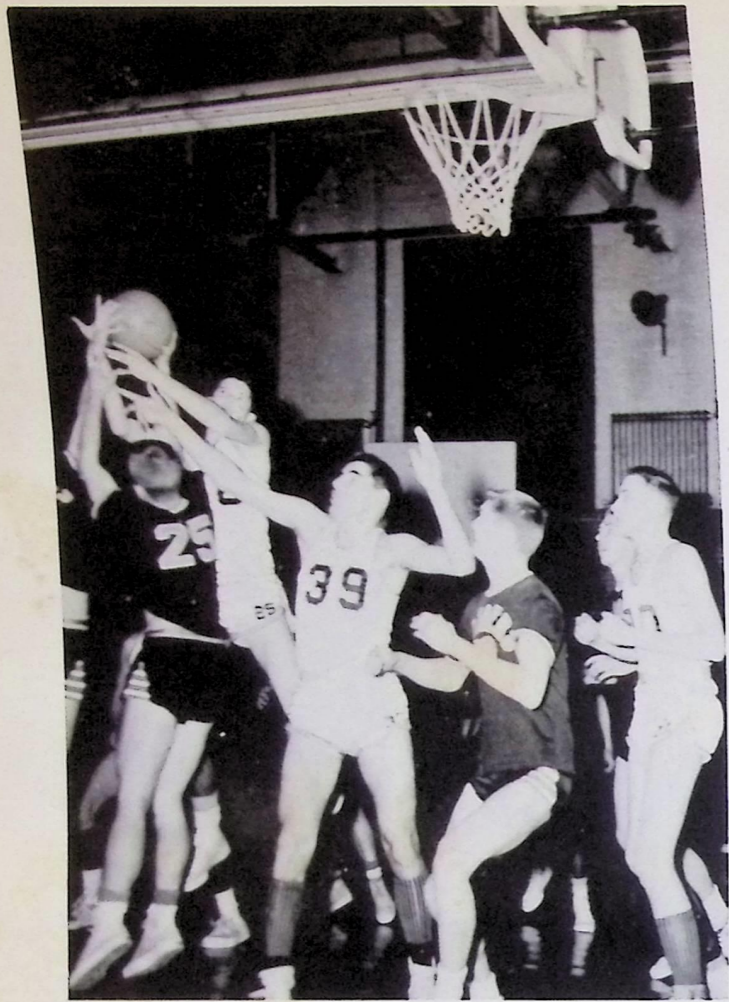

# ADVERTISEMENTS



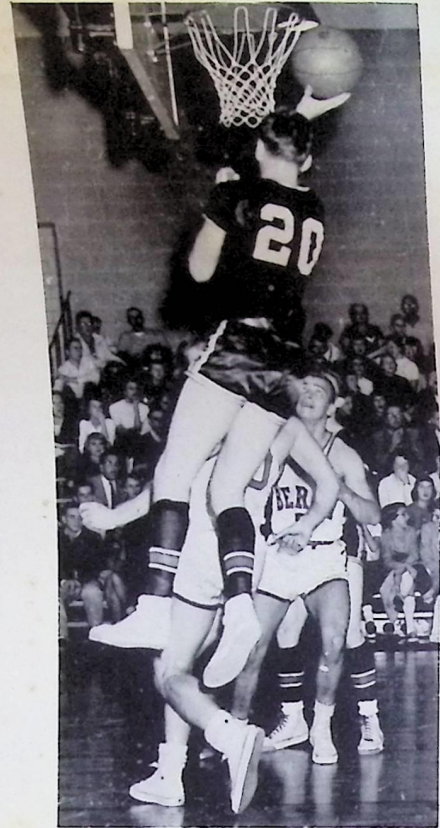

# ADVERTISEMENTS

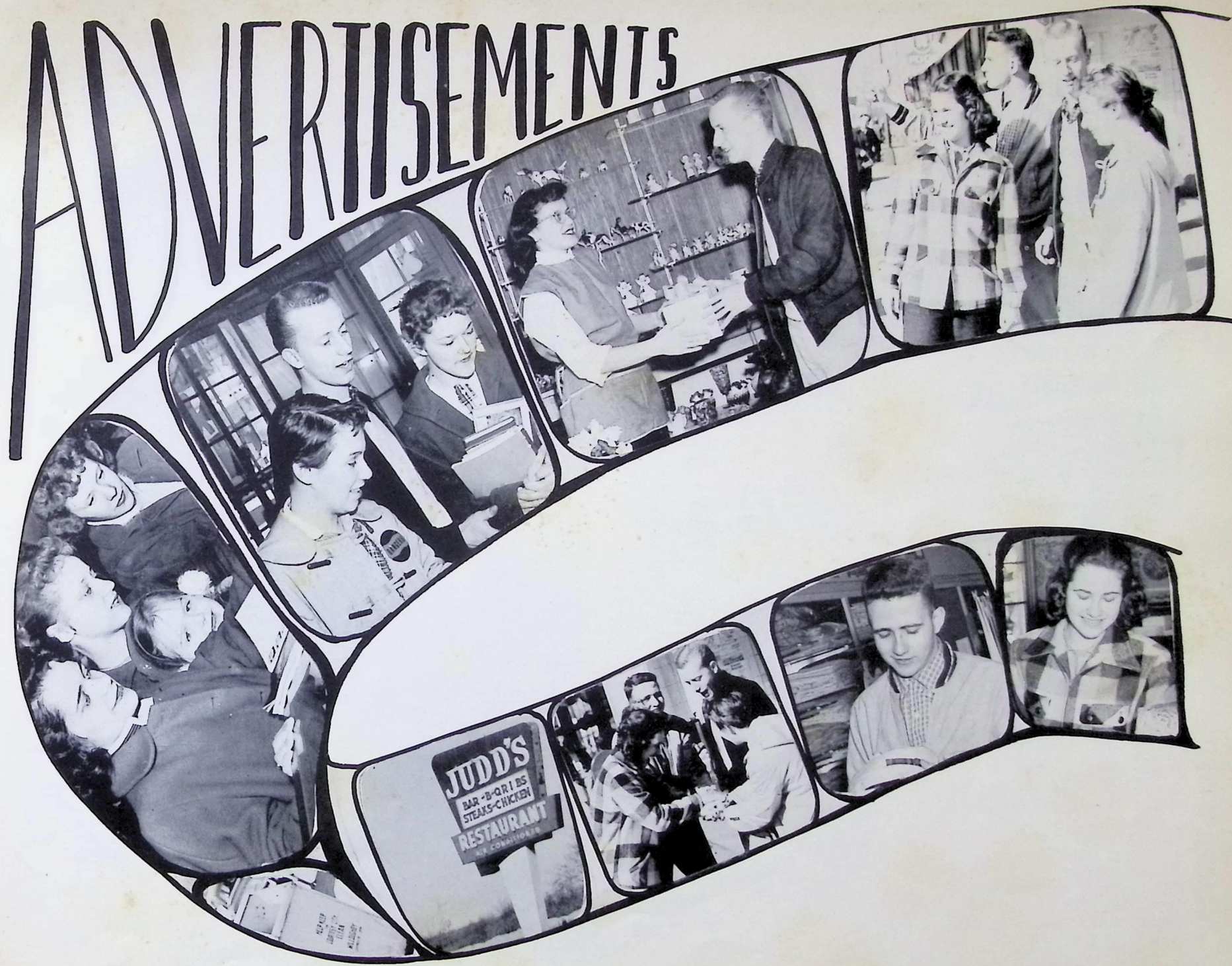

## WILLOUGHBY CONSOLIDATED CHARITY AND SERVICE FUND

This fund sponsored by the Willoughby Chamber of Commerce

### LARGE INDUSTRY

THE OHIO RUBBER COMPANY  
THOMPSON PRODUCTS, INC.

### MEDIUM INDUSTRY

BARIUM & CHEMICALS, INC.  
VICTOR BROWNING CO.  
ECONOMY ENGINEERING CO.  
FEEDALL ENGINEERING  
KENNAMETAL INC.  
REIGHART STEEL  
S. S. PARSONS ENGINEERING  
SHERATON FURNITURE

### SMALL INDUSTRY

ALPHA PRODUCTS, INC.  
PATT BROS.  
WILLO-HILLS INDUSTRIES  
WILLOUGHBY SCREW MACHINE  
PRODUCTS  
WILLOUGHBY MACHINE CO., INC.

### LARGE BUSINESS

CLEVELAND ELECTRIC  
ILLUMINATING CO.  
CLEVELAND TRUST CO.  
EAST OHIO GAS CO.  
FIRST FEDERAL SAVINGS & LOAN  
LAKE COUNTY NATIONAL BANK  
OHIO BELL TELEPHONE CO.

### LARGE MERCANTILE OR SERVICE

FISHER BROS. CO.  
GLASSCOCK CHEVROLET CO.  
GREAT ATLANTIC & PACIFIC  
TEA CO.  
LAIRD LUMBER CO.  
NEWS HERALD  
STANDARD OIL  
WILLOUGHBY MOTORS INC.  
VINE THEATER  
WILLOUGHBY HARDWARE CO.  
F. W. WOOLWORTH CO.

### MEDIUM MERCANTILE OR SERVICE

AMERICAN FRUIT GROWERS PUB. CO.  
BAKER DRUG  
BEEBOWER BROS. FEED & SUPPLY  
BENSON'S STORE FOR MEN  
CITY LOAN & SAVINGS CO.  
CLINGER MOTOR SALES, INC.  
COCHRAN, J. P. CO.  
COLEMAN-YOUNG MOTORS  
DANIELS BROS. FUEL CO.  
FAIRLEY & GRESSEL FOODS  
GENERAL AVIATION INC.  
GOFF KIRBY CO.  
H & J HARDWARE  
HARDGROVE REALTY  
HERMAN'S DRY CLEANING  
HOGAN PACKARD  
JOSEPH SHOES, INC.  
KENYON FURNITURE  
KINTER BROS.  
LAKE SHORE LUMBER CO.  
LEADER'S TRAILER PARK  
LOU'S FIRESTONE  
MEIL'S DEPARTMENT STORE  
MODERN SHOE STORE  
PAINESVILLE TELEGRAPH  
SEIPP OLDSMOBILE CO.  
SIMON, H. F. STORE  
SMITH, J. A. & SON  
SNYDER FURNITURE  
STURMS FOOD MARKET  
TOWNE & COUNTRY TV APPLIANCES  
WAREHOUSE BEVERAGE STORE  
WILLOUGHBY AUTO ACCESSORIES  
WILLOUGHBY FASHION SHOP  
WILLOUGHBY TERMINALS CO.  
WRIGHTS DEPARTMENT STORE

### SMALL MERCANTILE OR SERVICE

BARNES SEED & SUPPLY CO.  
BEVERLY FROCKS  
BRANDT CANDY KITCHEN  
BRICHFORD SHELL SERVICE  
CARROLL'S SWEET SHOP  
CLARK & PIKE CO.  
COTTRELL'S NEWS STAND  
DAINTEE BEAUTY SHOP  
DAV-ED JEWELERS  
DISBRO, R. M. INSURANCE  
DOT RESTAURANT  
DREXEL HEATING CO.  
ECONOMY SAVINGS & LOAN  
FRANCES DRESS SHOP  
HIPPLER PAINTERS  
HOLDEN REALTY  
HOUGH BAKERY  
HIKE RUBBER CO.  
INTORCIO'S CASINO  
KIRTRIDGE INN  
KLEIFELD RESTAURANT  
KOSTER'S SWEET SHOP  
LAKE FINANCE  
LEONELLO'S RESTAURANT & BAR  
LORIEUX HOTEL  
LUMBER & TRIM, INC.  
MEL'S GIFT & CARD SHOP  
MILMINE SEWING MACHINE &  
APPLIANCE CENTER  
OLSON'S SADDLERY  
P-Z SHOE SERVICE & REPAIRS  
PAGE, L. A. & SON  
PROKOP, J. L. & SONS  
ROLLER BOWL  
ROMA CAFE  
STALKER SERVICE STATION

TOM'S SONOCO STATION  
TODD-WHINNERY-ALLEN & ASSOC.  
TOWN HOUSE  
UNITED FOOD MGT. SERVICE, INC.  
WACHS ICE & FUEL  
WACO'S RESTAURANT  
WEATHER-LOCK CO.  
WILLOBY LOUNGE BAR  
WILLOUGHBY CAB  
WILLOUGHBY COAL & SUPPLY  
WILLOUGHBY FROZEN FOODS  
WILLOUGHBY FRUIT MARKET  
WILLOUGHBY GAS & OIL CO.  
WILLOUGHBY PHOTO SUPPLY  
WILLOUGHBY PRINTING CO.  
YOLANDA'S BEAUTY SHOP

### PROFESSIONAL

DR. A. A. ARCARO  
DR. S. K. CARPENTER  
NORMAN CHASE  
JOHN CLAIR, JR.  
ROBERT A. CLAIR  
WAYNE DAVIS  
ROGER ELSON  
DR. PAUL D. FERRIS  
RALPH V. GREENE  
DR. RAYMOND GREINER  
DR. R. W. GRUNDISH  
JOHN GUROY  
DR. C. W. HAGESFELD  
LA VERNE A. HEINZ  
DR. HARRY HUSTON, JR.  
DR. HARRY KILLIAN  
DR. RICHARD KOCHER  
DR. IMRICH KOVACHS  
DR. E. LASH  
DR. A. MAHAN  
DR. J. E. McCRACKEN  
DR. S. E. MILLER  
DR. RALPH NELSON  
ORGEL & HUNTER  
DR. O. L. PATTERSON  
DR. WARREN PAYNE  
FRANK SACHER  
DR. GEORGE SCOTT  
DR. M. M. STETSON  
DR. FLORENCE TAKACY  
DR. BENNET VANCE  
DR. HERBERT WELLS

FOR ALL YOUR FLOWER

## NEEDS COME TO STEWART'S GARDEN AND FLOWER MART

JUST WEST OF SOM

WILLOUGHBY HILLS

WH-3-5554



STUD

## LEWAY

## H & H CY

33520 VINE STREET

EASTLAKE, OHIO

PHONE WH-2-5636

"SATISFACTION GUARANTEED  
SINCE 1945"



Members of

# WILLOUGHBY CONSOLIDATED CHARITY AND SERVICE FUND

This fund sponsored by the Willoughby Chamber of Commerce

## NUMERICAL MERCANTILE OR SERVICE SMALL MERCANTILE OR SERVICE

AMERICAN FRUIT GROWERS PUB. CO.  
 BAKER DRUG  
 BOWER BROS. FEED & SUPPLY  
 BRINSON'S STORE FOR MEN  
 BRYANT LOAN & SAVINGS CO.  
 BRUNGER MOTOR SALES, INC.  
 BURCHMAN, J. P. CO.  
 BURMAN-YOUNG MOTORS  
 BURTON BROS. FUEL CO.  
 BURLEY & GRESSEL FOODS  
 BURMAN AVIATION INC.  
 BURR KIRBY CO.  
 BURR & J HARDWARE  
 BURDROVE REALTY  
 BURMAN'S DRY CLEANING  
 BURMAN PACKARD  
 BURR SHOES, INC.  
 BURTON FURNITURE  
 BURR BROS.  
 BURR SHORE LUMBER CO.  
 BURR'S TRAILER PARK  
 BURR'S FIRESTONE  
 BURR'S DEPARTMENT STORE  
 BURR'S SHOE STORE  
 BURR'S TELEGRAPH  
 BURR'S OLDSMOBILE CO.  
 BURR, H. F. STORE  
 BURR, J. A. & SON  
 BURR FURNITURE  
 BURR'S FOOD MARKET  
 BURR & COUNTRY TV APPLIANCES  
 BURR'S BEVERAGE STORE  
 BURR'S AUTO ACCESSORIES  
 BURR'S FASHION SHOP  
 BURR'S TERMINALS CO.  
 BURR'S DEPARTMENT STORE

BARNES SEED & SUPPLY CO.  
 BEVERLY FROCKS  
 BRANDT CANDY KITCHEN  
 BRICHFORD SHELL SERVICE  
 CARROLL'S SWEET SHOP  
 CLARK & PIKE CO.  
 COTTRELL'S NEWS STAND  
 DAINTEE BEAUTY SHOP  
 DAY-ED JEWELERS  
 DISBRO, R. M. INSURANCE  
 DOT RESTAURANT  
 DREXEL HEATING CO.  
 ECONOMY SAVINGS & LOAN  
 FRANCES DRESS SHOP  
 HIPPLER PAINTERS  
 HOLDEN REALTY  
 HOUGH BAKERY  
 HIKE RUBBER CO.  
 INTORCIO'S CASINO  
 KIRTRIDGE INN  
 KLEIFELD RESTAURANT  
 KOSTER'S SWEET SHOP  
 LAKE FINANCE  
 LEONELLO'S RESTAURANT & BAR  
 LORIEUX HOTEL  
 LUMBER & TRIM, INC.  
 MEL'S GIFT & CARD SHOP  
 MILMINE SEWING MACHINE & APPLIANCE CENTER  
 OLSON'S SADDLERY  
 P-Z SHOE SERVICE & REPAIRS  
 PAGE, L. A. & SON  
 PROKOP, J. L. & SONS  
 ROLLER BOWL  
 ROMA CAFE  
 STALKER SERVICE STATION

TOM'S SONOCO STATION  
 TODD-WHINNERY-ALLEN & ASSOC.  
 TOWN HOUSE  
 UNITED FOOD MGT. SERVICE, INC.  
 WACHS ICE & FUEL  
 WACO'S RESTAURANT  
 WEATHER-LOCK CO.  
 WILLOBY LOUNGE BAR  
 WILLOUGHBY CAB  
 WILLOUGHBY COAL & SUPPLY  
 WILLOUGHBY FROZEN FOODS  
 WILLOUGHBY FRUIT MARKET  
 WILLOUGHBY GAS & OIL CO.  
 WILLOUGHBY PHOTO SUPPLY  
 WILLOUGHBY PRINTING CO.  
 YOLANDA'S BEAUTY SHOP

## PROFESSIONAL

DR. A. A. ARCARO  
 DR. S. K. CARPENTER  
 NORMAN CHASE  
 JOHN CLAIR, JR.  
 ROBERT A. CLAIR  
 WAYNE DAVIS  
 ROGER ELSON  
 DR. PAUL D. FERRIS  
 RALPH V. GREENE  
 DR. RAYMOND GREINER  
 DR. R. W. GRUNDISH  
 JOHN GUROY  
 DR. C. W. HAGESFELD  
 LA VERNE A. HEINZ  
 DR. HARRY HUSTON, JR.  
 DR. HARRY KILLIAN  
 DR. RICHARD KOCHER  
 DR. IMRICH KOVACHS  
 DR. E. LASH  
 DR. A. MAHAN  
 DR. J. E. McCracken  
 DR. S. E. MILLER  
 DR. RALPH NELSON  
 ORGEL & HUNTER  
 DR. O. L. PATTERSON  
 DR. WARREN PAYNE  
 FRANK SACHER  
 DR. GEORGE SCOTT  
 DR. M. M. STETSON  
 DR. FLORENCE TAKACY  
 DR. BENNET VANCE  
 DR. HERBERT WELLS

FOR ALL YOUR FLOWER

NEEDS COME TO

# STEWART'S GARDEN AND FLOWER MART

JUST WEST OF SOM

WILLOUGHBY HILLS

WH-3-5554

STUDENT COUNCIL

OF

1957

COMPLIMENTS

OF

## LEWAYNES FLORIST

# H & H CYCLE-MOWER-MARINE

33520 VINE STREET

EASTLAKE, OHIO

PHONE WH-2-5636

"SATISFACTION GUARANTEED SINCE 1945"

- BICYCLES
- HOBBIES
- MODELS
- CRAFTS
- MOTOR-CYCLES
- MOTOR-SCOOTERS
- POWER-MOWERS
- CHAIN-SAWS
- ROTARY-TILLERS
- MARINE SUPPLIES
- OUTBOARD MOTORS
- PAINTS
- BOATS
- TRAILERS





Compliments

of

F. M. WILLIAMS HARDWARE

1088 Lost Nation Road  
Willoughby, Ohio

CONGRATULATIONS TO THE CLASS

of

1957

Mrs. Ann Rauker

BEST WISHES

FROM

**WILLOUGHBY HIGH SCHOOL**

**FACULTY**

COMPLIMENTS OF

**ROGERS BI-RITE**

**SUPER MARKETS**

33204 VINE STREET  
EASTLAKE, OHIO

CHILLICOTHE RD (RT306)  
KIRTLAND, OHIO

Good Luck To The

SENIOR CLASS

HI - Y

ELSNER'S FLORIST  
"Finest In Florist Fashions"

33009 Vine Street

Willowick, Ohio

Phone WH-3-1887  
WH-3-5417

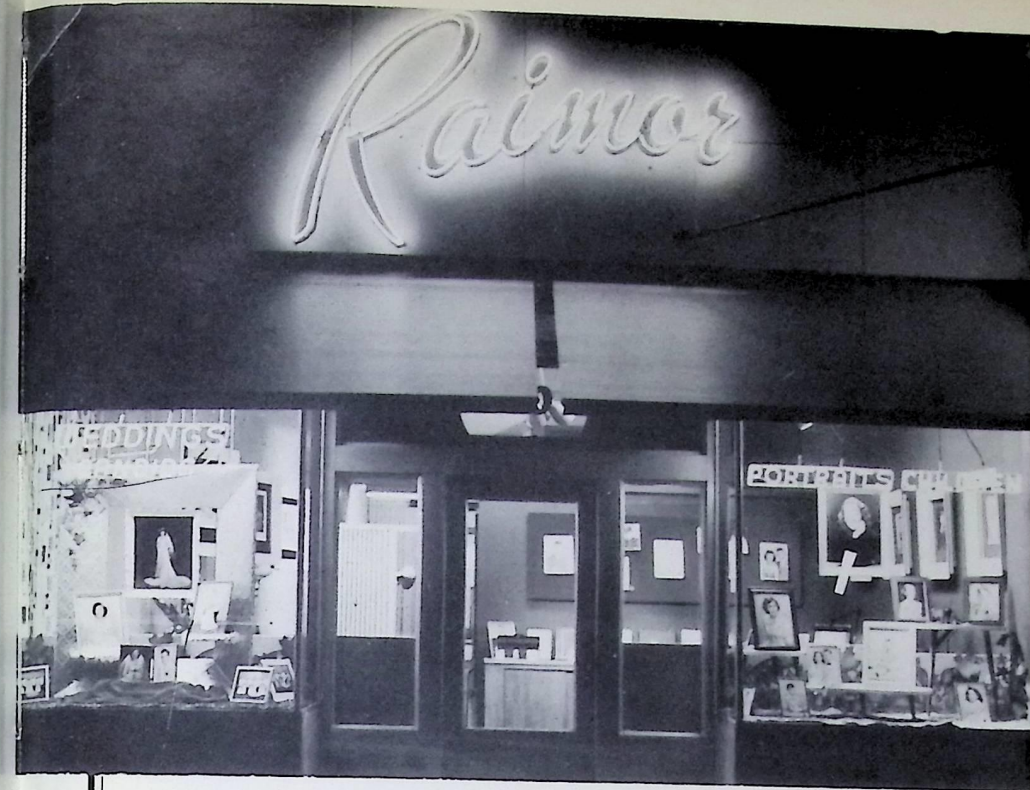

BEST WISHES TO THE CLASS

OF 1957

**RAIMOR STUDIOS**

750 E. 185

CLEVELAND, OHIO

OFFICIAL CLASS PHOTOGRAPHER



CONGRATULATIONS & B

TO THE CLASS OF

**JUDD'S RESTAU**

DAILY LUNCHEON SP

BAR-B-Q-RIBS - COMPLE  
SANDWICHES

WH-3-4349

3055 E



AMS HARDWARE  
Nation Road  
hby, Ohio

ONS TO THE CLASS  
of  
1957  
Mrs. Ann Rauker

WISHES  
FROM

HIGH SCHOOL  
CULTY

COMPLIMENTS OF

# ROGERS BI-RITE

## SUPER MARKETS

33204 VINE STREET  
EASTLAKE, OHIO

CHILlicoTHE RD (RT306)  
KIRTLAND, OHIO

Good Luck To The  
SENIOR CLASS  
HI - Y

ELSNER'S FLORIST  
"Finest In Florist Fashions"

33009 Vine Street  
Willowick, Ohio

Phone WH-3-1887  
WH-3-5417

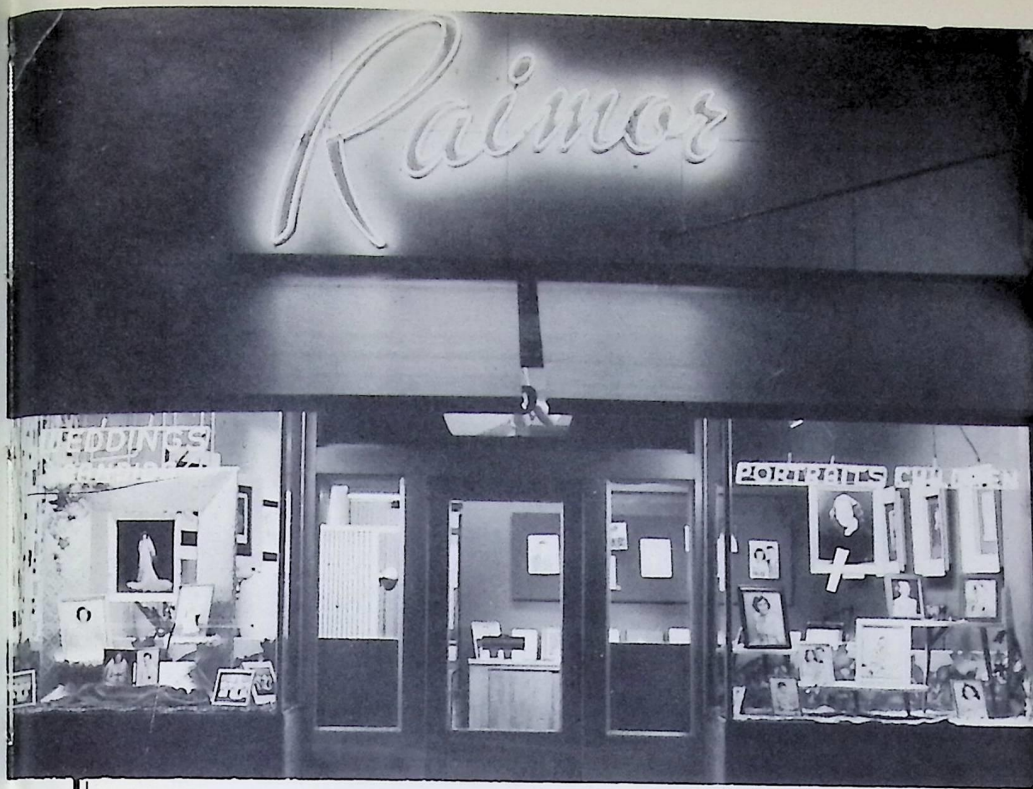

BEST WISHES TO THE CLASS

OF 1957

# RAIMOR STUDIOS

750 E. 185

CLEVELAND, OHIO

OFFICIAL CLASS PHOTOGRAPHER



CONGRATULATIONS & BEST WISHES

TO THE CLASS OF 1957

# JUDD'S RESTAURANT, INC.

DAILY LUNCHEON SPECIALS

BAR-B-Q-RIBS - COMPLETE DINNERS  
SANDWICHES

WH-3-4349 3055 EUCLID AVE.

WE WISH YOU SUCCESS IN THE FUTURE  
 MAY YOU PUT TO GOOD USE THE KNOWLEDGE  
 FOR WHICH YOU HAVE STRIVED IN THE PAST  
 FOUR EVENTFUL YEARS

## LAKE RUBBER COMPANY, INC.

Compliments  
 of  
 THELMA

Bob Merkel Florist  
 38126 Second Street  
 Willoughby Ohio

EUCLID BODY AND FENDER CO.  
 38794 Mentor Ave.  
 Complete Body & Fender Repair  
 Satisfaction Guaranteed

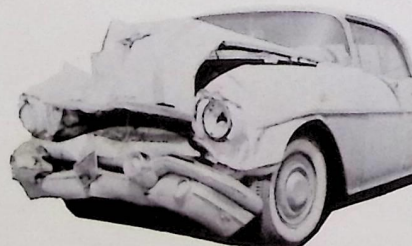

WH-2-4522

Compliments

of

## PETE OATESS PONTIAC

DAVIS  
 FUNERAL  
 HOME

Good Luck Class

COMPLIMENTS

OF

## A FRIEND

## SHOPPING IS "SHORE" EASY AT SHOREGATE!

COMPLIMENTS

1957

THE BANDSTAND  
 THE CAROUSEL SHOP  
 CLEAR SYLK  
 CLEVELAND FABRIC SHOPS  
 D. O. SUMMERS DRY CLEANING  
 FAMILY STAMPS  
 FISHER FOODS  
 FOODTOWN  
 F. W. WOOLWORTH  
 GARFINKEL SHOES  
 GEO. MAWBY'S RESTAURANT  
 GREENHUT GIFTS  
 HORTON NURSERIES  
 KAASE BAKERY  
 KINKOPF MEATS  
 LAKE COUNTY NATIONAL BANK  
 LAUREL CAMERA SHOP

MARSHALL DRUG  
 MARY'S STYLE SHOP  
 MILES SHOES  
 NEW YORK BAKERY  
 PETER PAN DRESS SHOP  
 SHOREGATE BARBER SHOP  
 SHOREGATE HARDWARE  
 SHOREGATE JEWELRY  
 SHOREGATE MEDICAL BLDG.  
 SHOREGATE OPTICAL  
 SHOREGATE RESTAURANT  
 SHOREGATE SHOE REPAIR  
 SLENDERELLA  
 STERLING CARPET  
 SWIFT DRY CLEANING  
 THOMAS COIFFEURS  
 WINDSOR MEN'S SHOP

LEN  
 STA

ESS IN THE FUTURE  
GOOD USE THE KNOWLEDGE  
AVE STRIVED IN THE PAST  
ARS

Compliments

of

# PETE OATESS PONTIAC

DAVIS  
FUNERAL  
HOME

Good Luck Class

## COMPANY, INC.

Compliments

of

THELMA

Merkel Florist  
6 Second Street  
Coughby Ohio

COMPLIMENTS

OF

## A FRIEND



WH-2-4522

## SHOPPING IS "SHORE" EASY AT SHOREGATE!

THE BANDSTAND  
THE CAROUSEL SHOP  
CLEAR SYLK  
CLEVELAND FABRIC SHOPS  
D. O. SUMMERS DRY CLEANING  
FAMILY STAMPS  
FISHER FOODS  
FOODTOWN  
F. W. WOOLWORTH  
GARFINKEL SHOES  
GEO. MAWBY'S RESTAURANT  
GREENHUT GIFTS  
HORTON NURSERIES  
KAASE BAKERY  
KINKOPF MEATS  
LAKE COUNTY NATIONAL BANK  
LAUREL CAMERA SHOP

MARSHALL DRUG  
MARY'S STYLE SHOP  
MILES SHOES  
NEW YORK BAKERY  
PETER PAN DRESS SHOP  
SHOREGATE BARBER SHOP  
SHOREGATE HARDWARE  
SHOREGATE JEWELRY  
SHOREGATE MEDICAL BLDG.  
SHOREGATE OPTICAL  
SHOREGATE RESTAURANT  
SHOREGATE SHOE REPAIR  
SLENDERELLA  
STERLING CARPET  
SWIFT DRY CLEANING  
THOMAS COIFFEURS  
WINDSOR MEN'S SHOP

COMPLIMENTS OF THE

1957

# LENS STAFF



**FINIS**

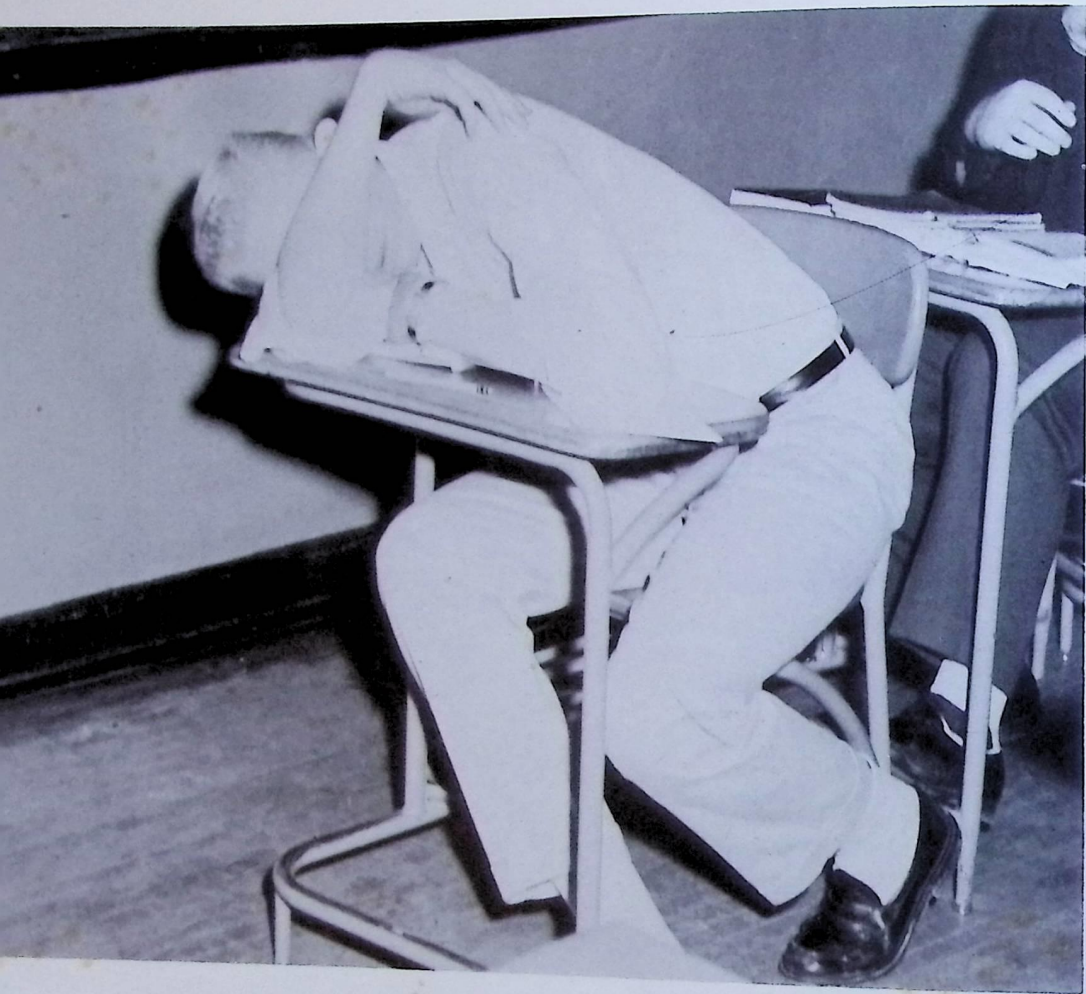

**FINIS**



NORTH HIGH SCH

6/5/50

